

Application Guide

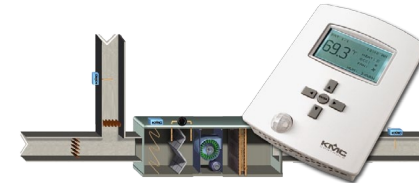

Contents

General Information (All Output Configurations)	3	Displaying Other Objects.....	19
Overview and General Installation.....	4	Mapping Analog Inputs or Outputs as Binary.....	20
Mounting Considerations	4	Motion Sensor Applications.....	20
Wiring Considerations.....	4	Using Sensors Connected to Other Controllers.....	20
Inputs and Outputs	5	CO ₂ Sensors and DCV	21
Connecting Standard Inputs.....	5	Principles of Operation	21
4–20 mA Current Input	6	CO ₂ Sensor Calibration	22
Calibrating a (Temperature) Sensor	7	Custom Web Graphics.....	24
Filter Weight (Input “Smoothing”).....	9	Hospitality and Locked User Interface Modes.....	25
Connecting Outputs	13	Selecting UI Modes	25
Configuration Screens	13	Reverting UI Modes	26
Custom Programming.....	14	Resetting Hospitality Mode Setpoints to Defaults	27
General	14	Programming Custom Text for Hospitality Mode	28
Viewing the Control Basic Programs	14	Motion/Occupancy Sensor.....	29
Modifying the Standard Control Basic Programs	15	Performance and Applications.....	29
Custom Objects Restrictions/Recommendations.....	16	Enabling/Disabling the Sensor and Override Time.....	30
Programs During Upgrades and Factory Restores.....	16	Customizing the Motion Sensor and Override	30
Sample Custom Applications.....	17	Adding a Door Contact for Additional Control.....	31
Adding a Remote Temperature Sensor to an Input.....	17	Adding Remote Motion Sensors	32
Displaying the Current Setpoint	18	Troubleshooting Motion Sensor Operation.....	33
Displaying Outside Air Temperature	19	Support	33
		Important Notices.....	33

BAC-1xx63/1xxx63 Series (6 Relays and 3 Analog Outputs)	34
Bills of Materials (BAC-1xx63/1xxx63).....	35
AHU (Air Handling Unit)—Modulating Heat and Modulating Cool.....	35
HPU (Heat Pump Unit)—1 or 2 Compressors w/ Aux. & Emergency Heat.....	36
RTU (Roof Top Unit)—1 or 2 Heat and 1 or 2 Cool.....	36
FCU (Fan Coil Unit)—2 or 4 Pipe, Modulating or 2 Position.....	37
Sequence of Operation (BAC-1xx63/1xxx63).....	38
FlexStat (All Models) Common Features.....	38
Space Temperature Setpoints and Modes.....	38
Occupancy Modes.....	39
Optimum Start.....	40
Standby Mode.....	40
Fan Control.....	41
Sensor 2 (Fan Status or Discharge Air Temp).....	41
Economizer.....	41
DCV (Demand Controlled Ventilation)—General Information.....	42
DCV—Basic Configuration.....	43
DCV—Standard Configuration.....	43
DCV—Advanced Configuration.....	44
Dehumidification.....	46
Humidification (BAC-1x136 and BAC-1xx136 Only).....	46
Staged Heating and Cooling Parameters.....	47
User Interface Display Backlight.....	47
BAC-1xx63/1xxx63 Applications.....	47
AHU (Air Handling Unit).....	47
HPU (Heat Pump Unit).....	48
FCU (Fan Coil Unit), 2-Pipe.....	50
FCU (Fan Coil Unit), 4-Pipe.....	51
RTU (Roof Top Unit).....	52

BAC-1xx36/1xxx36 Series (3 Relays and 6 Analog Outputs)	53
Bills of Materials (BAC-1xx36/1xxx36).....	54
AHU (Air Handling Unit)—Multiple H/C Options.....	54
FCU (Fan Coil Unit)—2 or 4 Pipe, Modulating.....	56
Sequence of Operation (BAC-1xx36/1xxx36).....	57
BAC-1xx36/1xxx36 Common Features.....	57
BAC-1xx36/1xxx36 Series Applications.....	57
AHU (Air Handling Unit).....	57
Staged Heating and Cooling Parameters.....	58
Economizer Control.....	59
FCU (Fan Coil Unit), 2-Pipe.....	60
FCU (Fan Coil Unit), 4-Pipe.....	61
BAC-1xx30 Series (3 Relays and 0 Analog Outputs)	62
Bills of Materials (BAC-1xx30).....	63
AHU (Air Handling Unit)—1 Heat and 1 Cool.....	63
Cooling Unit—1 Cool.....	63
Heating Unit—1 Heat.....	63
HPU (Heat Pump Unit)—1 Compressor.....	63
Sequence of Operation (BAC-1xx30).....	64
BAC-1xxx53 (5 Relays, 1 Triac, & 3 Analog Outputs)	65

NOTE: The material in this document is for information purposes only. **The contents and the product it describes are subject to change without notice.**

General Information (All Output Configurations)

This document gives wiring details, schematics of sample applications (including bills of material with KMC Controls products), and other related information for the award-winning FlexStat. This document is divided into:

- This general information section
- A section specific to the BAC-1xx63 and BAC-1xxx63 series (with 6 relays and 3 analog outputs)
- A section specific to the BAC-1xx36 and BAC-1xxx36 series (with 3 relays and 6 analog outputs)
- A section specific to the BAC-1xx30 series (with 3 relays and 0 analog outputs—no BAC-1xxx30 series is offered)

Models with the extra number have three additional inputs and options for CO₂ sensing (BAC-13xxxx and BAC-14xxxx) and IP network connections (BAC-1xxxxxE).



**BAC-1xxxx or
BAC-12xxxx
FlexStat
without CO₂
Sensor**



**BAC-13xxxx
and BAC-14xxxx
FlexStat with
CO₂ Sensor**

NOTE: For specifications on the (six-external-input models), see the [BAC-12xxxx/13xxxx/14xxxx Series FlexStat Data Sheet](#) (914-035-01). For specifications on the older [BAC-10000 Series FlexStats](#) (with only three external inputs and no Ethernet or CO₂ options), see the data sheet (913-035-01) for that series.



(Click for details.)



Overview and General Installation

This document gives wiring details, schematics of sample applications (including bills of material with KMC Controls products), and other related information.

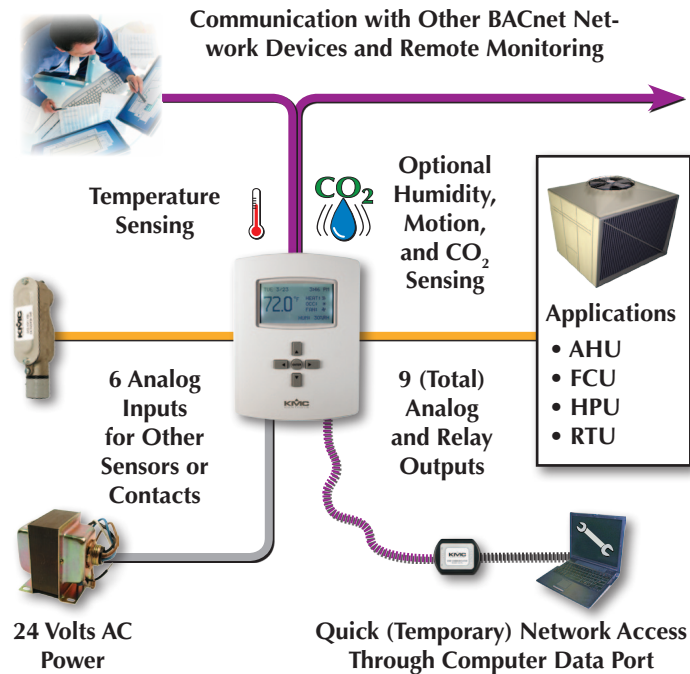

Overview

Wire the FlexStat to the desired equipment (see below for general purpose wiring and switch configuration) and select the relevant program from the (Advanced) Application submenu of the Advanced Menu and other appropriate menus.

For general mounting and connection details, including network wiring, EOL termination, power connections, input/output connections, pull-up resistor switch settings, see the relevant FlexStat Installation Guide.

For configuration, operation, and troubleshooting information, see the [FlexStat Operation Guide](#).

Mounting Considerations

FlexStats must NOT be:

- Mounted on an exterior wall.
- Mounted on or near a large thermal mass (e.g., concrete block wall).
- Blocked from normal air circulation by obstructions.
- Exposed to heat sources (e.g., lights, computers, copiers, or coffee makers) or to sunlight (at **any** time of the day).
- Exposed to drafts from windows, diffusers, or returns.
- Exposed to air flow through the conduit (from leaks in plenum ducts)—put plumber’s putty or similar material inside the conduit to block air flow.

Wiring Considerations

Because of the many connections (power, network, inputs, outputs, and their respective grounds or switched commons), **be sure wiring is well planned before installation of conduit!**

⚠ CAUTION

To avoid damage from ground loops and other communication issues in networked FlexStats, correct phasing on network and power connections on ALL the networked controllers is critically important.

- To prevent excessive voltage drop, **use a conductor size that is adequate for the wiring length! Allow plenty of “cushion” to allow for transient peaks during startup.**
- Make sure that conduit for all wiring has adequate diameter for all necessary wiring. Using 1-inch conduit and junction boxes is recommended!
- Use external junction boxes above the ceiling or in another convenient location as needed to make connections that run to the FlexStat’s junction box.
- Using multiple conductor wires for all inputs (e.g., six conductor) and outputs (e.g., 12 conductor) is recommended. Grounds for all the inputs can be combined on one wire.

Inputs and Outputs

Connecting Standard Inputs

Supported input devices include:

- Active 0–12 VDC devices
- Passive contacts
- 10K ohm thermistors (Type III or Type II can be selected using the Inputs menu)

Unsupported input devices include:

- 1K ohm RTDs
- Directly connected 4–20 mA devices—but they can be connected as voltage inputs across an external resistor (see below for information)

Passive input devices require pull-up resistors, which can be switched on inside the thermostat. For **passive** input devices (e.g., switch contacts and 10K ohm thermistors), set the pull-up switch on the back of the circuit board to the **10K** position. For **active** voltage devices, set the switch to the **0–12 VDC** position.

Be sure pull-up resistor switches are set correctly. Having both pull-up switches to the left can potentially result in oscillating readings that can even affect other inputs. Having both to the right may result in readings that are only about 1/4 the proper value.

NOTE: ALL the input pull-up resistor switches must be fully latched in the correct positions. See the Connections and Wiring section of the relevant FlexStat Installation Guide. **A single incorrect switch position may affect multiple inputs. All input switches must be latched in either 10K Ohm or 0–12 VDC positions even if no input is connected! Input switch pairs must never have both switches set to the left or both to the right—if one of the switch pairs is set to the left, for example, the other must be set to the right (or vice versa).**

NOTE: Analog inputs can be mapped as binary values in Control Basic (using BACstage or TotalControl). Set an analog voltage less than 0.5 VDC to equal a binary Off state and an analog voltage of 0.5 to 12 VDC to equal a binary On state. See [Mapping Analog Inputs or Outputs as Binary on page 20](#).

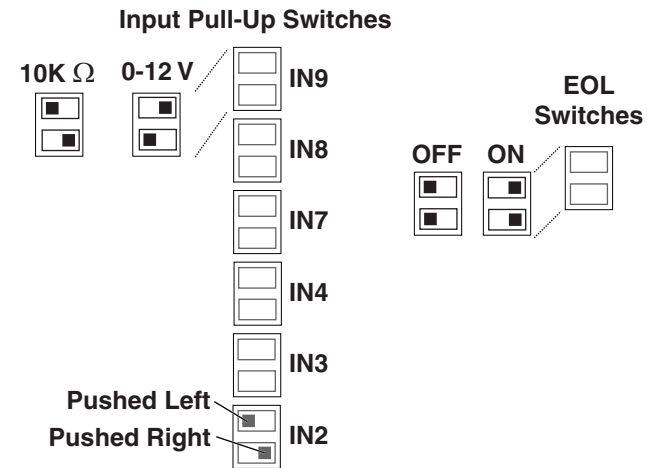

BAC-1xxxxx EOL and Pull-Up Resistor Switch Positions

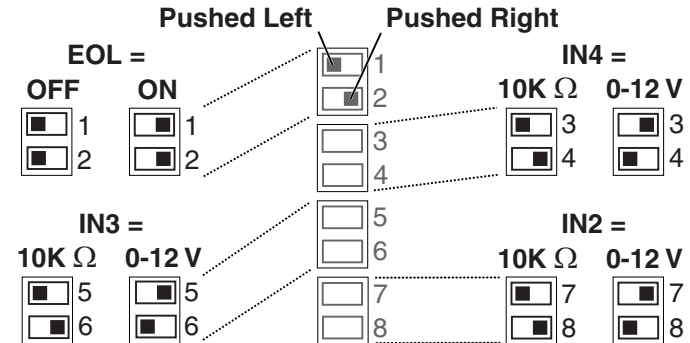

(Older) BAC-1xxxx EOL and Pull-Up Resistor Switch Positions

NOTE: See also the terminal illustrations for:

- [BAC-1xx63/1xxx63 Series \(6 Relays and 3 Analog Outputs\) on page 34.](#)
- [BAC-1xx36/1xxx36 Series \(3 Relays and 6 Analog Outputs\) on page 53.](#)
- [BAC-1xx30 Series \(3 Relays and 0 Analog Outputs\) on page 62.](#)

4–20 mA Current Input

To use a **4–20 mA current input**:

1. Connect an **external 250 ohm resistor** from input to ground. (Do not install the resistor inside the FlexStat's case since the heat generated by the resistor may skew the temperature readings.) The resistor converts the 4–20 mA current input to a 1–5 VDC voltage that can be read by the thermostat's analog-to-digital converter.

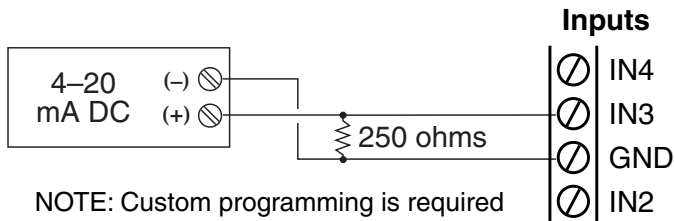

External 250 Ohm Resistor for 4–20 mA Current Inputs

2. Set the corresponding pull-up switches to the **0–12 VDC** position.

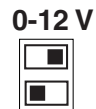

Input Pull-Up Switches Set to 0–12 VDC

3. Using BACstage or TotalControl, configure the input device type for a 4–20 mA source.

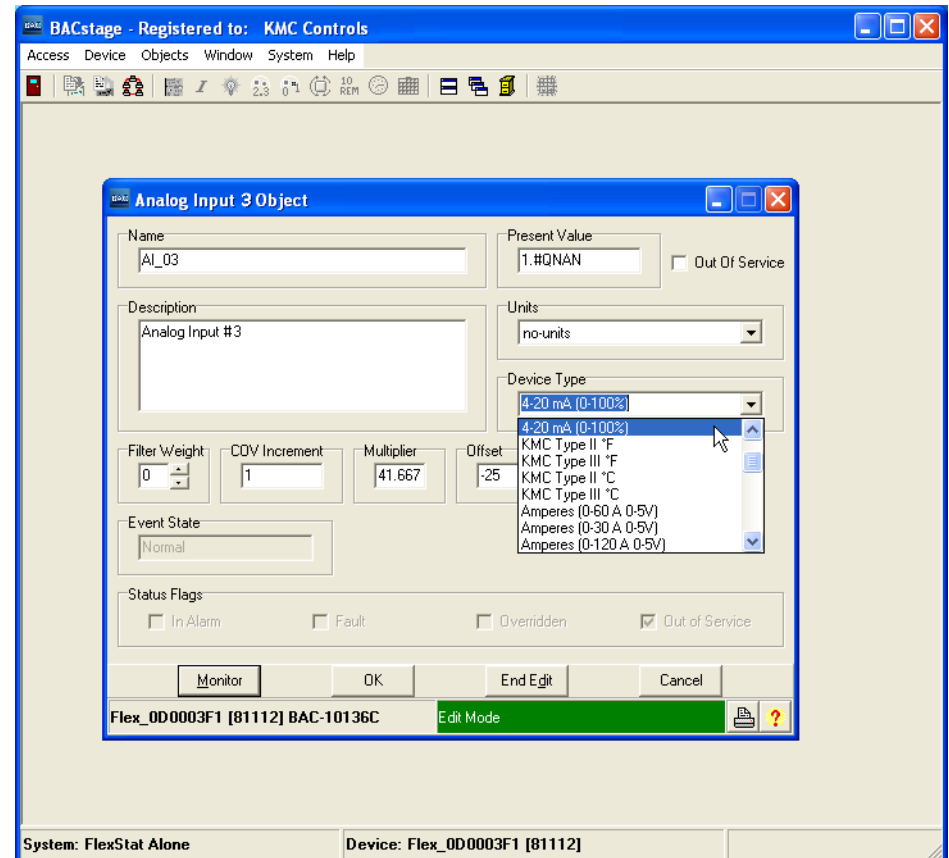

Analog Input Configuration (in BACstage)

Calibrating a (Temperature) Sensor

This section describes checking and calibrating the internal temperature sensor, but other analog sensors can be calibrated in an analogous manner. For maximum accuracy, **wait at least a half hour after initial power-up before checking or performing calibration of the INTERNAL temperature sensor!**

NOTE: **Mounting location can greatly affect accuracy!** See [Mounting Considerations on page 4](#). Other issues may affect temperature accuracy—see the Troubleshooting section in the [FlexStat Operation Guide](#).

NOTE: With firmware version R2.0.0.21 and later, a FlexStat's temperature reading starts out too "cold" and becomes "warmer" until stabilizing at maximum accuracy. The difference is more pronounced in the BAC-13xxxx/14xxxx CO₂ models.

NOTE: With R2.0.0.13 and later firmware, Fahrenheit temperature values on the display change in whole degree increments by default, and Celsius values change in 0.5° increments. Changing the default *No* to *Yes* will show tenths of a degree values for both scales. (This does not affect setpoint adjustments, which are always in whole degree increments for Fahrenheit and half degree increments for Celsius.) For calibration purposes, temporarily changing the *No* to *Yes* for Show Temp Tenths may be desirable.

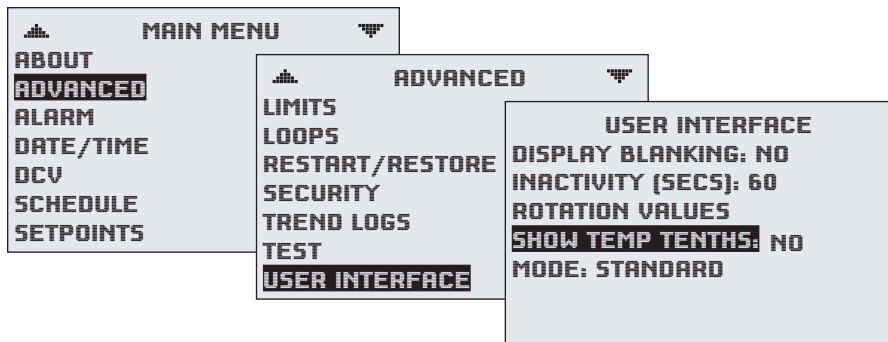

NOTE: For calibrating a BAC-14xxxx CO₂ sensor with gas, see [CO₂ Sensor Calibration on page 22](#).

To CHECK space temperature calibration:

1. After an initial power-up, wait at least a half hour before calibrating the FlexStat.
2. Carefully position an accurate thermometer or temperature probe next to the FlexStat and (after sufficient time for the thermometer or probe to stabilize) compare readings.

NOTE: Body heat can affect the temperature of the FlexStat and/or a thermometer.

3. If there is an undesirable discrepancy, the space temperature calibration offset value of AI1 (the internal space temperature sensor) can be changed in the FlexStat menu or BACstage or TotalControl.

The calculation is New FlexStat Offset = Existing FlexStat Offset + Meter Temp – FlexStat Temp. For example, if the FlexStat is reading 1.1 degrees too high, the New FlexStat Offset = [0 (Existing FlexStat Offset) + 75.1 (Meter Temp) – 76.2 (FlexStat Temp)] = -1.1.

NOTE: In firmware versions before R1.3.0.4, Fahrenheit readings had a default offset of 32. The method of temperature value calculation then changed, and the default offset is now 0.

To CALIBRATE the space sensor from the FlexStat MENU:

NOTE: For maximum accuracy after an initial power-up, let the FlexStat warm up for at least a half hour before calibration.

4. Press the *Right* arrow button until the Main Menu appears and then navigate through the Advanced > Inputs > Space Temp Sensor menus. (Enter a password as needed.)
5. Push the *Down* button and *Enter* button to select the Calibration Offset.
6. Use the *Up* and *Down* buttons to enter the appropriate offset value (e.g., -2.1) and press the *Enter* button to save.
7. Press the *Left* button until the home screen appears.

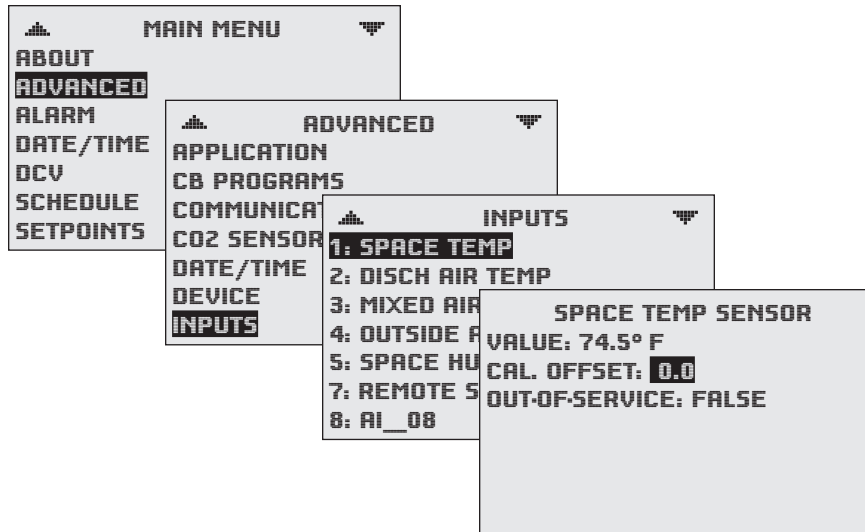

To CALIBRATE the space sensor using SOFTWARE (BACstage or TotalControl), navigate to the AI1 input object screen and change the Offset/Calibration value.

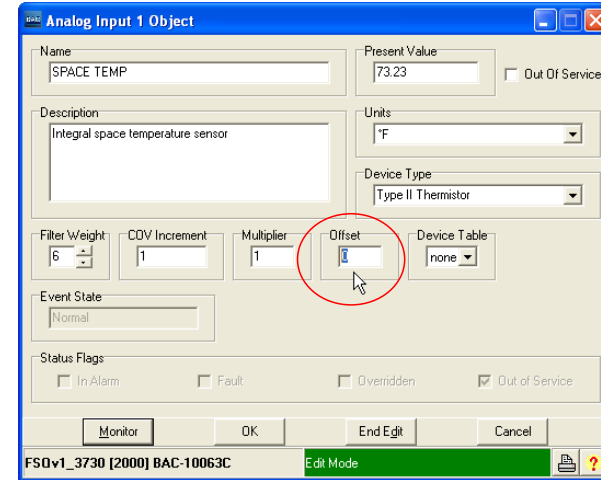

NOTE: In TotalControl, right-click in the Present Value field of the AI1 input object screen and select *Calibrate Present Value*.

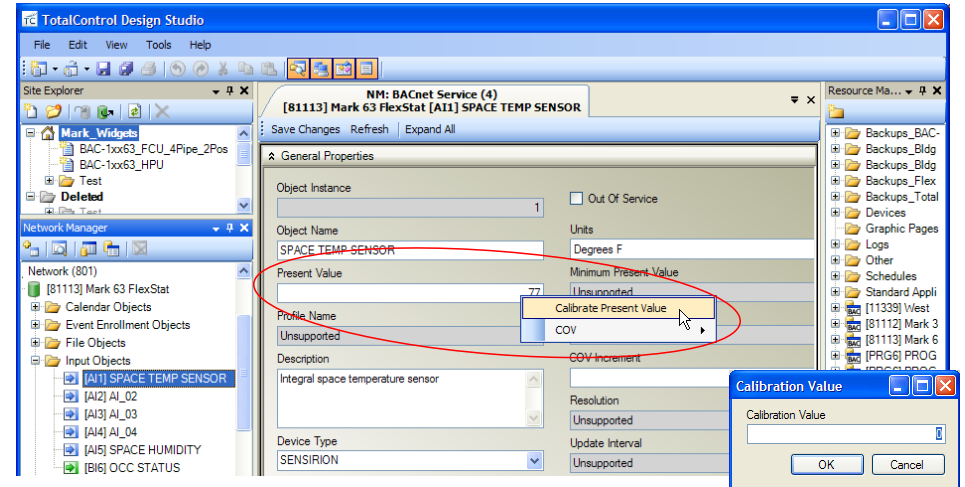

Filter Weight (Input “Smoothing”)

Introduction

Filter Weight smooths (dampens) input value readings, reducing sensitivity to signal noise and temperature spikes. Smaller filter weight values (more sensitive) cause the sensor readings to react more quickly to sudden changes, and larger values (more stable) cause sensor readings to react more slowly to sudden changes or noise. (See [Response Time Examples on page 11.](#))

Filter Weight values can be changed from the defaults in the FlexStat menu (in firmware version R2.0.0.21 or later) or in BACstage or TotalControl.

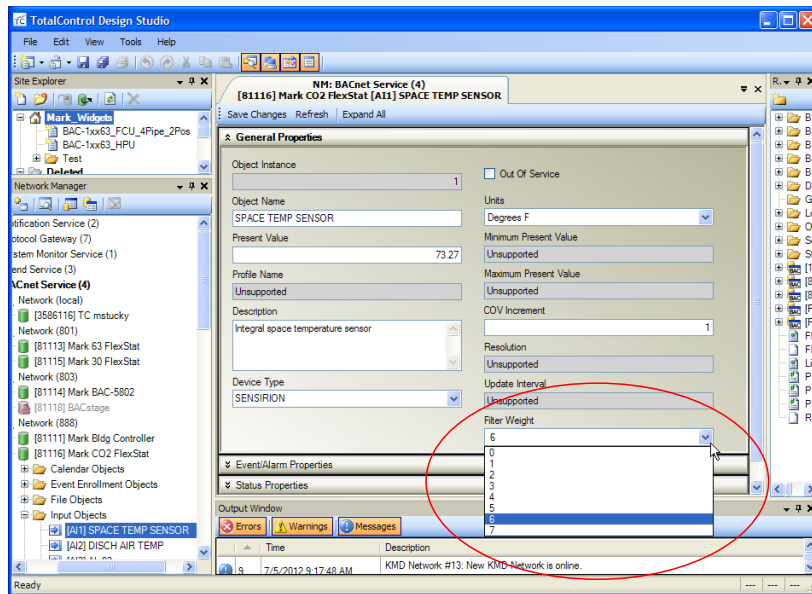
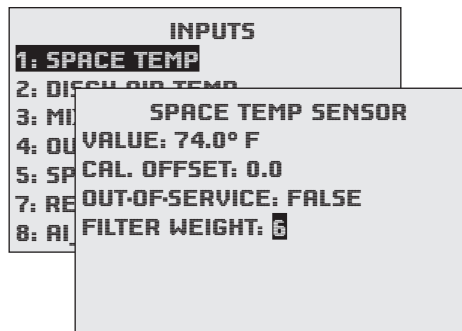

Areas subject to sudden swings of temperature from factors such as door openings and closings may benefit from adjusting the filter weight. Temporarily reducing filter weight may also be helpful for some diagnostic or commissioning purposes (but the defaults should be restored for normal operation). Although knowing “what’s under the hood” is not necessary for adjusting filter weight, this section gives a brief description of the sophisticated processing involved, followed by additional details and examples.

After the analog sensor signal is converted to a digital value, the value is processed through two types of filtering, and the resulting value is appropriately scaled. Additional details are:

1. After the Analog-to-Digital Converter (ADC) converts the voltage to a digital value, the first stage of filtering is a five-sample **median filter**. (See [Median Filter on page 9.](#))
2. The second stage of filtering is a first-order **Infinite Impulse Response (IIR) filter**, using a factor that is calculated based on the filter weight. (See [Infinite Impulse Response \(IIR\) Filter on page 10.](#))
3. The final displayed temperature value is calculated using the voltage scalar, multiplier, and offset. (See [Final Scaling on page 11.](#))

NOTE: These details are specific to the FlexStat, but the general filter weight principles apply to all digital controllers from KMC Controls.

Median Filter

The first stage of filtering is a five-sample median filter, which is designed to discard fast, false, extreme values caused by glitches, such as transient spikes, digital noise, and quantization outliers.

The firmware reads a 16-bit A/D sample every 250 milliseconds. The device remembers the last five Analog-to-Digital Converter samples, sorts them lowest to highest, and picks the sample in the middle. This is the median value. When the next sample is taken, the oldest sample of the previous five samples is removed from the buffer, and the new sample is added. The sort is done again, and the median sample is used. See [Median Filter Process on page 10.](#)

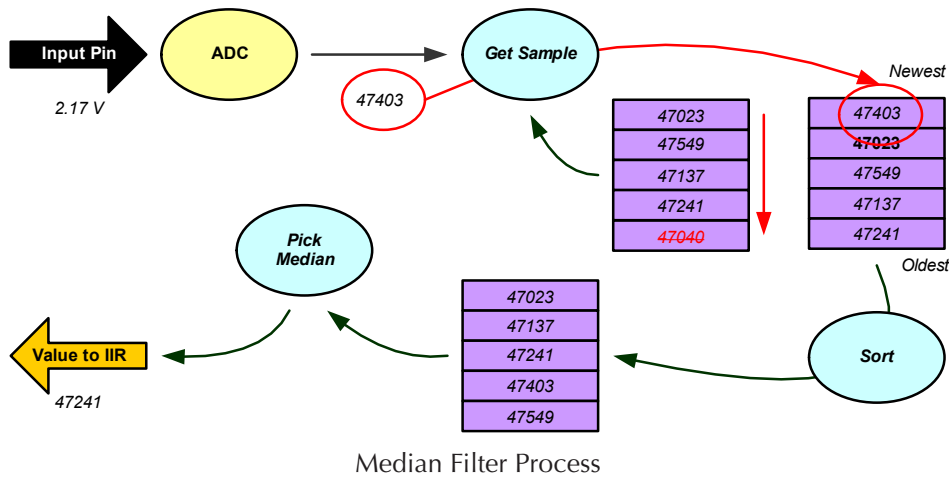

In this example, the five-sample buffer already has five samples. The ADC sees a 2.17 V signal, and converts this to a digital value of 47403 (due to the 16-bit A/D conversion and the 3.0 VDC reference in the FlexStat). The oldest of the five samples (47040) is dropped out the bottom, and the new sample is placed on top of the buffer. After a low-to-high sort, the value 47241 is found in the middle, and the median filter output is then 47241. (This value of 47241 happened to be the oldest of the five current samples in this case.)

Then a new sample is read and digitized by the ADC (47342, for example). Since 47241 was the oldest value, it drops out and 47342 is placed on the top. When the sort is done again, a new median value is selected (which happens to be 47342 in this case).

The median filter uses a “sliding window in time.” The FlexStat’s five-sample window represents 1250 milliseconds in time. One end of the window is always the current time, and the window “slides” to keep up with the current time. A sample that is older than 1250 milliseconds, slides outside of the window and is forgotten.

Infinite Impulse Response (IIR) Filter

The second stage in filtering calculates how quickly to respond to temperature changes. This stage is technically a first-order IIR, which is used as a low-pass filter. It calculates the new value based on the old input value plus the current input value, with the old value and the current value each being multiplied by a different weight factor.

Unlike the median filter, the IIR filter does not have a “window.” Rather, a weighted factor determines how much the current input will affect the filter’s output. For the FlexStat, this factor is selectable between eight different values, ranging from 0.78 to 100.0%:

Filter Weight		
Selected Value	Factor (a)	Percentage
0	1	100
1	1/2	50
2	1/4	25
3	1/8	12
4	1/16	6.25
5	1/32	3.125
6 (Default)	1/64	1.5625
7	1/128	0.78125

The Filter Weight factor uses the equation:

$$y_n = (1-a)y_{n-1} + ax_n$$

Where:

- x_n is the current sample from the median filter, which is the input to the IIR filter
- y_n is the current output of the IIR filter
- y_{n-1} is the previous output of the IIR filter
- a is the Filter Weight factor from the table (the Filter Weight’s default **selected value** is 6, or a factor of 1/64, or 1.5625%)

In the median filter example above, the value of our first cycle of the median filter was 47241. If the IIR filter had a value of 47239.7329 in its previous calculation, and the filter weight is 6, then when the new median filter output of 47241 is calculated, the new IIR filter's value is: $47239.7527 = (1-1/64)47239.7329 + 47241(1/64)$. In this example, a value of 47239.7527 comes out of the IIR filter.

Final Scaling

After the filtering is done, the firmware determines the voltage scalar (which may be a device table lookup), does the multiplier, and finally adds the offset to make the final value from the input.

If a device table is configured for the input, the firmware uses the output of the IIR as an index into the table (with some interpolation). Device tables have only 128 values, which means the index into the table ranges 1–128. The output of the IIR filter ranges between 0–65536. The firmware uses the Device Tables as follows:

1. Divide the current IIR value by 512 (called decimation).
2. Truncate this to use as an index into the Device Table (but remembering the remainder). In the example, $47239.7527/512 = 92$ with a remainder of 0.265142.
3. Add one to the whole part ($92 + 1 = 93$) because the IIR values start at 0 but the table indices start at 1.
4. If this is a Type II thermistor table, the value in the table at index 93 is 4.879391.
5. To interpolate, go to the next table value, which is index 94, and get its value (4.094612).
6. Calculate the difference between these two table values (-0.784779) and multiply this by the remainder in Step 2 (0.265142), which equals -0.208078 .
7. Add this to the first table value looked up in Step 4 (4.879391), which equals 4.671313. This is the input's value before the multiplier and offset.

If a device table is not being used, the input's value depends on the input pull-up switch position:

- For 10K Ohm: Input Value = $3 \cdot IIR/65535$
- For 12 VDC: Input Value = $12 \cdot IIR/65535$

NOTE: The IIR value here is what came out as a result of the IIR filtering, which is a digital value that goes up to 65535.

Whether the Input Value is from the Device Table or the simpler calculation, multiply it by the multiplier. From Step 7 (4.671313) of the example, the multiplier is 1.8 (for Fahrenheit) and the result is 8.40836.

The last step is to add the offset, which is 32.0 for Fahrenheit. For the example then, the temperature reading is 40.40836.

NOTE: Filtering out noise does not necessarily mean you are reading the whole input and nothing but the input. If noise has a very slow frequency component, for instance, an error will still be in the input values reported even after filtering.

Response Time Examples

Adding a weighted factor to the current input in the IIR delays the response in the output. The larger the Filter Weight value, the longer is the delay as shown in [Response to Door Opening and Closing on page 12](#). In this example, a heated shop with a large door is being maintained at a comfortable level. The door opens, allowing cold outside air in. After about a minute, the door closes.

In [Response to FlexStat Reset and Rapid Random Signal Noise on page 12](#), extreme, rapid, random noise from a wiring problem affects the signal. (In this case, smoothing out the noise is helpful, but it does not necessarily mean you are reading the whole input and nothing but the input.) Time delay is also shown in the responses after the reset (at 0). Larger filtering values (with slower responses) might appear to be a problem after the reset, but room temperature would never jump instantaneously from 0° to 70° in real life. Hence, wide discrepancies from true temperature are not a filter weight issue in normal operation.

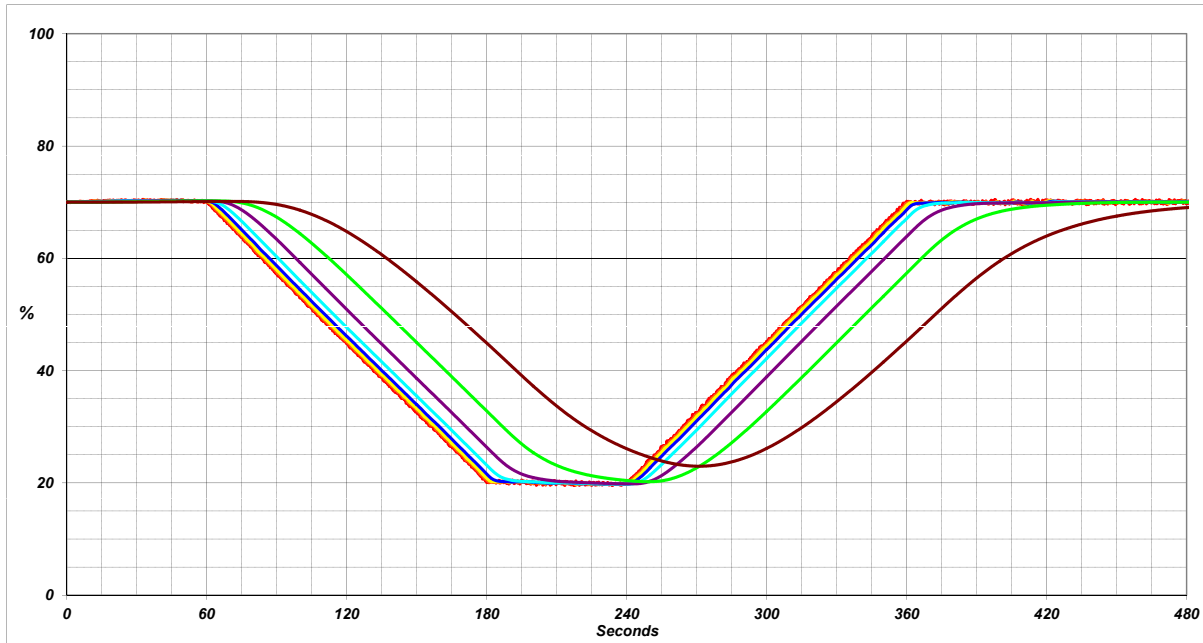

Response to Door Opening and Closing

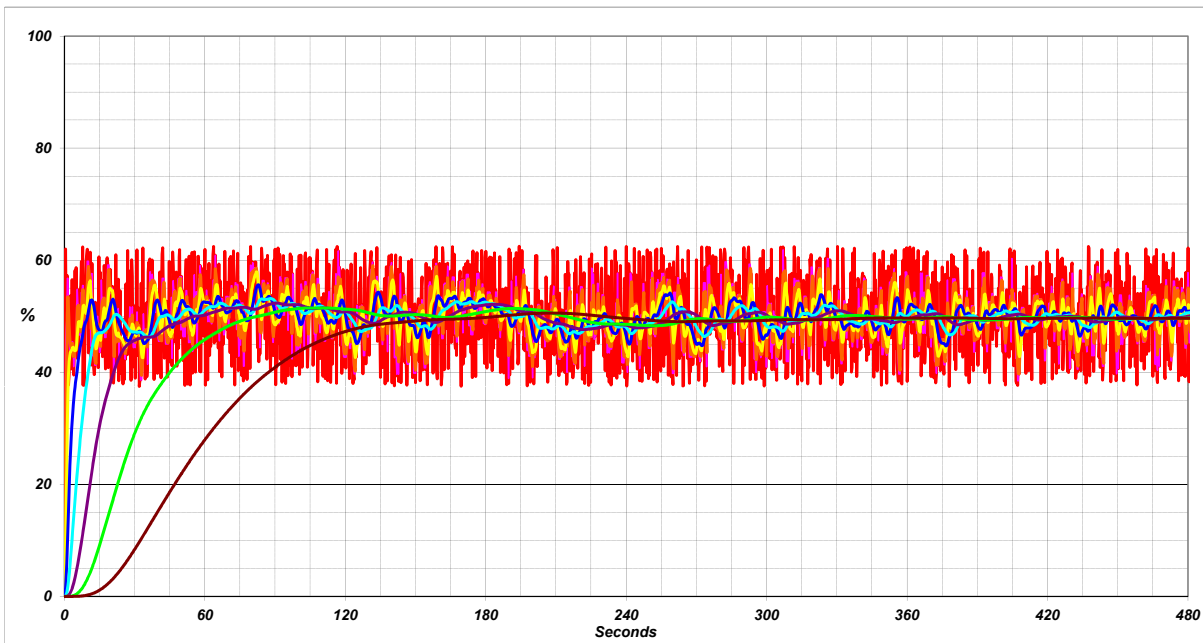

Response to FlexStat Reset and Rapid Random Signal Noise

NOTE: The vertical scale on the left represents 0–100% of the full scale of the input. The bottom scale is time in seconds. Lines representing outputs are:

- Analog-to-Digital Converter chip (ADC) in **RED**
- Median Filter in **PINK**
- IIR Filter with Filter Weight 1 in **ORANGE**
- IIR Filter with Filter Weight 2 in **YELLOW**
- IIR Filter with Filter Weight 3 in **BLUE**
- IIR Filter with Filter Weight 4 in **CYAN**
- IIR Filter with Filter Weight 5 in **PURPLE**
- IIR Filter with Filter Weight 6 (default) in **GREEN**
- IIR Filter with Filter Weight 7 in **BROWN**

Connecting Outputs

Connect the device under control between the desired output terminal and the related SC (**Switched Common for relays**) or GND (**Ground for analog outputs**) terminal. For each bank of three relays, there is one Switched (relay) Common connection (in place of the GND terminal used with analog outputs).

Do not attach a device that draws current exceeding the FlexStat's output capacity:

- **Maximum output current for individual ANALOG outputs is 20 mA @ 12 VDC (each).**
- **Max. output current is 1 A for individual RELAYS @ 24 VAC/VDC or a total of 1.5 A per bank of 3 relays** (relays 1–3 or 4–6).

For example, KMC REE-3111/3112 relays could be connected to the analog outputs, but **REE-3211/3221/3213 relays would exceed the FlexStat's analog output capacity** (although the REE-3211 can be used with the FlexStat's internal relays).

FlexStat internal relays are NO, SPST (Form "A"). (To emulate binary outputs with the analog outputs, set the output voltage to be either 0 or 12 VDC in Control Basic.)

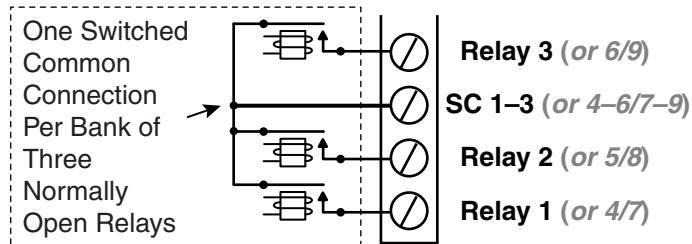

Switched (Relay) Common and Relays

⚠ CAUTION

Relays are for Class-2 voltages (24 VAC) only. Do not connect line voltage to the relays!

⚠ CAUTION

Do not mistakenly connect 24 VAC to an analog output ground. This is not the same as a relay's switched common. See the backplate's terminal label for the correct terminal.

Configuration Screens

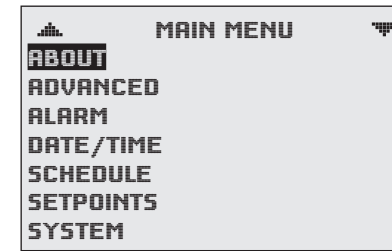



Navigate the menus and change settings by pressing a combination of buttons. Press the:

- *Enter* button to select and/or exit value editing.
- *Up/Down* button to move among **entries** (up/down lines).
- *Left/Right* button to move among **value fields** (left/right spaces).
- *Left* button to return to the Home screen.

NOTE: A log-in may be required to access menu items.

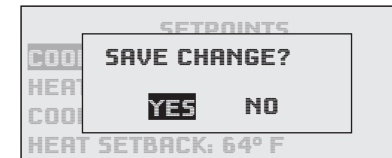
When prompted about a change (on any menu), press *Right/Left* to select the desired choice and then *Enter*.



NOTE: If   appear at the top of the screen (such as in the Main Menu), scroll up or down to see the rest of the menu's off-screen choices.

See the [FlexStat Operation Guide](#) for more configuration and operation details.

Custom Programming

NOTE: Be sure to CAREFULLY READ ALL of the following Custom Programming sections before attempting to custom program a FlexStat!

NOTE: Customized programs are the responsibility of the user. KMC Controls does not provide support for such programs.

NOTE: For additional custom applications not covered in these sections, see KMC's Digital Designer's Guide (SP-022) and adapt programs for other controllers for use in the FlexStat.

General

The FlexStat has a library of built-in applications and options that are configured through the FlexStat's context-sensitive display. Beyond these standard configurations, the following are samples of custom changes that can be added to a FlexStat using **BACstage (ver. 2.4.0.26 or later)** or **TotalControl (ver. 2.0.5 or later)**. (The information in this section assumes familiarity with those software packages—for additional instructions on BACstage or TotalControl, see the respective Help system.)

The FlexStat uses **Next Generation Control Basic** (see the TotalControl or BACstage Help system for more information).

NOTE: If the custom program should automatically run after a restart, Auto-Run should be set to True in the FlexStat menu or from BACstage or TotalControl. See also the **Resetting the FlexStat** section in the **FlexStat Operation Guide!**

CB Programs	PROGRAM #1
PROG1: RUNNING	SETPOINTS & MODES
PROG2: RUNNING	AUTO-RUN: TRUE
PROG3: RUNNING	CHANGE: READY
PROG4: RUNNING	STATE: RUNNING
PROG5: RUNNING	HALT REASON: NORMAL
PROG6: HALTED	HALT DESC:
PROG7: IDLE	OUT OF SERVICE: FALSE

Viewing the Control Basic Programs

FlexStat (read-only) programs 1 through 5 contain Control Basic code for:

- Program 1: Setpoints and Modes
- Program 2: Fan Control
- Program 3: Valve and Staging Control
- Program 4: Damper Control
- Program 5: Safeties

Sample code in the five programs can be viewed in the **Control Basic Programs Reference** document available on the KMC web site. Because of firmware upgrades and differences between models, the programming in any particular FlexStat may be different from the programming shown in that document!

To examine the code in a particular FlexStat, copy the code and paste it into a text editor or print it. In BACstage, print by selecting the printer icon, which automatically prints to the default printer. TotalControl prints from the File menu.

Use the search function to find all terms of interest.

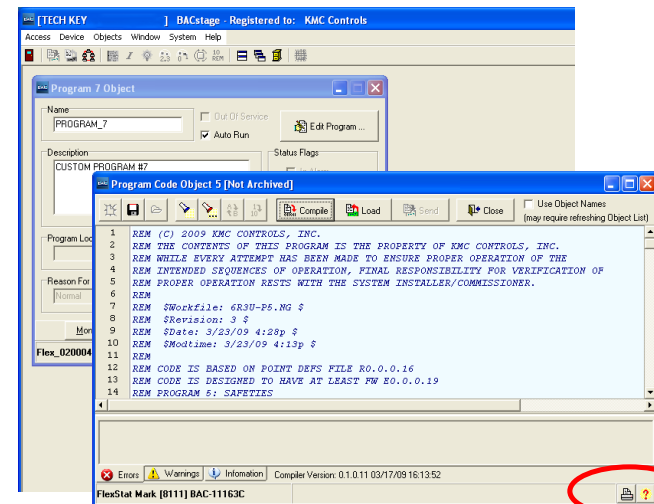

NOTE: Customized programs are the responsibility of the user. KMC Controls does not provide support for such programs.

Modifying the Standard Control Basic Programs

Programs 1 through 5 and 6 through 10

Control Basic programs 1 through 5 are used for built-in applications and can NOT be modified directly. Programs 6 through 10 are empty and can be used for additional programming. Using BACstage or TotalControl, a program (1 through 5) can be copied, pasted into a new program code object (6 through 10), edited, and run in place of the original. (Although programs 1–5 cannot be edited, they can be halted and set to not autorun after restart.)

Because programs are executed sequentially, if a program is copied and modified, ALL of the following programs must also be copied (even if they are not modified)! For example, if program 2 is copied into program 6 and modified, then programs 3 through 5 (even if they contain no modifications) must also be copied into programs 7 through 9. Then programs 2 through 5 are set to NOT autorun, programs 6 through 9 are set to autorun, and the FlexStat is restarted.

Program 1 Common Code and the User Interface

Program 1 interacts with the user interface (display and menus). If Program 1 is copied and replaced, ensure that the common code (up to the application branch code section) in Program 1 is running. Failure to do so may disable one or more user interface functions.

In all models, the common code ends at nearly the bottom of the entire code and is before the application lines (as relevant to the model): AHU_CODE, FCU_2_PIPE_CODE, etc.

In firmware **R1.3.0.8 and after**, the branch code section is somewhere around line 518 to 578 in BAC-1xxx63/1xx63, line 522 to 605 in BAC-1xxx36/1xx36, or line 370 to 496 in BAC-1xx30 and comes after:

```
END_COMMON_CODE :  
END
```

Searching for “COMMON” will quickly find the line. Earlier firmware versions do not have this convenient flag.

In BAC-1xx63, firmware **R1.3.0.4 and earlier**, the branch code section is somewhere around line 457 and looks similar to:

```
REM PERFORM APPROPRIATE SECTION OF CODE BASED ON  
FLEXSTAT CONFIGURATION
```

```
IF APP_MAIN_TYPE = AHU THEN  
    GOTO AHU_CODE  
ELSE IF APP_MAIN_TYPE = RTU THEN  
    GOTO RTU_CODE  
ELSE IF APP_MAIN_TYPE = FCU THEN  
    IF APP_SUB_TYPE = PIPE2 THEN GOTO FCU_2_PIPE_CODE  
    IF APP_SUB_TYPE = PIPE4 THEN GOTO FCU_4_PIPE_CODE  
ELSE IF APP_MAIN_TYPE = HP THEN  
    GOTO HP_CODE  
ENDIF
```

In BAC-1xx36 firmware **R1.3.0.4 and earlier**, the branch code section (ending the common code) is somewhere around line 511 and looks similar to:

```
REM PERFORM APPROPRIATE SECTION OF CODE BASED ON  
FLEXSTAT CONFIGURATION  
IF APP_MAIN_TYPE = AHU THEN  
    GOTO AHU_CODE  
ELSE IF APP_MAIN_TYPE = FCU THEN  
    IF APP_SUB_TYPE = PIPE2 THEN GOTO FCU_2_PIPE_CODE  
    IF APP_SUB_TYPE = PIPE4 THEN GOTO FCU_4_PIPE_CODE  
ENDIF  
END
```

In a BAC-1xx30, firmware **R1.3.0.4 and earlier**, because there is nothing specific to applications other than the AHU, there is no branch code section. However, there is the AHU_CODE label.

After the common code, the appropriate application specific section should be copied, modified as necessary, and running as well.

NOTE: Customized programs are the responsibility of the user. KMC Controls does not provide support for such programs.

Custom Objects Restrictions/Recommendations

The following objects have predefined functions in the firmware and Control Basic. Do not attempt to reuse them for other purposes.

- Analog Values (AV) 1–78 (KMC recommends reserving 1–80)
- Binary Values (BV) 1–40 (KMC recommends reserving 1–50)
- Multi State Values (MSV) 1–15 (KMC recommends reserving 1–20)
- PID Loops (LOOP) 1–6
- Control Basic Programs (PRG) 1–5
- Trend Logs (TL) 1–3
- Event Enrollments (EE) 1–5
- Notification Class (NC) 1

As a best practice when custom programming with new objects, **start with the highest numbered available object** (e.g., AV150) and work down (AV149, AV148, AV147, etc.) as you use them.

NOTE: This object list may be expanded in future releases of firmware.

NOTE: **To see a list of objects and their usage in various applications, download and install the KMC Standard Applications package from the KMC web site and look at the relevant BAC-1xxx Point Definitions file.**

NOTE: See also [Viewing the Control Basic Programs on page 14](#).

NOTE: **Customized programs are the responsibility of the user.** KMC Controls does not provide support for such programs.

Programs During Upgrades and Factory Restores

NOTE: If **custom** Control Basic programs are installed and a **restore to factory settings is performed, all factory programs are restarted but all custom Control Basic programs are halted.** Change the state of each program by loading/running the program from the CB Programs menu (or BACstage).

NOTE: If **custom** Control Basic programs are installed **and set to autorun, whenever the firmware is updated, ALL (factory and custom) programs are halted.**

If **custom** Control Basic programs are installed **but NOT set to autorun, whenever the firmware is updated, factory programs are restarted but any (manual) running custom programs are halted at restart.**

Change the state of each custom program by using the Update Manager or loading/running each program from the CB Programs menu (or BACstage).

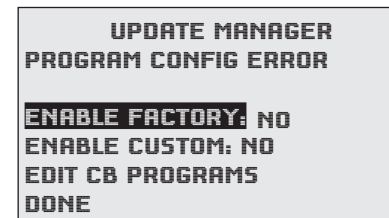

Sample Custom Applications

Adding a Remote Temperature Sensor to an Input

For space temperature, the FlexStat uses an internal sensor tied to Analog Input #1. However, a thermistor can also be connected to one of the extra inputs (2 through 4 and 7 through 9) as a remote room temperature sensor. (Not all applications may have extra inputs available—see the Sample Application sections.)

In the **BAC-12xxxx/13xxxx/14xxxx** FlexStats with **six external** inputs, the Input 7 sensor (AI7) can be configured for a remote space temperature sensor through the menus. Then space temperature can be configured for onboard (internal AI1), remote (AI7), averaging of the two, the lowest reading, or the highest reading.

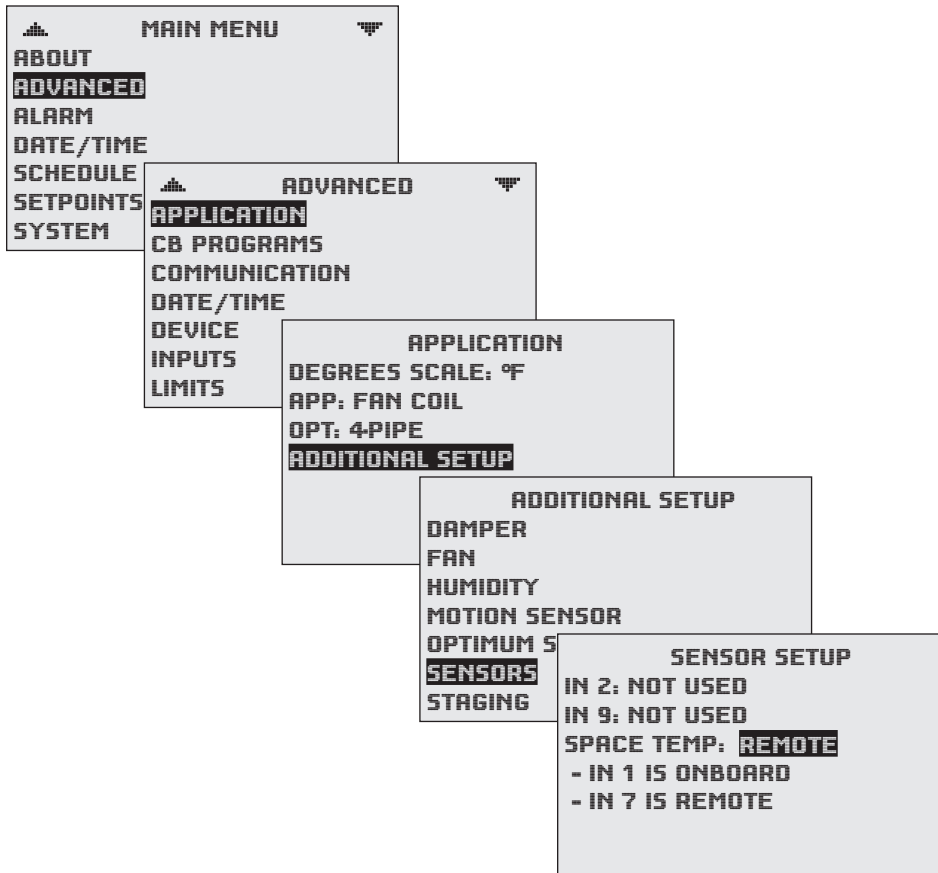

In **BAC-1xxxx** FlexStats with only **three external** inputs, to have the remote sensor's value shown on the FlexStat display instead of the internal sensor's, do the following in BACstage or TotalControl:

1. Configure the original space temperature AI1 object to "Out Of Service."
2. Configure the input for the added room temperature sensor input. (Type III is the default thermistor type for AI2–AI4 and AI7–AI9.)
3. Add the following Control Basic program. (In this example, the application has input #2 open—use another input instead as needed.)
 $AI1 = AI2$
4. Restart the FlexStat.

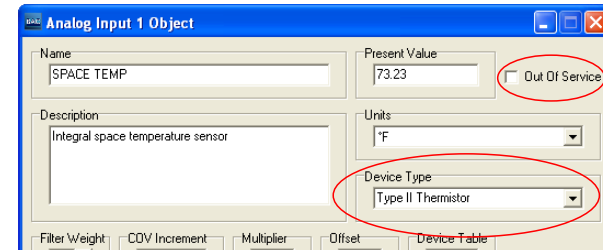

To use a **temperature sensor connected to another controller**, see [Using Sensors Connected to Other Controllers on page 20](#) and use additional code to map the remote sensor's present value to AI2 (or other appropriate input).

It may take a minute before the remote temperature starts displaying correctly. To calibrate the sensor, see [Calibrating a \(Temperature\) Sensor on page 7](#) and use the appropriate input.

NOTE: The Home screen can display temperatures from -99 to 999 (with firmware version R1.3.0.8 or later). Temperatures between -9.9 and 99.9 degrees can be (if enabled in the User Interface menu) displayed with tenths of a degree.

Displaying the Current Setpoint

Method 1

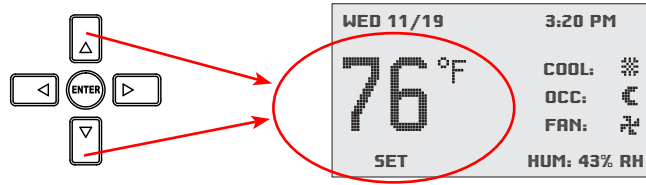

From the Home (temperature display) screen, press the Up or Down arrow button ONCE to view the current setpoint. (Pressing it more than once will change the setpoint and start the override mode.) The setpoint will display for approximately ten seconds.

Method 2

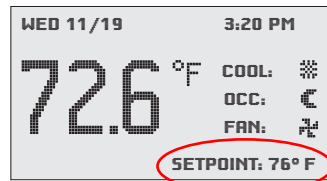

At the lower right of the Home screen is a field that can potentially display several object Present Values. To permanently display the setpoint in this field, use BACstage or TotalControl to do the following:

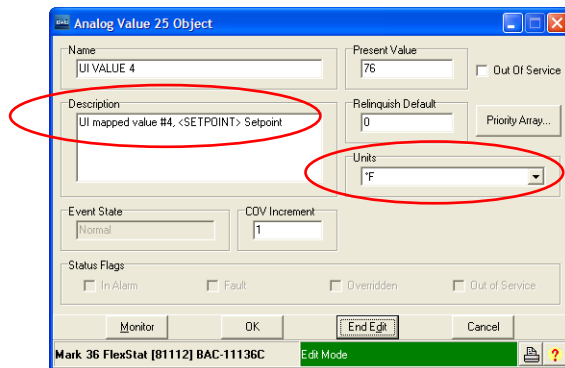

1. Change AV25 Description to “UI mapped value #4, <SETPOINT> Current Setpoint” and configure units for ° F (or ° C as needed).
2. Write the following Control Basic program to assign the current

setpoint present value (AV27) to AV25 and configure it to auto-run:
AV25 = AV27

3. Restart the FlexStat.

NOTE: If several readings (objects) are configured to show in the field, the field will sequentially show each one. For models with humidity sensors (which display **HUM: xx%**), changing AV22’s description to “UI mapped value #1, <HUMIDITY> space humidity” will make the length and spacing of the alternating setpoint and humidity objects display more consistently.

Method 3

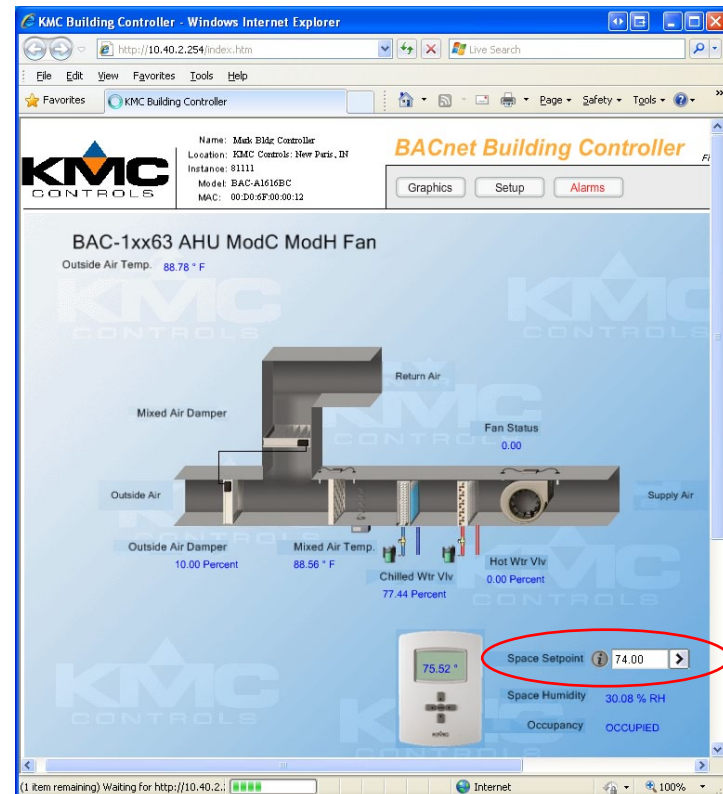

When creating web graphics pages in TotalControl or BACstage, AV27 (the current setpoint) can be monitored and altered from a web page. See [Custom Web Graphics on page 24](#).

See also [Displaying Outside Air Temperature on page 19](#) and [Displaying Other Objects on page 19](#).

Displaying Outside Air Temperature

At the bottom right of the Home screen is an area that can display several object Present Values. In models with the built-in space relative humidity sensor, the relative humidity is automatically displayed. The outside air temperature sensor can also be displayed (assuming a sensor is attached to Input #4 in AHU and RTU applications). **Firmware R2.0.0.9 and later makes it easy to show and hide relevant rotation values from the Advanced > User Interface > Rotation Values menu.** See the [FlexStat Operation Guide](#) for more information

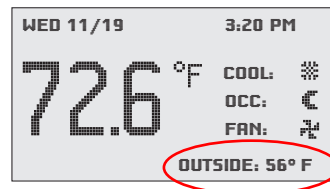

To display the outside air temperature in older firmware, use BACstage or TotalControl to do the following:

1. Open up Analog Value object AV23. The default description is “UI mapped value #2, <~OAT> outside air temp.”
2. Edit the object description by removing the ~ in front of OAT (and optionally changing OAT to OUTSIDE).
3. Restart the FlexStat.

NOTE: If several readings (objects) are configured to show in the field, the values will rotate about every five seconds.

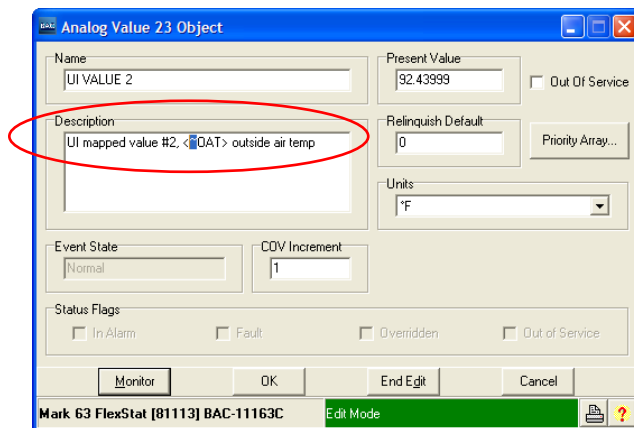

NOTE: For more information about outside air temperature applications, see Application Note AN0410A Measuring Outside Air Temperature on the KMC web site.

Displaying Other Objects

To display another object (not part of the Rotation Values menu) on the bottom right of the screen, modify Analog Value AV25 and write a value to the object in Control Basic. For example, to display the **Mixed Air Temperature** in the economizer (assuming a sensor is attached to Input #3 in AHU and RTU applications), use BACstage or TotalControl to do the following:

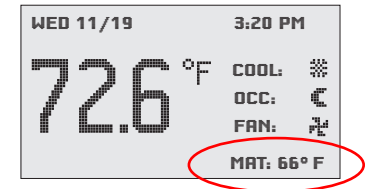

1. Change AV25 Description from “UI mapped value #4, <~UI4> not used” to “UI mapped value #4, <MAT> Mixed Air Temp” and configure units for ° F (or ° C as needed).

NOTE: Put no more than 8 characters between the brackets. (MAT works, but Mixed Air Temp is too long.) Using all capital letters may look better on the LCD screen than mixed case.

2. Write the following Control Basic program to assign the Mixed Air Temperature sensor (AI3) present value to AV25 and configure it to auto-run:

```
AV25 = AI3
```

3. Restart the FlexStat.

NOTE: If several readings (objects) are configured to show in the field, the values will rotate about every five seconds.

NOTE: To hide a display object, add the ~ before the description in the < > in the appropriate Analog Value object or select Hide in the Advanced > User Interface > Rotation Values menu of Firmware R2.0.0.9 or later.

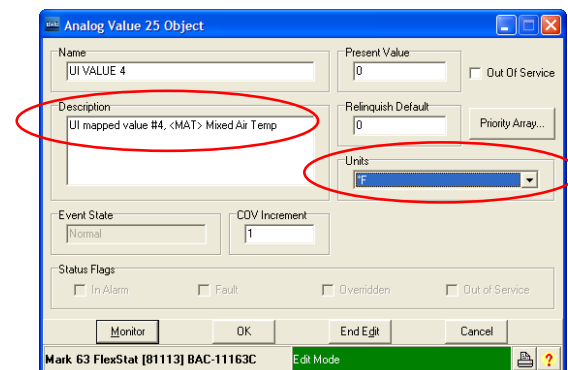

Mapping Analog Inputs or Outputs as Binary

The analog inputs can be mapped as binary values in Control Basic (using BACstage or TotalControl). Set an analog voltage less than 0.5 VDC to equal a binary Off state and an analog voltage of 0.5 to 12 VDC to equal a binary On state.

Some sample lines in Control Basic would be:

```
IF AI2 < 0.5 THEN BV1 = 0 ELSE BV1 = 1
```

OR

```
IF AI2 < 0.5 THEN START BV1 ELSE STOP BV1
```

To emulate binary outputs with the analog outputs, set the output voltage to be either 0 or 12 VDC, such as in:

```
IF BV3 THEN AO7 = 12 ELSE AO7 = 0
```

Motion Sensor Applications

To turn occupancy on (or retrigger) for a set time after the **LAST** motion detection (during a scheduled “off” time), see [Customizing the Motion Sensor and Override on page 30](#). Unlike this custom program, the **built-in** program (for FlexStat models with motion sensors) turns occupancy on for a set time after the **FIRST** detection (during a scheduled “off” time). The built-in program is “non-retriggering.”

To turn occupancy override on from **remote** motion sensors, see [Adding Remote Motion Sensors on page 32](#). This program will work with a built-in motion sensor enabled or disabled. It will also work with FlexStat models that have no built-in motion sensor.

Using Sensors Connected to Other Controllers

The FlexStat can use sensors connected to remote controllers on the same network. For example, an outside air temperature sensor is wired to AI3 of a different networked controller with Device Instance 2010. This program polls the outside air temperature every minute and assigns the value to AI4.

1. Configure the original outside air temperature object AI4 to “Out Of Service” in BACstage or TotalControl.
2. Add **either one** of the following Control Basic program and configure it to auto-run:

Code Example #1

```
IF INTERVAL( 0:01:00 ) THEN AI4 = 2010.AI3
```

Code Example #2

```
ALIAS( 2010, AI3, PV, OutsideAirTemp, 0:01:00,  
      NONE )
```

```
AI4 = OutsideAirTemp
```

3. Restart the FlexStat.

NOTE: Alias is a command used with the FlexStat, Building Controller and all new Next Generation KMC BACnet controllers. See the Help system in TotalControl or BACstage for more information.

NOTE: **Customized programs are the responsibility of the user.** KMC Controls does not provide support for such programs.

NOTE: For additional custom applications not covered in this section, see KMC’s Digital Designer’s Guide (SP-022) and adapt programs for other controllers for use in the FlexStat.

CO₂ Sensors and DCV

“Standard”
BAC-1xxxx or
BAC-12xxxx
FlexStat
without CO₂
Sensor



BAC-13xxxx
and BAC-14xxxx
FlexStat with
CO₂ Sensor



Principles of Operation

NOTE: See the [FlexStat Operation Guide](#) for more information about **configuration and use of DCV** as well as other energy-saving features such as occupancy standby (with the motion sensor). See also the **sequences of operation** starting with **DCV (Demand Controlled Ventilation) – General Information on page 42**. See also the relevant installation guide for the FlexStat or sensor.

Too little ventilation may make us feel lethargic and cause us to breathe in pollutants (e.g., VOCs, radon, cigarette smoke) that accumulate in inside air and are potentially hazardous to our health. Too much ventilation, on the other hand, is fine for people but wastes energy in conditioning the extra, unnecessary outside air. HVAC systems in many commercial buildings are designed for a specific number of occupants, but typical occupation levels at any given time are usually lower than these “worst case” design levels. Hence, such building spaces receive more ventilation than necessary and energy is wasted. Just the right amount of ventilation is the ideal, sustainable balance between protecting indoor air quality and health of occupants versus minimizing energy costs.

The most effective means of attaining a “Goldilocks” zone for ventilation is by using CO₂ sensors and **demand control ventilation (DCV)** sequences in a Building Automation System. (DCV is also sometimes called demand controlled ventilation.) DCV adjusts the amount of outside air ventilation to keep CO₂ levels measured by inside sensors at or below a specified maximum (usually 700 ppm of CO₂ above that of outside air, which is typically around 400 ppm). Instead of controlling

the ventilation based on preset worst-case scenarios, DCV continuously controls ventilation based on real-time actual needs. This produces substantial energy and cost savings...especially for facilities with highly variable occupancy, such as meeting rooms, classrooms, theaters, gyms, retail stores, and hotels.

With a built-in CO₂ sensor, the BAC-13xxxx series FlexStat uses patented self-calibration techniques designed to be used in applications where concentrations will drop to outside ambient conditions (approximately 400 ppm) at least three times in a 14 day period, typically during unoccupied periods. (This series has been certified to comply with CA Title 24, Section 121(c), as well as sub-paragraph 4.F that specifies accuracy will be maintained within tolerance for a minimum of 5 years without recalibration.)

However, in zones that may contain people 24/7, the inside CO₂ levels will not drop to outside levels consistently. For zones with continuous occupancy, the BAC-14xxxx series has a dual channel sensor. In that sensor, a CO₂ channel measures gas concentration, and a reference channel measures the sensor signal intensity. Self-calibrations are performed approximately every 24 hours using the reference channel.

Although BAC-12xxxx FlexStats do not have a built-in CO₂ sensor, they still have DCV control sequences available. When DCV is enabled in the Damper Setup menu of these models, **IN9** is assumed to be connected to an external SAE-10xx CO₂ (duct or space) sensor. **0–5 VDC on that input will map to 0–2000 ppm (using the defaults). The output of the connected SAE-10xx must also be configured to match the FlexStat’s input, and the FlexStat’s IN9 pull-up resistor must be set for 0–12 VDC!**

BAC-13xxxx/14xxxx FlexStats also have the external sensor option, and if used, the **highest** of the two readings (internal vs. external) will be used to control DCV sequences. The CO₂ ppm display (if enabled) also shows the highest of the two levels.

CO₂ Sensor Calibration

The BAC-13xxxx models (with T6613 model sensors) do **not** have a calibration with gas option. It uses Automatic Background Logic, or ABC Logic™, a patented self-calibration technique designed to be used **in applications where concentrations will drop to outside ambient conditions (approximately 400 ppm) at least three times in a 14 day period**, typically during unoccupied periods. With ABC Logic enabled, the sensor will typically reach its operational accuracy after 25 hours of continuous operation if it was exposed to ambient reference levels of air at 400 ±10 ppm CO₂. The sensor will maintain accuracy specifications with ABC Logic enabled, given that it is at least four times in 21 days exposed to the reference value and this reference value is the lowest concentration to which the sensor is exposed. ABC Logic requires continuous operation of the sensor for periods of at least 24 hours.

The BAC-14xxxx models (with T6615 model sensors) have a **calibration option for applying gas to the sensor** for maintaining maximum accuracy. The BAC-14xxxx has a dual channel sensor (a CO₂ channel measures gas concentration, and a reference channel measures the sensor signal intensity). Self-calibrations are performed approximately every 24 hours using the reference channel. During the self-calibration the sensor PPM reading is frozen and will not react to changing CO₂.

If the unit has been field-calibrated since leaving the factory, information about the last calibration (date, elevation, and ppm of reference gas) will be displayed in the lower part of the screen.

Calibration should be done in an area with stable space temperature. There should be no significant air drafts or temperature variations during the calibration procedure.

To calibrate the BAC-14xxxx models, a KMC HTO-1103 and a GE Telaire 2075 (or equivalent) kit and gas are required:

1. Follow the instructions in the **GE Telaire 2075 (or equivalent) calibration kit** and gas, available locally or from vendors such as instrumart.com, testequipmentdepot.com, grainger.com, calibration-gas.com, and/or buycalgas.com) for attaching a regulator and tube to a cylinder of reference gas.
2. On the FlexStat, turn the hex screws in the bottom and top **clockwise** until they clear the cover.
3. Carefully pull the cover away from the backplate (mounting base).
4. Attach the **adapter plate (with attached power cable) for the BAC-13xxxx/14xxxx FlexStat** from the **HTO-1103 FlexStat Firmware Upgrade Kit** to the back of the cover. (See the **HTO-1103 Installation Guide** for more information.)
5. Remove the protective rubber cap from the power adaptor cable's two pins and insert the pins into the 24 VAC power section (Com and ~ on lower right) of the wall-mounted terminal blocks. (Keep the cap on the pins when not in use.) Allow the unit to warm up for several minutes before proceeding.
6. Remove the protective caps from both of the calibration tube fittings on the back of the FlexStat board.

NOTE: Although the caps are not required for maintaining the accuracy of the sensor, they protect against insects, dust, or other contaminants from getting inside the tubes. If a cap is lost, the sensor will still function normally, but the cap should still be replaced as soon as is feasible.

7. Connect the tubing from the reference gas cylinder to either of the FlexStat calibration tube fittings using the 3.5"-long adapter tubing (201-403-03) from the HTO-1103 FlexStat Firmware Flash Upgrade Kit. One end of the adapter tubing fits **over** one of the FlexStat calibration tube fittings. The other end fits **inside** the standard 1/4" OD tubing that comes from the regulator.

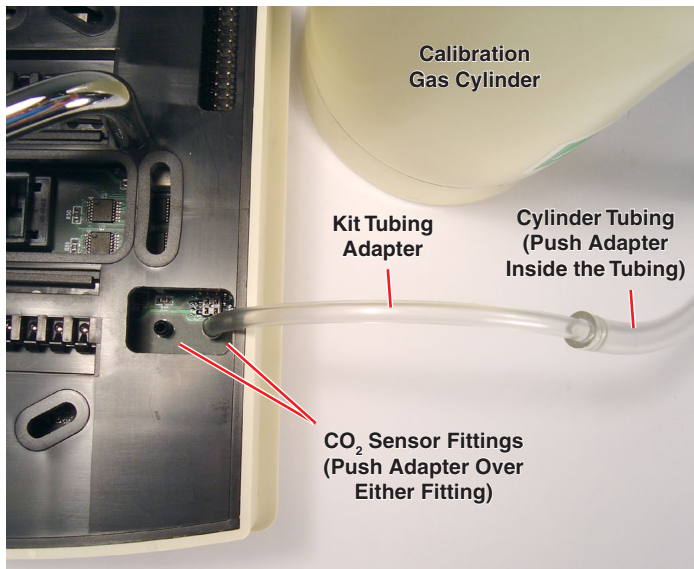

NOTE: It may be easier to attach the adapter tubing to the fitting **before** attaching the backplate to the FlexStat.

NOTE: The programming pod and USB cable in the HTO-1103 kit are **not** used during CO₂ calibration. The BAC-13xxxx/14xxxx backplate adapter in the kit is used for **both** CO₂ calibration and firmware upgrading for those models.

8. Select the Advanced > CO₂ Sensor > Calibration menu.
9. Enter the elevation and ppm of the reference gas used. (Elevation for any particular location can be found at such sources as www.earth-tools.org.)
10. Open the cylinder's regulator to allow 7 psi of gas through the sensor.
11. Change Mode from Monitor to Calibrate and push Enter. The Calibration Time will begin counting at the bottom of the screen.

NOTE: After initiating, the calibration process takes approximately 4 minutes and cannot be stopped by any button presses until the cycle is complete. If power is removed before the calibration process is completed, the old values will be retained.

NOTE: No matter what the normal inactivity time-out setting is (in Advanced > User Interface menu), time-out for the calibration screen is 10 minutes.

12. After the calibration process is complete, Mode will change from Calibrate to Monitor. Press the *Left* button and information about the most recent calibration (date, elevation, and ppm of reference gas) will be displayed in the lower part of the screen.
13. Turn off the gas, remove the connected tubing, and reinstall the protective caps in the calibration tubes.
14. Carefully remove the adapter plate and power cable and reinstall the FlexStat on its backplate **while being careful not to pinch or dislodge any wiring**.
15. Back the hex screws (counterclockwise) out of the brackets until they engage the FlexStat cover and hold it in place.

Custom Web Graphics

When creating web graphics pages in TotalControl or BACstage, the following objects are the most commonly used.

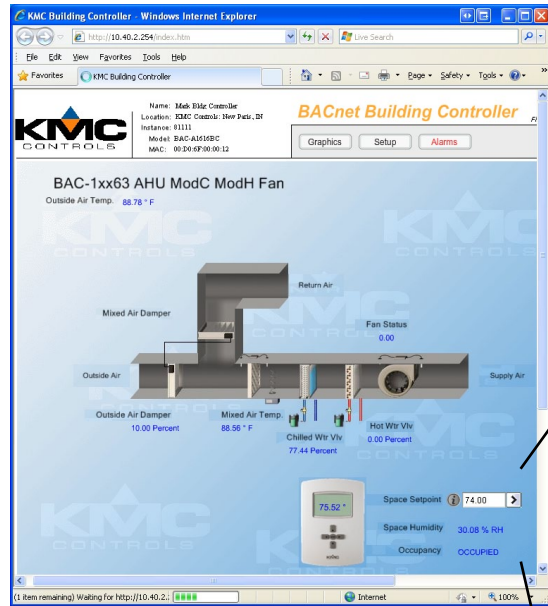

NOTE: For FlexStat application graphic templates to use in TotalControl (as shown above), download KMC's Library of Standard Applications package from the KMC web site. For FlexStat device images, download the FlexStat Device Drawings and Images collection.

NOTE: For information about creating a graphical web page interface, see the Help systems in TotalControl or BACstage.

NOTE: See also the Alarms and (Advanced) Trend Logs sections in the [FlexStat Operation Guide](#) for more objects.

Room Setpoint and Override

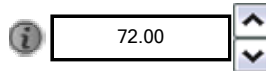

UI SETPT (AV27):
Use this to temporarily change space temp. setpoint for the duration of the override timer (AV16). *(9)

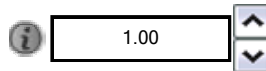

OVERRIDE TIME (AV16):
If set to 0, override will last until the next schedule event. *(8)

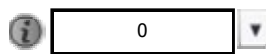

SETPT OVERRIDE MODE (BV2):
Use this to remove override or view if schedule setpoints are overridden. *(9)



SPACE TEMP (AI1/AV40)
SPACE HUMIDITY (AI5/AV22)
SPACE CO2 (AI10/AV78)
OAT (AI4/AV23)

Schedule Setpoints

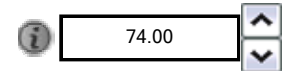

OCC COOLING SETPT (AV20) *(8)

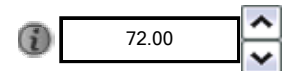

OCC HEATING SETPT (AV21) *(8)

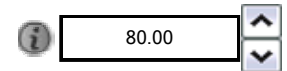

UNOCC COOLING SETPT (AV4) *(8)

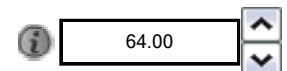

UNOCC HEATING SETPT (AV5) *(8)

*(8) = Writing at priority level 8 will synchronize with the user interface (neither locks the other out).
*(9) = Writing (AV27 and BV2) at priority level 9 will synchronize with user interface programs.

Hospitality and Locked User Interface Modes

Selecting UI Modes

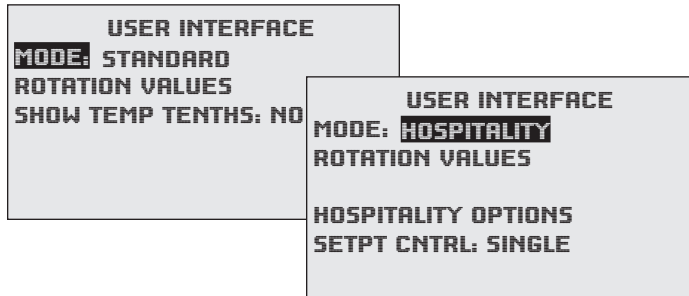

Advanced > User Interface toggles the home screen and other menus between the default Standard mode and other (more restricted) modes.

NOTE: COMPLETE ALL OTHER NECESSARY CONFIGURATION BEFORE SELECTING HOSPITALITY OR LOCKED UI MODE! After Hospitality or Locked UI mode is selected, it is intentionally difficult to revert to Standard mode!

NOTE: As additional security against unauthorized bypass of Hospitality or Locked UI mode from the FlexStat, set at least an Operator level password. (See the [FlexStat Operation Guide](#).)

Locked UI mode (also known as Mode 3) on the Home screen, but all **button** functions (except the backlight) are **locked**.

Hospitality mode (also known as Mode 2) has limited menus and is typically used in hotel rooms. Users typically can change only the setpoint, system mode, and fan speed. Pushing the *Left* and *Right* buttons displays **customizable menu selections** (dependent on the configuration), such as **System** (Auto, Heat, Cool, and Off) and **Fan** (Auto, High, Medium). (See the [FlexStat Operation Guide](#) about Single Setpoint vs. Schedule options.)

NOTE: Menus depend on the configured options. A three-speed fan will display Auto, Low, Medium, and High, but a one-speed fan will only display Auto and On.

NOTE: Auto in System Mode does not currently have an icon implemented with it. Manually selecting Heat or Cool will display an icon on the Home screen.

NOTE: If this new feature does not work (is “Inactive”) after upgrading the firmware (especially from R1.3.0.4 or earlier), you may need to restore the factory default (especially if there is custom programming or configuration in the FlexStat) and reconfigure the FlexStat. See the [FlexStat Operation Guide](#) for information.

(Hospitality Mode Sample Screens)

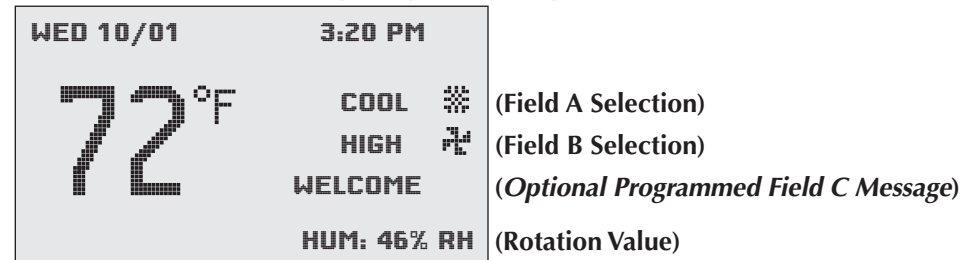

Pushing *Enter* Button Toggles °F/°C Temperature Scale

Pushing *Left* Button Goes to Field A Screen

(Pushing *Right* Button Goes to Field B Screen)

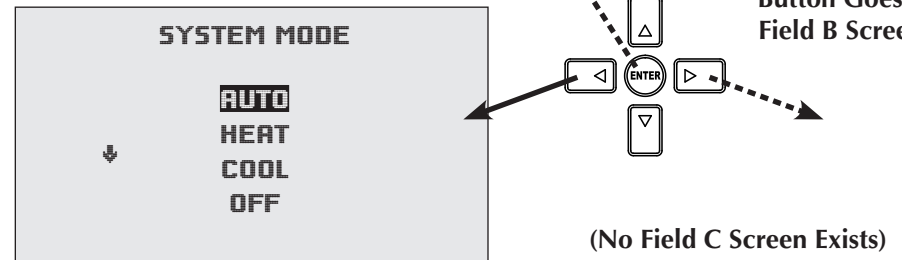

Custom Hospitality mode programming is required for:

- Use of **Field C** for displaying messages.
- Creating additional/alternate menu options.
- Any use of AHU or RTU applications in firmware **R1.3.0.11**. (Firmware earlier than R1.3.0.11 did not support Hospitality mode at all, and R1.3.0.11 natively supported only FCU or HPU applications in Hospitality mode. The latest firmware supports all the applications.)

See [Programming Custom Text for Hospitality Mode on page 28](#) and [Custom Programming on page 14](#).

Reverting UI Modes

Via the User Interface

Reverting to Standard mode can be done through the FlexStat's user interface with a combination of button presses or by changing MSV9's values through BACstage or TotalControl. **To revert to Standard mode through the user interface**, follow these steps to access the hidden menus:

1. Press and hold both the *Enter* and *Right* buttons for at least five seconds. (If you push the *Right* button before *Enter* while in Hospitality mode, you will go to the Field B screen.)
2. While continuing to hold those two buttons, press the *Left* button and hold all three buttons for at least five seconds.
3. Release the *Right* button but continue holding the *Left* and *Enter* buttons until the FlexStat menu appears (after about five more seconds).

NOTE: While holding the *Left*, *Right*, and/or *Enter* buttons, do not accidentally also hold the *Up* or *Down* button.

NOTE: The FlexStat menu has **view-only** About, Date, and Time lines. The About selection contains the same information as the About screen in the Standard mode's Main Menu. The Date and Time lines simply display the current date and time information.

4. To access and make changes in the "hidden" Main Menu, use the *Up/Down* buttons to navigate to the **SECOND** blank line below the Time line and press the *Enter* button.

NOTE: Access to this hidden menu is password protected (if both the Operator and Administrator passwords are not 0000). Entering either an Operator or Administrator level password accesses the Main menu (a User password will not work).

5. The menus operate as normal from this point. **To return to Standard mode, navigate to the Advanced > User Interface menu and select Standard (otherwise, the previously selected mode will continue).**

Via BACstage or TotalControl

To revert to Standard mode through BACstage or TotalControl:

1. Change the Present Value of MSV9 from 2 (HOSPITALITY in TotalControl) or 3 (LOCKED UI) to 1 (STANDARD).

NOTE: When the FlexStat is restarted, however, MSV9's Present Value will revert to the Relinquished Default and the user interface will revert to the previously selected mode. If a quick configuration change is desired instead of a permanent mode change, this is a helpful tool.

2. To make the change **permanent**, change the Present Value AND the Relinquished Default to the desired value.

NOTE: Do not change the Present Values or Relinquished Defaults of any other MSVs 1–12. Doing so may make the FlexStat malfunction!

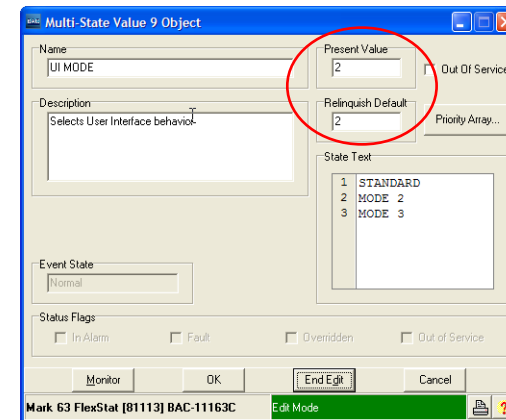

Resetting Hospitality Mode Setpoints to Defaults

Hospitality Setpoint Principles

In Hospitality mode, users have continuing control over single, occupied, and unoccupied setpoints:

- Under the Single Setpoint option, the setpoint will remain at whatever value was last selected by a user until a user adjusts the setpoint again.
- Under the Schedule option, the setpoint values persist even after switching between scheduled occupied and unoccupied periods. For example, if a user changes the occupied cooling setpoint to 76°, the occupied cooling setpoint will remain at 76° on subsequent days until a user adjusts it again.

To automatically reset setpoints to default values at particular times (e.g, daily near midnight):

- A building automation system can overwrite the setpoint value objects. See [Custom Web Graphics on page 24](#) as well as the Control Basic program section below to determine values to control.
- Custom programming can be put into the FlexStat. See the Control Basic program section below and [Custom Programming on page 14](#).

Control Basic Programs

For the **Schedule** option, add an equivalent of the following Control Basic lines:

```
REM Reset Hospitality Mode Setpoints to Schedule
Defaults
IF+ TIME > 23:59:00 THEN GOSUB RESET_SETPOINTS
REM 23:59:00 = 11:59 PM
END
RESET_SETPOINTS :
AV4@8 = 78 : REM UNOCC COOLING SETPT
```

```
AV4.RELINQUISH_DEFAULT = AV4
AV5@8 = 66 : REM UNOCC HEATING SETPT
AV5.RELINQUISH_DEFAULT = AV5
AV20@8 = 74 : REM OCC COOLING SETPT
AV20.RELINQUISH_DEFAULT = AV20
AV21@8 = 70 : REM OCC HEATING SETPT
AV21.RELINQUISH_DEFAULT = AV21
RETURN
```

For the **Single Setpoint** option, use this instead:

```
REM Reset Hospitality Mode Setpoint to Schedule De-
fault
IF+ TIME > 23:59:00 THEN GOSUB RESET_SETPOINT
REM 23:59:00 = 11:59 PM
REM AV27 = UI Setpoint; BV7 = Heat/Cool Mode
END
RESET_SETPOINT :
IF BV7 THEN
    REM COOLING MODE
    AV27@8 = 74
ELSE
    REM HEATING MODE
    AV27@8 = 70
ENDIF
AV27.RELINQUISH_DEFAULT = AV27
RETURN
```

Programming Custom Text for Hospitality Mode

On the Home screen, menu items (“state” text) for Fields A, B, and C appear to the left of the associated icon (if any). The displayed state text is limited to **seven** characters for A and B and **ten** for C.

Hospitality Mode Multi-State Variables		
Function	Variable	Comments
User Interface (UI) Mode	MSV9	(1 = Standard Mode) 2= Hospitality Mode (3 = Locked UI Mode)
Field A (Left Button)	MSV10	Present Value Selects Menu Text (BV28 =1 Animates Icon)
Field B (Right Button)	MSV11	Present Value Selects Menu Text (BV29 =1 Animates Icon)
Field C	MSV12	Present Value Selects Menu Text (BV30 =1 Animates Icon)

NOTE: In TotalControl, to create, edit, or delete any of the state text fields, right-click in the box and select the desired function from the pop-up context-sensitive menu.

NOTE: The state text is automatically centered in its respective field on the home screen display.

Each state text (menu item) of the Field A, B, and C can have an icon associated with the state value. The icon selections are contained within the [] brackets of the MSV Description property. The icon selections (e.g., [H, C, V]) are in the state text order with a comma separator (e.g., the second icon is linked to the second state text). **Icon choices are:**

- **B**, a space, or no character = Blank (no icon, the default)
- **H** = Heat (vertical lines, waving when animated)
- **C** = Cool (snowflake, growing when animated)
- **F** = Fan (four blades, rotating when animated)
- **V** = Vent (horizontal lines, waving when animated)
- **D** = Dehumidification (water drop, evaporating when animated)
- **W** = Humidification (water drop, filling when animated)

Icon animation is controlled by the state of the corresponding BV28, BV29, or BV30 (see chart).

When BV Present Value = 1, Corresponding Icon Animates

The image shows two configuration windows. The top window is for 'Binary Value 28 Object' (BV28) with Name 'UI FIELD A ICON ACTIVE' and Present Value '1'. The bottom window is for 'Multi-State Value 10 Object' (MSV10) with Name 'FIELD A', Description 'UI Field A selections <SYSTEM MODE> [H,C,V]', and State Text '1 HEAT, 2 COOL, 3 VENT, 4 OFF'. Arrows from text labels point to these fields: 'Field A Screen Title' points to the Name field, 'Icons' points to the Description field, 'Current Selection Among Menu Choices' points to the Present Value field, and 'Menu Choices' points to the State Text field.

NOTE: See also the illustration in [Selecting UI Modes on page 25](#).

The title for the Field A and B screens is obtained from the text contained within the angled brackets (e.g., <TITLE>) of the MSV Description property.

Field C is not changeable from the user interface. However, text can be added to the State Text of Field C (MSV12) to provide a desired message (of up to ten characters) on the Home screen. Control Basic could, for example, be used to display “No Disturb” or “Clean Room” according to an external switch position.

After custom text and icons have been configured, restart (cold start) the FlexStat to complete the process!

NOTE: Firmware earlier than R1.3.0.11 did not support Hospitality mode at all, and R1.3.0.11 natively supported only FCU or HPU applications in Hospitality mode. To use Hospitality mode for AHU or RTU applications in R1.3.0.11, a custom Control Basic program must read MSV10 and MSV11 and use those values to control the relevant functions—or simply upgrade to the latest firmware for full functionality. For more information on custom programming, see [Custom Programming on page 14](#).)

Motion/Occupancy Sensor

Performance and Applications

For any FlexStat model with a (passive infrared) motion/occupancy sensor option, **be sure to install it where it will have unobstructed view of the most typical traffic area. Do not install it behind curtains or other obstructions. Do not install it where it will be exposed to sunlight or heat sources! Do not install near a heating/cooling duct.**

For some applications, such as hotel rooms, bedrooms, and other sleeping quarters, **lack of detected motion may not truly mean “unoccupied.”** Motion sensors coupled with door contacts can prevent such undesired setbacks. If no motion is detected during a predetermined time after a door opening/closing is detected, then the mode changes to unoccupied. However, if motion is detected during the timed period after a door has been opened/closed, then occupied mode shall remain on until the next time a door is opened or closed (and the timed period begins again). (Custom programming is required.)

The effective detection range is approximately 10 meters or 33 feet.

Factors that may reduce the range include:

- Too small of a difference in object surface temperature compared to the background temperature.
- Object movement in a direct line toward the sensor.
- Very slow or very fast object movement.
- Obstructions.

False detections may be triggered by:

- The **temperature inside the detection range changing suddenly** because of entry of cold or warm air from an air-conditioning or heating unit.
- The **sensor being directly exposed** to sunlight, an incandescent light, or other source of far infrared rays.
- Small animal movement.

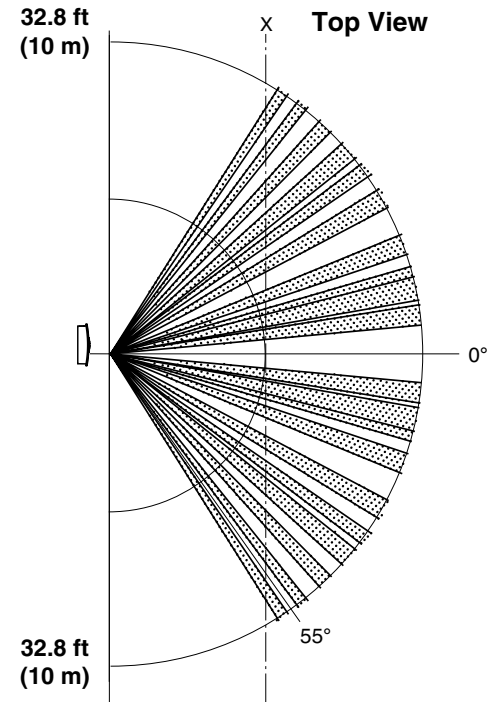

Motion/Occupancy
Sensor
Detection
Performance

NOTE: To maintain maximum sensitivity, occasionally wipe dust or dirt off the lens—but do not use any fluid on the sensor.

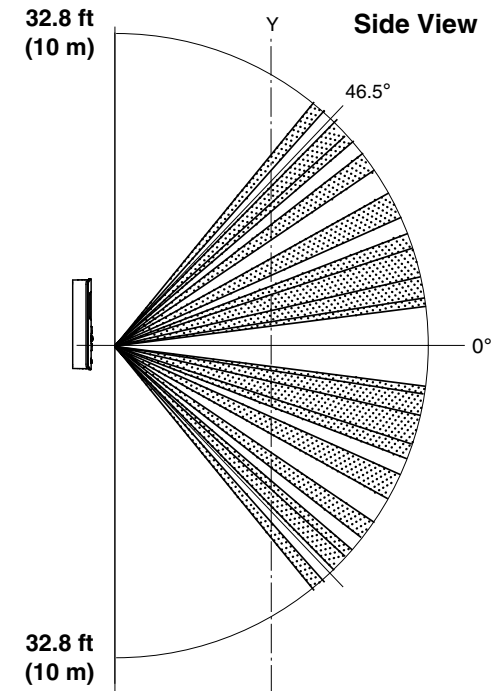

Enabling/Disabling the Sensor and Override Time

In relevant models, the motion sensor may be used to trigger occupancy override. The sensor function is enabled or disabled from the Motion Sensor menu (firmware version R1.2.0.6 and later).

During scheduled “off/unoccupied” times, the motion sensor (when enabled) will start occupancy override (for 1 hour as a default) when it detects motion. Occupancy override will end (with the default setting) 1 hour after motion was **FIRST** detected. (This functions similarly to the override when a setpoint change is detected at the FlexStat’s user interface.) The timer length of occupancy override is configurable in the System menu. For the built-in programs, if this number is set to 0, the override state will last until the next schedule change.

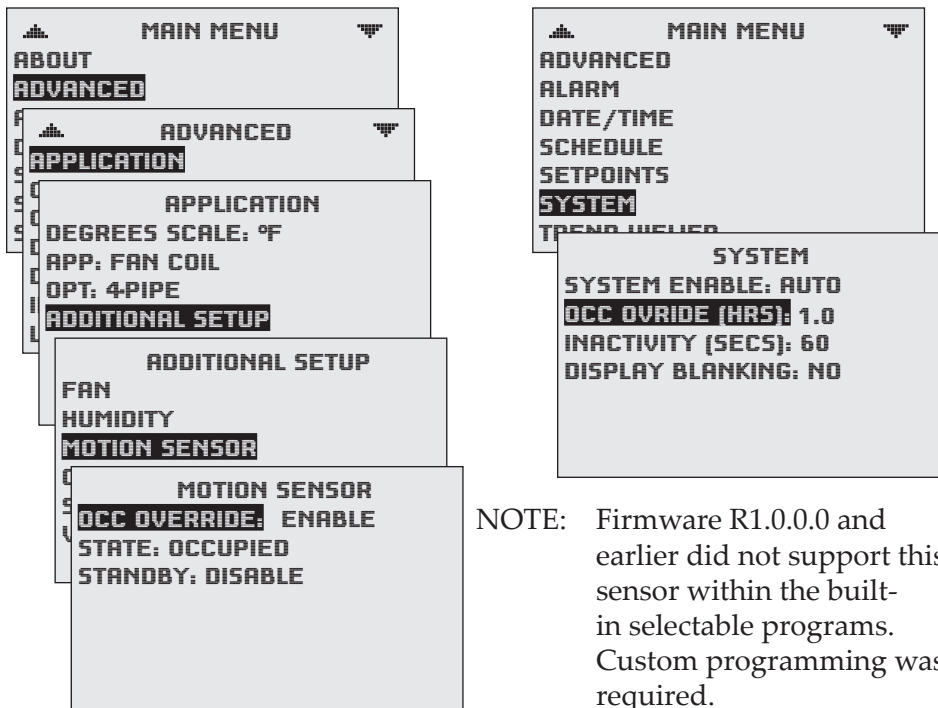

NOTE: Firmware R1.0.0.0 and earlier did not support this sensor within the built-in selectable programs. Custom programming was required.

NOTE: The State field in the Motion Sensor menu monitors whether motion has been detected during the last scan of the motion sensor input (BI6). Detected motion will momentarily show an “occupied” state. This can be used during troubleshooting to determine if motion is being detected.

Customizing the Motion Sensor and Override

When the occupancy sensor function is disabled from the menu, the built-in applications will not use it. Even then, however, the sensor input (BI6) can be read and used in a custom program. An example Control Basic program (for BACstage or TotalControl) that turns occupancy on (or retriggers) for a set time after the **LAST** detection (during a scheduled “off” time) is:

```
REM MOTION SENSOR OCCUPANCY CONTROL OPERATION CODE
ONLY
LOCALS MOTION_SENSOR
LOCALS OVERRIDE_TIMER
OVERRIDE_TIMER = AV16
IF OVERRIDE_TIMER <= 0 THEN
    GOTO SKIP_OCC_CONTROL
ENDIF
IF MODELNUMBER > 11000 THEN
    MOTION_SENSOR = BI6
    IF MOTION_SENSOR THEN
        START BV1@8
    ENDIF
ENDIF
IF TIMEOFF( MOTION_SENSOR ) > ( OVERRIDE_TIMER *
    3600 ) THEN
    RLQ BV1@8
ENDIF
ENDIF
SKIP_OCC_CONTROL:
REM CONTINUE WITH ADDITIONAL CODE
```

NOTE: For this custom program to function, Occupancy Override time in the System menu must **not** be set to 0.

NOTE: Unlike this custom program, the **built-in** program turns occupancy on for a set time after the **FIRST** detection (during a scheduled “off” time). The built-in program is “non-retriggering.”

NOTE: See important information about custom programming in [Custom Programming on page 14](#).

Adding a Door Contact for Additional Control

Limits of Using Motion Sensors Alone

When occupancy is determined by a motion sensor alone in hotel rooms or small offices, lack of observable motion (while a person is sleeping or behind obstructions) will incorrectly place the FlexStat in unoccupied mode. Providing additional control logic via a door switch contact (wired to an available input on the FlexStat) allows the room to remain identified as occupied even though no motion is sensed for some time.

To use a door contact, copy FlexStat Program 1 into Program 6 and put the additional code after the program section that ends:

```
REM WAIT UNTIL VALUE OF BV1 IS DEFINITE TO SET OCC-  
MODE  
OCC_MODE = BV1
```

and before the section that starts:

```
STANDBY :  
REM NO MOTION DURING OCC FOR 30 MINS=STANDBY, IF  
ENABLED
```

(This is around line 372 in firmware R2.x.x.x on a BAC-11163.)

This example assumes a Normally **Open** switch connected to an available analog input (IN2) on the FlexStat. (The relevant input pull-up switches should be set to 10K ohms.) When the door is closed, the switch closes, which shorts the input (voltage across the input is near 0). The analog input is “converted” into a binary input with object name Door_Contact. See [Mapping Analog Inputs or Outputs as Binary on page 20](#).

If a Normally **Closed** switch is used instead, change the < 0.5 to > 0.5 in the code.

The motion sensor is BI6 with object name OCC_SNSR (active state is On), and the Occupied/Unoccupied room status object used to control the HVAC system is BV1 (active state is Occupied).

If motion is detected while the door is closed, occupancy mode is on indefinitely until the door opens. After the door closes again and no motion is detected while the door is closed, the FlexStat will go into unoccupied mode after the System Occupancy Override time expires.

NOTE: If a second occupant is sleeping when the first occupant leaves the room, this code will still assume that the room is empty if the second occupant does not trigger the motion sensor in the allotted time.

NOTE: **Read carefully the important information about custom programming in [Custom Programming on page 14](#)!**

Additional Code

```
REM MOTION SENSOR WITH DOOR CONTACT LOGIC CODE  
REM All schedules must be deleted or set to OFF  
REM Motion Sensor Occupancy Override must be enabled  
and Standby should be disabled  
REM System Occupancy Override time should be reduced  
to 0.5 hours in menu  
REM (Alternately reduce the time to less than 0.5  
hours using BACstage or TotalControl to change  
AV16's present value and relinquish default)  
REM For Hospitality Mode, Hospitality Options > Set-  
point Control must be set to Schedule  
LOCALS DOOR_CONTACT : REM Normally Open switch con-  
tact connected to AI2  
IF AI2 < 0.5 THEN DOOR_CONTACT = 1 ELSE DOOR_CONTACT  
= 0  
IF TIMEON( DOOR_CONTACT ) > 0:00:02 AND OCC_SNSR THEN  
START BV1@7  
REM If any motion is detected while door is closed,  
go to and remain in Occupied Mode (until door  
opens)  
IF NOT DOOR_CONTACT THEN RLQ BV1@7  
REM If door opens, relinquish default of BV1@7 (oc-  
cupancy mode)
```

NOTE: Change AI2 to match the input used as needed.

Menu Configuration

NOTE: All Schedules must be deleted or set to OFF.

NOTE: See the [FlexStat Operation Guide](#) for more information on these menus.

SCHEDULE
ENTIRE WEEK (MON-SUN)
WEEKDAY: ENTIRE WEEK
WEEKEND 1: 12:00:00 AM OFF
INDIVIDUAL 2:
HOLIDAYS 3:
4:
5:
6:
 [->) DELETES ENTRY

MOTION SENSOR
OCC OVERRIDE: ENABLE
STATE: OCCUPIED
STANDBY: DISABLE

NOTE: Motion Sensor Occupancy Override must be enabled and Standby should be disabled.

NOTE: If IN2 or IN9 is used for the input, configure it as "Not Used" in the Sensor Setup menu.

SENSOR SETUP
IN 2: NOT USED
IN 9: NOT USED
SPACE TEMP: ONBOARD
- IN 1 IS ONBOARD

USER INTERFACE
MODE: HOSPITALITY
ROTATION VALUES
SHOW TEMP TENTHS: NO
HOSPITALITY OPTIONS
SETPT CNTRL: SCHEDULE

NOTE: For Hospitality Mode, Setpoint Control must be set to Schedule.

NOTE: System Occupancy Override time should usually be reduced to 0.5 hours in the System menu. Alternately reduce the time to less than 0.5 hours using BACstage or TotalControl to change AV16's present value and relinquish default.

SYSTEM
SYSTEM ENABLE: AUTO
OCC OVRD (HRS): 0.5

Analog Value 16 Object
 Name: OVRD TIMER Present Value: 0.25
 Description: Occupancy Override Time Relinquish Default: 0.25
 Units: Hours
 Event State: Normal COV Increment: 1
 Status Flags: In Alarm, Fault, Overridden, Out of Service
 Buttons: Monitor, OK, End Edit, Cancel

Adding Remote Motion Sensors

Situations that would need remote sensors to be connected to the FlexStat include:

- Areas too large for adequate coverage by the FlexStat's built-in sensor.
- Areas with obstructions that block sensor coverage.
- Use of FlexStat models that do not have a built-in sensor.

Remote motion sensors can be connected to one of the FlexStat's available inputs. (Custom programming is required.) Multiple remote sensors with dry (relay/switch) contacts can be wired in parallel to monitor a variety of different zones.

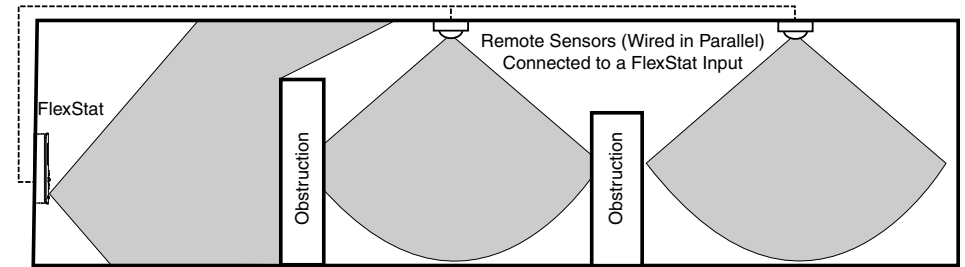

An example Control Basic program (for BACstage or TotalControl) that turns occupancy override on from remote sensors is:

```
IF AI2 < 1 THEN START BV40 : REM START EXTERNAL OCC
SNSR BV IF INPUT IS SHORTED
IF AI2 > 1 THEN STOP BV40 : REM STOP EXTERNAL OCC
SNSR BV IF INPUT IS OPEN
IF BV40 AND NOT BV1 THEN START BV2 : REM IF EXTER-
NAL OCC SNSR BV IS ACTIVATED AND FLEXSTAT IS NOT
IN OCC, START OVRD MODE
```

NOTE: The application must have one unused input. Input #2 is used in this example and assumes Normally Open relays/switches in the remote sensors. In such a case, the input pull-up resistors should be set to 10K ohms, and SNSR2 in the Application menu must be set to NOT USED.

NOTE: To trigger the occupancy override, the remote sensor **contacts must stay closed for two seconds or longer.**

NOTE: This program will work with the built-in motion sensor enabled or disabled. It will also work with FlexStat models that have no built-in motion sensor.

NOTE: See important information about custom programming in [Custom Programming on page 14](#).

Troubleshooting Motion Sensor Operation

- The initial firmware (R.1.0.0.0 and earlier) did not support this sensor within the built-in selectable programs. Custom programming was required. Upgrade to the latest firmware for built-in support.
- After an initial power-up or restart, the motion sensor requires about 30 seconds before it will begin responding to motion.
- The motion sensor initiates override only during “off” times in the schedule. Check the schedule.
- Check that the motion sensor is enabled and detects motion. See [Enabling/Disabling the Sensor and Override Time on page 30](#).
- Using BACstage or TotalControl, check that BI6 (occ status) is not configured as “Out of Service.”
- See [Performance and Applications on page 29](#) about effective range, false detections, and other detection issues.
- The FlexStat must be installed where there is a clear view of typical occupancy movement (reliable range is out to about 33 feet). Remove or move obstacles. Reinstall the FlexStat in a more optimal location if necessary. See also [Adding a Door Contact for Additional Control on page 31](#).
- For extended range or views around obstacles, connect remote motion sensors to an input. See [Adding Remote Motion Sensors on page 32](#).
- For the program in [Customizing the Motion Sensor and Override on page 30](#), Occupancy Override time in the System menu must **not** be set to 0.

Support

FlexStats come with a printed Installation Guide. The [latest support files](#) for the FlexStat are always available on the award-winning KMC Controls web site (www.kmcontrols.com). You may need to log-in to the Partners site (<https://partners.kmcontrols.com>) to see all available files.

The collection of FlexStat documents won a prestigious publications award for technical marketing support from the Chicago chapter of the Society for Technical Communication in March 2010.

For operation, configuration, troubleshooting and other information, see the [FlexStat Operation Guide](#).

For specifications, see the [FlexStat Data Sheet](#).

For additional instructions on programming, see the Help system for BACstage or TotalControl.



Important Notices

The KMC logo is a registered trademark and FlexStat, TotalControl, and BACstage are trademarks of KMC Controls, Inc. All rights reserved. No part of this publication may be reproduced, transmitted, transcribed, stored in a retrieval system, or translated into any language in any form by any means without the written permission of KMC Controls, Inc.

The material in this document is for information purposes only. **The contents and the product it describes are subject to change without notice.** KMC Controls, Inc. makes no representations or warranties with respect to this document. In no event shall KMC Controls, Inc. be liable for any damages, direct or incidental, arising out of or related to the use of this document.

BAC-1xx63/1xxx63 Series (6 Relays and 3 Analog Outputs)

This section is specific to the BAC-1xx63/1xxx63 series (with 6 relays and 3 analog outputs). **Model numbers with the additional digit** (BAC-12xxxx, 13xxxx, and BAC-14xxxx) **have three additional inputs and options for CO₂ sensing** (BAC-13xxxx and BAC-14xxxx) **and IP network connections** (BAC-1xxxxxE).

NOTE: See also the [FlexStat Catalog Supplement and Selection Guide \(SP-091\)](#).

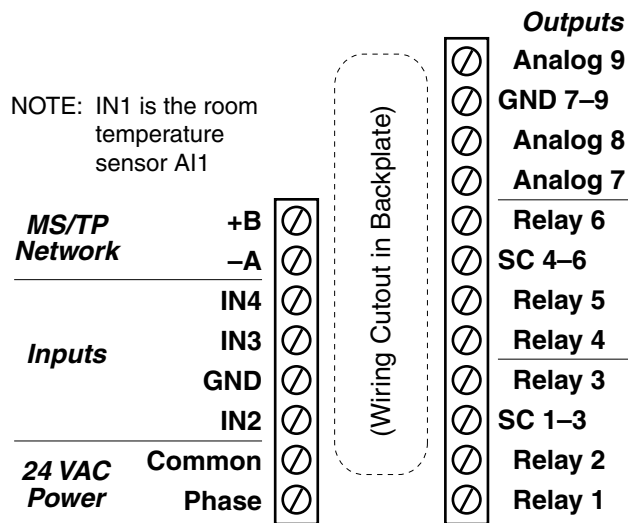

BAC-1xx63 Terminals

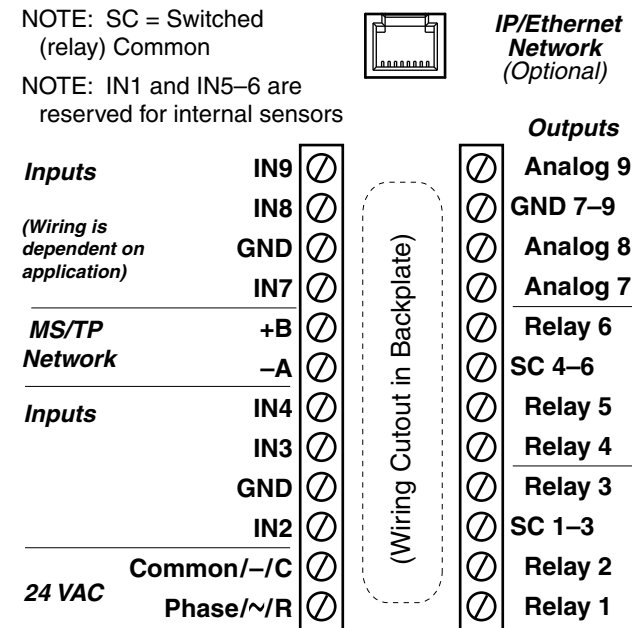

BAC-12xx63 Terminals (BAC-13xx63/14xx63 Terminals Are Rotated 90°)

Bills of Materials (BAC-1xx63/1xxx63)

This section contains BOMs for the sample installation diagrams in the corresponding sections of the BAC-1xx63 and BAC-1xxx63 installation guides. See those documents for detailed drawings and input/output connections as well as other important installation information.

AHU (Air Handling Unit)—Modulating Heat and Modulating Cool

BILL OF MATERIALS: AHU, Modulating Heat and Modulating Cool		
REFERENCE	KMC PART #	PART DESCRIPTION
FLEXSTAT	BAC-1xx63/ 1xxx63	BACNET THERMOSTAT, 6 RELAY & 3 ANALOG OUTPUTS
R1	REE-3211	MULTI-VOLTAGE CONTROL RELAY, 1.2 VA
CLV	VEB-43xxxBDL	FAIL-SAFE CONTROL VALVE, W/ MEP-5372 2-10 VDC ACTUATOR, 19 VA
HTV		
FOR VALVES, CHOOSE CAPACITY/MODEL FROM KMC DATA SHEET		
DAT	STE-1402	DUCT TEMPERATURE SENSOR
FST	CSE-1102	AIR DIFFERENTIAL PRESSURE SWITCH, 0.05-12" WC
MAT	STE-1416	12' DUCT AVERAGING TEMP SENSOR
OAT	STE-1451	OUTSIDE TEMPERATURE SENSOR
*	STE-6011	REMOTE TEMPERATURE SENSOR, TYPE II
*	SAE-10xx	REMOTE CO ₂ SENSOR, SPACE OR DUCT
TX1	XEE-6311-075	TRANSFORMER, 120/240/277/480:24 VAC, 75 VA
CHOOSE ONE OF THE FOLLOWING TRANSFORMERS:		
TX2	XEE-6311-075	TRANSFORMER, 120/208/240/480:24 VAC, 75 VA
TX2	XEE-6311-100	TRANSFORMER, 120/240/277/480:24 VAC, 96 VA
<i>*The remote temperature and CO₂ sensor options are not shown in the sample installation diagrams, and they are available only on BAC-12xxxx/13xxxx/14xxxx models.</i>		

NOTE: See also the RTU section for 2-stage options.

NOTE: See also [Sequence of Operation \(BAC-1xx63/1xxx63\) on page 38](#).

NOTE: Do not use REE-3211 relays with **analog** outputs! See [Connecting Outputs on page 13](#).

BILL OF MATERIALS: AHU, DAMPER ACTUATORS			
REFERENCE	MAX DAMPER AREA IN FT ²	KMC PART #	PART DESCRIPTION
OAD or RTD	6.25	MEP-5372	50 IN·LB FAIL-SAFE ACTUATOR, 2-10VDC, 19VA
OAD or RTD	15	MEP-7252	120 IN·LB FAIL-SAFE ACTUATOR, 0-10VDC, 25VA
OAD or RTD	22.5	MEP-7552	180 IN·LB FAIL-SAFE ACTUATOR, 0-10VDC, 25VA
OAD or RTD	40	MEP-7852	320 IN·LB FAIL-SAFE ACTUATOR, 0-10VDC, 40VA

NOTE: Remote temperature and CO₂ sensors are available only on BAC-12xxxx/13xxxx/14xxxx models. When IN7 is configured for a remote space temperature sensor, space temperature can be configured for onboard, remote, averaging of the two, the lowest reading, or the highest reading. When DCV is enabled in the BAC-12xxxx (without a built-in CO₂ sensor), IN9 is assumed to be connected to an external SAE-10xx CO₂ sensor. BAC-13xxxx/14xxxx FlexStats also have the external CO₂ sensor option, and if used, the highest of the two readings (internal vs. external) will be used to control DCV sequences. See the [FlexStat Operation Guide](#) for more details.

HPU (Heat Pump Unit)— 1 or 2 Compressors w/ Aux. & Emergency Heat

BILL OF MATERIALS: HPU, 1/2 Compressors w/ Aux. & Emergency Heat		
REFERENCE	KMC PART #	PART DESCRIPTION
FLEXSTAT	BAC-1xx63/ 1xxx63	BACNET THERMOSTAT, 6 RELAY & 3 ANALOG OUTPUTS
DAT	STE-1402	DUCT TEMPERATURE SENSOR
FST	CSE-1102	AIR DIFFERENTIAL PRESSURE SWITCH, 0.05-12" WC
MAT	STE-1416	12' DUCT AVERAGING TEMP SENSOR
OAT	STE-1451	OUTSIDE TEMPERATURE SENSOR
*	STE-6011	REMOTE TEMPERATURE SENSOR, TYPE II
*	SAE-10xx	REMOTE CO ₂ SENSOR, SPACE OR DUCT
CHOOSE ONE OF THE FOLLOWING TRANSFORMERS:		
TX2	XEE-6311-075	TRANSFORMER, 120/208/240/480:24 VAC, 75 VA
TX2	XEE-6311-100	TRANSFORMER, 120/240/277/480:24 VAC, 96 VA
<i>*The remote temperature and CO₂ sensor options are not shown in the sample installation diagrams, and they are available only on BAC-12xxxx/13xxxx/14xxxx models.</i>		

BILL OF MATERIALS: HPU, DAMPER ACTUATORS			
REFERENCE	MAX DAMPER AREA IN FT ²	KMC PART #	PART DESCRIPTION
OAD or RTD	6.25	MEP-5372	50 IN·LB FAIL-SAFE ACTUATOR, 2-10VDC, 19VA
OAD or RTD	15	MEP-7252	120 IN·LB FAIL-SAFE ACTUATOR, 0-10VDC, 25VA
OAD or RTD	22.5	MEP-7552	180 IN·LB FAIL-SAFE ACTUATOR, 0-10VDC, 25VA
OAD or RTD	40	MEP-7852	320 IN·LB FAIL-SAFE ACTUATOR, 0-10VDC, 40VA

NOTE: On BAC-12xxxx/13xxxx/14xxxx models, when IN7 is configured for a remote space temperature sensor, space temperature can be configured for onboard, remote, averaging of the two, the lowest reading, or the highest reading. When DCV is enabled, IN9 is assumed to be connected to an external SAE-10xx CO₂ sensor. See the [FlexStat Operation Guide](#) for more details.

RTU (Roof Top Unit)—1 or 2 Heat and 1 or 2 Cool

BILL OF MATERIALS: RTU, 1 or 2 Heat and 1 or 2 Cool		
REFERENCE	KMC PART #	PART DESCRIPTION
FLEXSTAT	BAC-1xx63/ 1xxx63	BACNET THERMOSTAT, 6 RELAY & 3 ANALOG OUTPUTS
DAT	STE-1402	DUCT TEMPERATURE SENSOR
FST	CSE-1102	AIR DIFFERENTIAL PRESSURE SWITCH, 0.05-12" WC
MAT	STE-1416	12' DUCT AVERAGING TEMP SENSOR
OAT	STE-1451	OUTSIDE TEMPERATURE SENSOR
*	STE-6011	REMOTE TEMPERATURE SENSOR, TYPE II
*	SAE-10xx	REMOTE CO ₂ SENSOR, SPACE OR DUCT
CHOOSE ONE OF THE FOLLOWING TRANSFORMERS:		
TX2	XEE-6311-075	TRANSFORMER, 120/208/240/480:24 VAC, 75 VA
TX2	XEE-6311-100	TRANSFORMER, 120/240/277/480:24 VAC, 96 VA
<i>*The remote temperature and CO₂ sensor options are not shown in the sample installation diagrams, and they are available only on BAC-12xxxx/13xxxx/14xxxx models.</i>		

BILL OF MATERIALS: RTU, DAMPER ACTUATORS			
REFERENCE	MAX DAMPER AREA IN FT ²	KMC PART #	PART DESCRIPTION
OAD or RTD	6.25	MEP-5372	50 IN·LB FAIL-SAFE ACTUATOR, 2-10VDC, 19VA
OAD or RTD	15	MEP-7252	120 IN·LB FAIL-SAFE ACTUATOR, 0-10VDC, 25VA
OAD or RTD	22.5	MEP-7552	180 IN·LB FAIL-SAFE ACTUATOR, 0-10VDC, 25VA
OAD or RTD	40	MEP-7852	320 IN·LB FAIL-SAFE ACTUATOR, 0-10VDC, 40VA

NOTE: This was 2 Heat and 2 Cool in firmware R1.3.04 and earlier. Multistage was added later.

NOTE: See the corresponding [BAC-1xx63](#) or [BAC-1xxx63](#) Installation Guide section for detailed drawings and input/output connections as well as other important installation information.

FCU (Fan Coil Unit)—2 or 4 Pipe, Modulating or 2 Position

BILL OF MATERIALS: FCU, 2-Pipe, 2-Position		
REFERENCE	KMC PART #	PART DESCRIPTION
FLEXSTAT	BAC-1xx63/ 1xxx63	BACNET THERMOSTAT, 6 RELAY & 3 ANALOG OUTPUTS
R1, R2, R3	REE-3211	MULTI-VOLTAGE CONTROL RELAY, 1.2 VA
VLV	VEZ-4xxxxMBx	FAIL-SAFE CONTROL VALVE, 24 VAC, 14 VA
FOR VALVE, CHOOSE CAPACITY/MODEL FROM KMC DATA SHEET		
DAT	STE-1402	DUCT TEMPERATURE SENSOR
FST	CSE-1102	AIR DIFFERENTIAL PRESSURE SWITCH, 0.05-12" WC
W-TMP	STE-1454/1455	2" STRAP-ON TEMPERATURE SENSOR (w/ or w/o enclosure)
*	STE-6011	REMOTE TEMPERATURE SENSOR, TYPE II
TX1	XEE-6311-050	TRANSFORMER, 120/240/277/480:24 VAC, 50 VA
*The remote temperature sensor option is not shown in the sample installation diagrams, and it is available only on BAC-12xxxx/13xxxx/14xxxx models.		

BILL OF MATERIALS: FCU, 2-Pipe, Modulating		
REFERENCE	KMC PART #	PART DESCRIPTION
FLEXSTAT	BAC-1xx63/ 1xxx63	BACNET THERMOSTAT, 6 RELAY & 3 ANALOG OUTPUTS
R1, R2, R3	REE-3211	MULTI-VOLTAGE CONTROL RELAY, 1.2 VA
VLV	VEB-43xxxBCK	CONTROL VALVE W/ MEP-4002 0-10V ACTUATOR, 4 VA
FOR VALVE, CHOOSE CAPACITY/MODEL FROM KMC DATA SHEET		
DAT	STE-1402	DUCT TEMPERATURE SENSOR
FST	CSE-1102	AIR DIFFERENTIAL PRESSURE SWITCH, 0.05-12" WC
W-TMP	STE-1454/1455	2" STRAP-ON TEMPERATURE SENSOR (w/ or w/o enclosure)
*	STE-6011	REMOTE TEMPERATURE SENSOR, TYPE II
TX1	XEE-6311-050	TRANSFORMER, 120/240/277/480:24 VAC, 50 VA
*The remote temperature sensor option is not shown in the sample installation diagrams, and it is available only on BAC-12xxxx/13xxxx/14xxxx models.		

NOTE: Humidity and motion/occupancy sensor options are dependent on FlexStat model. Demand Control Ventilation is not available with FCU applications.

NOTE: Do not use REE-3211 relays with **analog** outputs! See [Connecting Outputs on page 13](#).

BILL OF MATERIALS: FCU, 4-Pipe, 2-Position		
REFERENCE	KMC PART #	PART DESCRIPTION
FLEXSTAT	BAC-1xx63/ 1xxx63	BACNET THERMOSTAT, 6 RELAY & 3 ANALOG OUTPUTS
R1, R2, R3	REE-3211	MULTI-VOLTAGE CONTROL RELAY, 1.2 VA
CLV	VEZ-4xxxxMBx	FAIL-SAFE CONTROL VALVE, 24 VAC, 14 VA
HTV		
FOR VALVES, CHOOSE CAPACITY/MODEL FROM KMC DATA SHEET		
DAT	STE-1402	DUCT TEMPERATURE SENSOR
*	STE-6011	REMOTE TEMPERATURE SENSOR, TYPE II
TX	XEE-6311-050	TRANSFORMER, 120/240/277/480:24 VAC, 50 VA
*The remote temperature sensor option is not shown in the sample installation diagrams, and it is available only on BAC-12xxxx/13xxxx/14xxxx models.		

BILL OF MATERIALS: FCU, 4-Pipe, Modulating		
REFERENCE	KMC PART #	PART DESCRIPTION
FLEXSTAT	BAC-1xx63/ 1xxx63	BACNET THERMOSTAT, 6 RELAY & 3 ANALOG OUTPUTS
R1, R2, R3	REE-3211	MULTI-VOLTAGE CONTROL RELAY, 1.2 VA
CLV	VEB-43xxxBCK	CONTROL VALVE W/ MEP-4002 0-10V ACTUATOR, 4 VA
HTV		
FOR VALVES, CHOOSE CAPACITY/MODEL FROM KMC DATA SHEET		
DAT	STE-1402	DUCT TEMPERATURE SENSOR
FST	CSE-1102	AIR DIFFERENTIAL PRESSURE SWITCH, 0.05-12" WC
*	STE-6011	REMOTE TEMPERATURE SENSOR, TYPE II
TX	XEE-6311-050	TRANSFORMER, 120/240/277/480:24 VAC, 50 VA
*The remote temperature sensor option is not shown in the sample installation diagrams, and it is available only on BAC-12xxxx/13xxxx/14xxxx models.		

NOTE: See also [Sequence of Operation \(BAC-1xx63/1xxx63\) on page 38](#).

NOTE: See the corresponding BAC-1xx63 or BAC-1xxx63 **Installation Guide** section for detailed drawings and input/output connections as well as other important installation information.

Sequence of Operation (BAC-1xx63/1xxx63)

NOTE: This information reflects firmware version R2.0.0.13 or later (but specifications and sequences are subject to change and may vary according to model and options).

FlexStat (All Models) Common Features

Space Temperature Setpoints and Modes

The first step in setting up an unconfigured FlexStat is to select the units of operation, Celsius or Fahrenheit. Once set, temperature values are adjusted in both firmware and Control Basic for the proper values/units.

The most basic operating parameters controlling the FlexStats operation are the space temperature setpoints. There are **four setpoints** during normal operation of the FlexStat; unoccupied heating setpoint, unoccupied cooling setpoint, occupied heating setpoint and occupied cooling setpoint.

Likewise, there are **four corresponding setpoint limiters**: unoccupied heating max, unoccupied cooling min, occupied heating max, and occupied cooling min. When the setpoints are adjusted from the FlexStat's user interface display, firmware applies the appropriate limit to the setpoint being edited.

Another limit that applies to setpoints is the **minimum setpoint differential**. This differential is adjustable via the user interface. It cannot, however, be set less than the minimum setpoint differential limit (default of 1° F/C), which itself is only adjustable from interface software. The function of the limit works in two ways. If either the occupied or unoccupied heating setpoint is being edited from the user interface, it cannot be raised any closer to the corresponding occupied or unoccupied cooling setpoint than the minimum setpoint differential even if the heating setpoint being edited is less than its maximum limit. Conversely, if the occupied or unoccupied cooling setpoint is being edited from the user interface, the cooling setpoint is allowed to be adjusted down to its minimum limit. However, the corresponding occupied or unoccupied heating setpoint is always maintained at this minimum setpoint differential distance from the cooling setpoint with the heating setpoint being lowered if necessary.

The FlexStat controls its output operations based on two setpoints, **active heating setpoint and active cooling setpoint**. Under normal, non-override operation, these setpoints are set, based on the current schedule state being on, to either the occupied heating and occupied cooling setpoints. If the present schedule state is off, then the active heating and active cooling setpoints are set to the unoccupied heating and unoccupied cooling setpoints. Active heating and cooling setpoints can be set to other values under the circumstances described in the occupancy override sequence under the Occupancy Mode section and when the unit is in Standby Mode as described in the Standby Mode section.

Heating Proportional Band and Cooling Proportional Band (both previously combined and called "Deadband" in firmware R1.4.0.1 and earlier) are adjustable from the user interface and are used in staging or modulating the outputs throughout the various application configurations. Specific uses of both proportional bands are described further in the sequence information in the following pages. (The parameter Minimum Proportional governs the lower limits of both proportional bands and is adjustable only from interface software.)

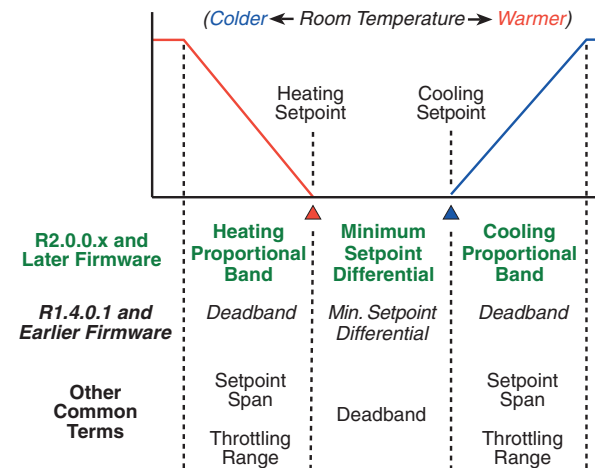

The current heating/cooling mode of the FlexStat is displayed on the user interface. This mode determines which outputs are energized based on space temperature and active setpoint values. The heating/cooling mode is set to heating if the space temperature falls below the active

heating setpoint. If the space temperature rises above the active cooling setpoint, the heating/cooling mode is set to cooling.

The heating/cooling mode can also be manually set by adjusting the “**System Mode**” through the user interface. The System Mode can be set to Auto, Heat, Cool and Off. On the heat pump application, the System Mode can also be set to Emergency Heat. If the System Mode is set to Auto, the FlexStat will automatically determine the heating or cooling mode as described above. Setting the System Mode to “Heat” or “Cool” (or Emer Ht) forces the unit into that mode. Setting the System Mode to “Off” turns off all heating and cooling functions but has no effect on fan control.

Occupancy Modes

Occupied mode is normally determined by the weekly schedule. It is used for determining which space temperature setpoints to use, whether to run the fan in constant or intermittent mode and whether to ventilate (outside air damper minimum position) or not.

In addition to temporarily placing the controller into the occupied mode if it is not already in occupied mode, **occupancy override is used to temporarily override the space temperature** setpoints for a predetermined period of time. As such, occupancy override may be activated during either occupied mode or unoccupied mode. This is done by either changing the setpoint via the Up/Down buttons from the home screen of the FlexStat or starting the override mode from the override menu (Left and then Enter buttons on the OCC icon of the home screen).

Additionally, on models with the **motion/occupancy sensor** option, occupancy override may be activated via motion detected by the motion sensor if the Occupancy Override Sensor option is enabled. This option will only activate occupancy override during the unoccupied mode.

Once activated, the occupancy override mode functions in one of two ways, depending on configuration. After initial activation (if the occupancy override timer is set to a non-zero value), the occupancy override mode will turn itself off when the timer expires. Alternately, it will turn off at the next schedule change if that comes first.

If the override timer value is set to zero, the schedule state (occupied or unoccupied) is logged just prior to the activation of the override mode. Once activated in this zero timer mode, the occupancy override will

expire upon the next normal scheduled change of state of the scheduled occupied mode. The following two examples illustrate this operation. For both examples, assume the override timer is set to zero and the scheduled occupied mode is on at 8:00 AM and off at 5:00 PM:

- Example 1. The override mode is activated at 4:57 PM. The occupancy override starts at 4:57 PM and expires at 5:00 PM.
- Example 2. The override mode is activated at 5:01 PM. The occupancy override starts at 5:01 PM and expires at 8:00 AM the following morning.

How the override mode affects temperature setpoints depends on how the mode was initiated:

If the mode was initiated from entering on the occupancy icon on the home screen, the FlexStat will maintain the normal occupied heating and occupied cooling setpoints until the expiration of the override mode.

If the override mode was initiated by modifying the setpoint via the up/down buttons of the home screen on the user interface, then the active setpoint of the current heating or cooling mode is adjusted according to the buttons. The complimentary active setpoint (i.e., cooling, if the FlexStat is presently in the heating mode) is then set to the minimum setpoint differential away from the present mode active setpoint (limits allowing). The FlexStat will attempt to maintain the space temp setpoint as entered at the start of the occupied override mode. However, minimum setpoint differential and occupied heating max and occupied cooling min limits still apply to override mode setpoint adjustments and operations.

If, during occupancy override mode via setpoint adjust, the unit is in heating mode and the temperature passes the active cooling setpoint, the active mode becomes cooling. The active cooling setpoint then becomes the old active heating setpoint and the active heating setpoint is lowered by the minimum setpoint differential. Again, occupied heating max and occupied cooling min limits still apply. Similar setpoint swapping occurs if the unit was in the cooling mode and the temperature falls below the active heating setpoint.

The FlexStat is considered in the “occupied” mode whether it is set by normal schedule operation or occupied override mode. If the FlexStat is not scheduled on or in the occupancy override mode, it is considered in “unoccupied” state.

Optimum Start

NOTE: Optimum Start was added in firmware ver. R2.0.0.9.

Optimum Start uses historical performance data, outside temperature, and length of the unoccupied period to calculate a pre-start time needed to arrive near occupied space temperature setpoints at a scheduled time. Optimum Start is enabled by setting OS Enable to ENABLE.

At midnight, Optimum Start reads and uses only the first scheduled ON time for that day, and uses the following factors in calculating the optimal start time:

- Three hours before scheduled occupancy, the pre-start time is calculated based on current space temperature and historical warm-up/cool-down performance data.
- **IF an outdoor air temperature sensor is installed (wired to AI4), and IF today's OAT is 15° F (8.3° C) more conducive to warm-up/cool-down than yesterday's (i.e., if in cooling mode and it's 15° F cooler today than yesterday or if in heating mode and it's 15° F warmer), the pre-start time is decreased by 10%. If today's OAT is 15° F (8.3° C) less conducive than yesterday's, the pre-start time is increased by 10%.**
- IF the schedule has been unoccupied for more than 24 hours, the pre-start time is increased by 15%.
- The final calculated pre-start time is limited to between 15 minutes minimum and 3 hours maximum.

Optimum Start is considered satisfied when the space temperature is within 0.5 times the currently active setpoint span of the occupied setpoint. The length of time to reach Optimum Start being satisfied is then used to calculate today's performance. This in turn is used to calculate the historical performance rate for tomorrow's use. The last three days performance are used to calculate the performance rate giving 3 times weight to today's rate, 2 times weight to yesterdays and 1 times weight to 2 days ago performance.

During Optimum Start mode, Occupied Mode is turned on and the unit controls accordingly with the exception of Economizer Minimum Position. If the unit is configured for economizer, during Optimum Start,

Econ Minimum Position is held to zero as ventilation is not needed until scheduled occupancy begins.

Optimum Stop calculates the time before the scheduled off time that the space temperature (without heating or cooling) may be allowed to "drift" without exceeding the setpoint proportional band or span. (Normal ventilation will continue until the scheduled off time.)

NOTE: For maximum efficiency, if Optimum Start is enabled, set times in schedules for when the room temperature should reach the setpoint, not when heating/cooling equipment should start (which would be earlier). Likewise, if Optimum Stop is enabled, set Off times for when room temperature no longer needs to be maintained at the occupied setpoint, not when equipment should stop.

Standby Mode

NOTE: Standby Mode was added in firmware ver. R2.0.0.9.

On units equipped with a motion/occupancy sensor, Standby Mode is available. Standby capability is enabled by setting Standby to Enable.

Standby Mode can only be entered into during the Occupied mode. If Standby is enabled, Standby Mode is active if no motion is sensed for the duration of the Standby Timer (30 minutes default). Once Standby Mode is active, the active heating setpoint is set to the occupied heating setpoint minus the Standby Offset (default 3° F or 1.6° C) and the active cooling setpoint is set to the occupied cooling setpoint plus the Standby Offset.

Upon detecting motion two times in three minutes, Standby Mode stops. Although occupancy mode returns immediately to normal Occupied Mode, the active setpoints transition from standby setpoints to normal occupied setpoints over time. The active setpoints move 1° F (0.55° C) closer to the occupied setpoints every fifteen minutes beginning immediately when Standby Mode stops. This continues until the active setpoints reach their normal occupied setpoint values.

During Standby Mode, economizer minimum position is held to zero.

If a building automation system is present, the unit can manually be put into Standby Mode by overriding BV36 (Standby Mode) to ON at priority 8. To return the unit to normal function, relinquish BV36@P8.

Fan Control

The following is the base sequence for fan operation.

The occupied and the unoccupied modes have separate configurations for fan control. Each scheduled mode can be configured to operate the fan in either continuous or automatic mode.

If the configuration for a particular occupancy mode is set to “On,” there will be a continuous call for fan during that scheduled state. If the fan is set to “Auto,” the fan will cycle only on a call for heating or cooling. Because PI control is used in heating and cooling, values may be slightly skewed, but generally a call for heating turns on at active heating setpoint (minus heating proportional band) and off at active heating setpoint. Generally, a call for cooling turns on at active cooling setpoint (plus cooling proportional band) and off at active cooling setpoint.

There are certain application-specific variations of how the fan control functions that are detailed in the specific application sections below.

The FlexStat has two options concerning fan status:

- If the Sensor 2 option is set to either “not used” or “discharge air temp,” the unit is configured to not have fan status. The fan motor is then assumed to always respond when commanded to run.
- If the unit is configured to have fan status, and if the fan is commanded to run and the FlexStat does not see a response on the fan status input within 5 seconds, a fan alarm is generated. **Upon fan alarm, all outputs other than the fan are de-energized.**

There is a fan status icon on the user interface that indicates the fan run command status. This is controllable through Control Basic.

For heating applications, Heating Fan is set to Auto by default but can be disabled in the fan configuration menu if needed (such as for an FCU that is factory wired to run at a fixed speed or for a baseboard heater without a fan). The Heating Fan selection is only available when the application supports heating and either Occupied fan or Unoccupied fan is set to Auto.

If a low limit alarm is present, all fan outputs are de-energized.

Sensor 2 (Fan Status or Discharge Air Temp)

An option, Sensor 2, determines the use of analog input #2. If sensor 2 is configured for fan status, the FlexStat performs the fan control sequence as described above. If sensor 2 is configured for discharge air temp, the FlexStat configures analog input #2 for a 10K type III thermistor. This selection is intended for monitoring discharge air temperature of the HVAC unit.

Note: This selection is for monitoring only — there is no HVAC control associated when selecting discharge air temp. Additionally, a trend log is set up for discharge air temp with a 10 minute interval. Lastly, sensor 2 may be configured for “not used.”

Economizer

Certain applications can be configured for an economizer option. If the economizer option is enabled, the economizer mode is determined by comparing **outside air temperature (OAT)** to the economizer enable temperature. The economizer mode is enabled if the OAT is 1.0° F (0.56° C) below the economizer enable temperature and disabled if the OAT is 1.0° F (0.56° C) above the econ enable temp.

During occupied mode, if the economizer mode is enabled, the outside air damper will open to the greater of the minimum damper position setting (adjustable, for ventilation) or the mixed air temperature PI loop. The mixed air temp loop will modulate from 0 to 100% as the mixed air temp rises above the mixed air temp setpoint.

The PI loop “P” component is calculated and reset based on an OAT reset schedule. “P” increases as OAT gets colder, adding loop stability at colder OA temperatures. When the OAT is at or above 3° F (1.67° C) below MAT Min Temp (53° F or 11.7° C), the Econ Loop (LOOP4) “P” factor is set to OAD Warm Temp (15° F or 8.3° C). The Econ Loop “P” factor is set to OAD Cold Temp (30° F or 16.7° C) when the OAT is at or below twice the difference between the above calculated temperature (3° F below MAT Min Temp) and MAT Low Limit (45° F or 7.2° C). The “P” factor resets linearly in between the above values. The following table illustrates various “P” factor values using the default Fahrenheit settings:

OAT	Econ Loop “P” factor
65	15
53	15
50	15
45	22.5
40	30
30	30

During occupied mode, the mixed air temp setpoint is determined based on a reset schedule. If the space temperature is at or below the active cooling setpoint, the mixed air temp setpoint is MAT Max Temp (68.0° F or 20.0° C). If the space temperature is 2.0° F (1.1° C) above the active cooling setpoint, the mixed air temp setpoint will be MAT Min Temp (53.0° F or 11.7° C). The mixed air setpoint will vary linearly in between. MAT Min Temp and MAT Max Temp are adjustable from the U/I.

During unoccupied mode, if the space temp exceeds the cooling setback setpoint by cooling proportional band and the econ mode is enabled, the outside air damper shall open as called for by the mixed air temp loop. The outside air damper shall modulate to maintain MAT Min (53.0° F or 11.7° C) until the space temp reaches the cooling setback setpoint, at which point it shall close. If at any time during unoccupied mode the economizer mode is disabled based on OAT, the outside air damper will close.

If the system mode is set to “heating” during occupied mode, the damper will open to minimum position when the fan is on. If the system mode is set to “heating” during unoccupied mode or is set to “off” in any occupancy mode, the outside damper will close. **If at any time there is a fan alarm, the outside air damper shall shut.**

If the mixed air temp drops below the low limit alarm temp, a low limit alarm is generated and the outside air damper will close. Other safety actions are taken and described in their respective sections below.

DCV (Demand Controlled Ventilation)—General Information

NOTE: See also [CO2 Sensors and DCV on page 21](#).

In addition to the Economizer option, BAC-12xxxx/13xxxx/14xxxx models have the Demand Control Ventilation (DCV) option available. DCV combines several options and modes into efficiently controlling the outside air damper. DCV is enabled by setting DCV to one of the three configurations.

The various Outside Air (OA) % settings that are available are the percentage that the OA damper is open and not the percentage of OA flow. These settings should be measured and set accordingly.

The controller is designed to operate without an outside CO₂ sensor using a reference **CO2 Base** level (400 ppm default). This setting is adjustable from the U/I and should be set to the local average outdoor CO₂ level. If an outdoor CO₂ reference is desired, a spare input on the Flex-Stat can be used and mapped to AV60. This should be done at priority 8 or higher (higher priority = lower number).

The three types of DCV configurations available are:

- **BASIC**—Provides simple DCV, modulating the outside air damper in direct response to the current CO₂ level with respect to its setpoint. Basic DCV is much more energy efficient than no DCV at all, while maintaining adequate IAQ (Indoor Air Quality). It is the easiest DCV method to configure. However, where VOCs, radon, or other pollutants become excessive during unoccupied times (with no ventilation), the FlexStat’s Standard or Advanced DCV configuration is recommended.
- **STANDARD**—When the BAC-13xxxx settings are properly configured, complies with [CA Title 24, Section 121\(c\)](#). This would also apply to a properly configured BAC-12xxxx with a remote SAE-10xx CO₂ sensor. Standard DCV, under most conditions, is somewhat less energy efficient than Basic, but it enhances IAQ.*

*NOTE: The CO₂ sensors in the BAC-13xxxx series FlexStats (as well as properly configured SAE-10xx CO₂ detectors) have been certified to comply with CA Title 24, Section 121(c), as well as sub-paragraph 4.F that specifies accuracy will be maintained within tolerance for a minimum of 5 years without recalibration. **See the data sheet for more information.**

- **ADVANCED**—When the settings are properly configured, this configuration complies with **CA Title 24, Section 121(c)** and **ASHRAE Standard 62.1-2010** and follows guidelines by **Portland Energy Conservation, Inc. (PECI)**. Although Advanced DCV is the most complex to configure, it is more energy efficient than Standard while still optimizing IAQ.

NOTE: See the **FlexStat Operation Guide** for more information about configuring DCV.

DCV—Basic Configuration

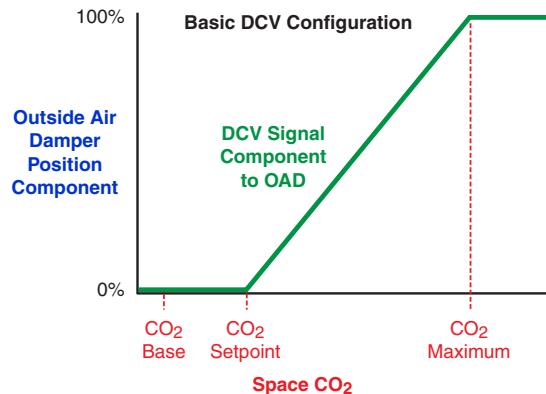

During occupied mode, the OA damper opens to Min Position. Upon Space CO₂ rising above CO₂ Setpt (600 ppm default), the damper begins to modulate open from Min Position. The damper modulates fully open as Space CO₂ rises to CO₂ Max (1000 ppm default).

NOTE: The three DCV Configuration graphs show the DCV **component** of the signal to the outside air damper. Depending on the conditions and the DCV configuration, the signal to the damper might be controlled by Minimum Position, Economizer Loop, or other components. The **maximum** of these component values is used, not the sum of them. (If there is a Low Limit alarm, however, these signals are overridden, and the damper is closed.)

DCV—Standard Configuration

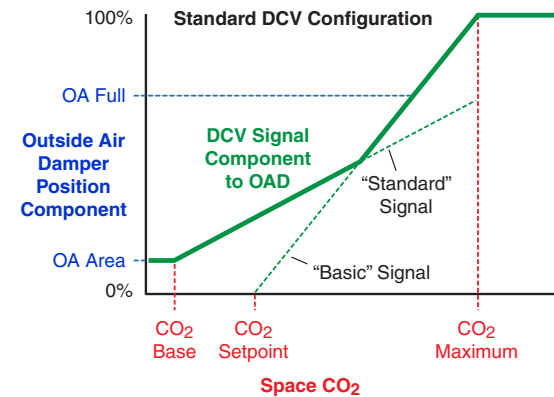

During occupied mode, the OA damper opens to Min Position. Similar to Basic DCV mode, Standard DCV mode has a PID loop that increases its output as Space CO₂ rises from CO₂ Setpt to CO₂ Max. Standard DCV mode also has two additional settings, OA Area (2% default) and OA Full (5% default). As Space CO₂ rises from CO₂ Base to CO₂ Max, an internal value is calculated rising proportionally from OA Area to OA Full. At any point in time during occupied mode, the OA damper is open the greater of Min Position, the CO₂ Setpt loop, or the internally calculated OA position.

DCV—Advanced Configuration

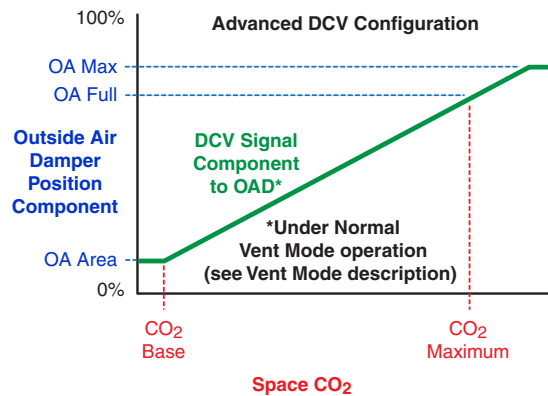

Ventilation Startup

If OA Purge is set to zero (default) and motion/occupancy is sensed during the first 20 minutes immediately following scheduled Occupied mode, Ventilation mode is set to STARTUP and the fan is called for to run with the OA damper open to OA Recovery Position as calculated under the Ventilation Recovery Mode below. This mode ends 20 minutes after scheduled Occupied mode begins.

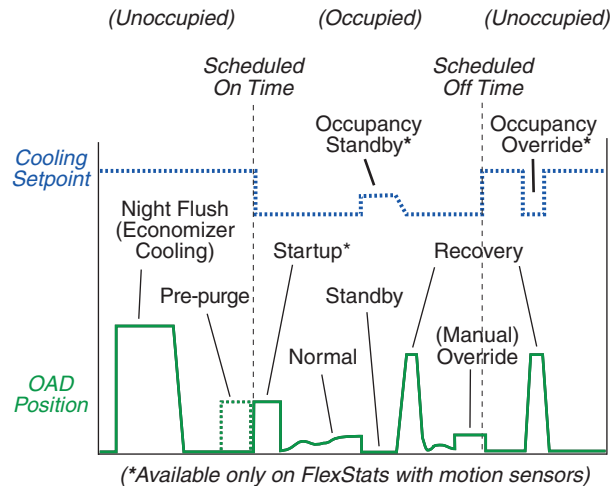

Normal Ventilation

During occupied mode, unless conditions warrant a different DCV mode, the default Ventilation mode is NORMAL (after Pre-purge, Start-up, or Recovery modes have finished and returned the ventilation rate to “normal” operation). During Normal ventilation mode, the damper modulates between OA Area (2% default) and OA Full (5% default) as follows with an increase above OA Full as described below.

OA Area is the damper position required to provide the outdoor air rate. (Note that this represents the **damper position**, not the minimum outside air percentage.) The OA damper shall be at this position when Space CO2 is at or below CO2 Base.

OA Full is the full damper position required to provide the combined people and area outdoor rate. The outside air damper shall be at this position when Space CO2 is at CO2 Max (1000 ppm default).

When Space CO2 is between CO2 Base and CO2 Max, the damper shall modulate proportionally between OA Area and OA Full.

When Space CO2 exceeds CO2 Max, the damper shall increase proportionally above OA Full limited by OA Max (40% default) using the same proportional gain as above.

Ventilation Recovery

When the supply fan is off unless in Standby mode, a ventilation recovery mode with supply fan operation shall be initiated for a variable length recovery period when either Space CO2 exceeds CO2 Max + 200 ppm or when the fan has been off for Fan Max Off (30 minutes default).

After the fan has been off and starts due to a heating or cooling call, Max Fan Off, or high CO2 level, the ventilation rate shall be increased to provide average ventilation that matches the ASHRAE Standard 62.1 ventilation rate for the prescriptive method.

Ventilation during this mode shall be limited to a maximum that is full damper opening (100% open) when outside air is temperate relative to space temperatures (typically between 65° F and 80° F) and ramps down to the OA Full setting at either heating or cooling design temperatures (20° F and 95° F respectively, adjustable). Ventilation shall operate for at least 5 minutes up to a time related to the ratio of the space CO2 concen-

tration at the end of the last fan operation period to CO2 Max and the allowed ventilation rate for this fan cycle. Should there be a continued call for heating or cooling after the recovery period is complete, Ventilation mode shall return to NORMAL.

Whenever the supply fan stops, Space CO2 is recorded (Space CO2 Last) at the time the fan stops. A timer, Fan Off Timer, keeps track of the elapsed time in minutes the supply fan was off during the occupied period since the end of the last fan operation or the end of the last Standby period.

Whenever the supply fan starts after an off period, except in Standby mode, the ventilation shall be maintained at the following position, OA Recov Pos:

1. If OA is above Clg Design Temp (95° F default) or below Htg Design Temp (20° F default), the OA damper shall be set to OA Full.
2. If OA is between OA Low Vent (65° F default) and OA High Vent (80° F default), the OA damper shall be set to 100% open.
3. If OA is between Htg Design Temp (20° F default) and OA Low Vent, the OA damper shall be proportionally set between OA Full and 100%.
4. If OA is between OA High Vent and Clg Design Temp (95° F default), the OA damper shall be proportionally set between 100% and OA Full.
5. OA Max does not apply during RECOVERY mode.

In order to find the ventilation recovery time (Fan Recov Timer), the fan recovery ratio (Fan Recov Ratio) must be calculated. Fan Recov Ratio is the prescriptive ventilation needed as a fraction of the rate ventilation air will be delivered during the RECOVERY period indicating the time the fan needs to operate relative to fan off time. Fan Recov Ratio is calculated as follows:

$$\text{Fan Recov Ratio} = (\text{People Portion} * (\text{CO2 Last} - \text{CO2 Base}) / (\text{CO2 Max} - \text{CO2 Base}) + 1 - \text{People Portion}) * (\text{OA Full} / \text{OA Recov Pos})$$

Where:

$$\text{People Portion} = (\text{OA \% Full} - \text{OA \% Area}) / (\text{OA \% Full})$$

and

$$\text{Fan Recov Timer} = 3 \text{ min} + [(\text{Fan Off Timer} + 5) * \text{Fan Recov Ratio}]$$

NOTE: **OA % Full** and **OA % Area** are internal AVs and are not the same as OA Full and OA Area, which are adjustable from the U/I.

During RECOVERY mode, the damper is set to OA Recov Pos while the supply fan operates for Fan Recov Timer minutes. The Ventilation Mode is set to RECOVERY during this period.

At the conclusion of the Fan Recov Timer period:

1. If there is a call for heating, cooling, or economizer that requires fan operation, Ventilation mode is set to NORMAL and ventilation proceeds accordingly.
2. If the Occupied Fan mode is set to AUTO and there is no call for heating, cooling, or economizer, the supply fan stops unless Space CO2 exceeds CO2 Max – 100 ppm, in which case the fan operates with the OA damper at OC Recov Pos as determined above until Space CO2 <= CO2 Max.

Economizer Ventilation

When economizer cooling is called for, the OA damper shall maintain the economizer setpoint or the ventilation setpoint, whichever is greater.

Ventilation Override Mode

When activated through the U/I or by setting Vent Ovr Mode to ON at priority 8 via software, a ventilation override mode shall activate the fan for Vent Ovr minutes (30 default) with the OA damper at OA Full.

Standby Mode (Requires a Motion Sensor)

If Standby operation is enabled and Standby Mode is ACTIVE, the following shall occur:

1. Active heating and cooling setpoints are adjusted as in normal STANDBY mode.
2. If the fan is operating, fan operation based on Fan Max Off shall be suspended and Fan Off Timer shall be reset to zero. If the fan is off when the STANDBY mode initiates, Fan Off Timer shall be suspended at its current value until occupancy is again detected.

3. During STANDBY mode, the outside damper shall be closed.
4. Upon leaving STANDBY mode and returning to NORMAL, the active heating and cooling setpoints return to normal following the same 1° F per 15 minute rate as described in the Standby mode sequence described above. Fan Off Timer resumes incrementing as normal.

The following DCV modes apply during Unoccupied mode:

Unoccupied Off

If Unocc Fan mode is set to AUTO, the supply fan shall be off except on a call for heating, call for cooling or when operation is called for as described below. Outside dampers shall remain closed when the fan is off.

Night Flush

Night Flush mode uses the economizer only to pre-cool the building, subject to the following conditions:

1. Night flush is intended to be seasonal, but may switch more than once during swing seasons. Night Flush Enable is ENABLED when OAT exceeds 70° F (21.1° C) and remains enabled until OAT drops below 45° F (7.2° C). It then remains disabled until OAT once again exceeds 70° F (21.1° C).
2. Night Flush Mode will be ON when all the following conditions are true:
 - a. Night Flush Enable is ENABLED as above.
 - b. OAT is less than Econ Enable Temp – 1° F (0.55° C).
 - c. Space Temp is greater than Occ Heating Setpt + Min Setpt Diff.
 - d. The time is between midnight and the first scheduled Occupied start time.
3. Night Flush Mode stops when any of the following conditions are true:
 - a. Night Flush Enable is DISABLED as above.
 - b. OAT is greater than Econ Enable Temp + 1° F (0.55° C).
 - c. Space Temp is less than Occ Heating Setpt + Min Setpt Diff / 2.
 - d. The time is greater than the first scheduled Occupied start time.

During Night Flush mode, Econ Mode is ENABLED and the fan is called for to run.

NOTE: To permanently disable the night flush option, write Inactive at priority 8 to BV40.

Ventilation Pre-Purge

If OA Purge (0% default) is greater than zero, during the 60 minutes prior to the first scheduled Occupied start time, the supply fan is called for to run and the OA damper is set to OA Purge.

Dehumidification

On FlexStat models with a humidity sensor, dehumidification is offered as an option. Once the dehumidification sequence is enabled through the user interface, the dehumidification mode starts if the space humidity rises above the dehum setpoint (adjustable, default 60%). The dehum mode is stopped if the space humidity drops below the dehum setpoint minus the dehum span (adjustable, default 5%). Dehumidification mode being started also generates a call for fan if the fan mode is set to "Auto."

Humidification (BAC-1x136 and BAC-1xx136 Only)

On BAC-1x136 and BAC-1xx136 models, humidification is offered as an option. Once the humidification sequence is enabled through the U/I, two other options are presented; humidifier valve type and an option to lockout the humidifier sequence under certain conditions.

If "allow clg hum" is set to "no," then the humidifier valve is automatically closed any time the FlexStat is operating in the cooling mode and allowed to follow the normal humidifier sequence if the FlexStat is in the heating mode.

If "allow clg hum" is set to "yes" (default selection), then the humidifier valve follows the normal humidification sequence whether the unit is in the heating or cooling mode.

If the humidifier valve is set to modulating, then the humidifier valve will generally start to open as the space humidity drops below the humidification setpoint and will modulate to fully open as the space humidity falls below the humidification setpoint minus the humidity span. Actual response may vary slightly due to PI action of the control loop.

If the humidifier valve is set to two-position, then the humidifier valve opens if the space humidity falls below the space humidity setpoint and closes if the space humidity rises above the space humidity setpoint plus the humidity span.

The humidifier valve closes any time the fan status is determined to be “off.”

Staged Heating and Cooling Parameters

On applications with staged heating and cooling, there will be a 3 minute (adjustable) delay between calls for stages (stage delay).

Once a stage of heating or cooling turns off, there is a 3 minute (adjustable) minimum off time before that stages output can be reenergized.

Once all stages of heating and cooling have turned off, the fan will remain energized for 3 minutes (adjustable, off delay).

User Interface Display Backlight

The user interface display backlight will illuminate any time any button is pushed on the FlexStat. It will remain illuminated for 60 seconds (adjustable). The display is also controllable from Control Basic programming.

BAC-1xx63/1xxx63 Applications

AHU (Air Handling Unit)

Fan Control

The fan follows the base sequence for fan operation as listed in the *Flex-Stat (All Models) Common Features* section above.

Valve Control

The method of controlling the heating and cooling valves is based on the fan configuration:

- **If the fan mode for a particular occupancy mode is set to constant or “On,” the valves function in a modulating fashion.** Actual response may vary slightly due to PI action of the control loops, but generally the heating valve will start to open as the space temperature drops below the active heating setpoint and modulate to fully open when space temperature reaches active heating setpoint minus heating proportional band. Likewise, the cooling valve will generally begin opening as the space temperature rises above the active cooling setpoint and be fully open by the time the space temp reaches the active cooling setpoint plus cooling proportional band, modulating linearly in between.
- **With the fan mode set to “Auto,” the heating valve will open 100% if the space temperature falls below active heating setpoint minus heating proportional band and fully close when space temp rises above active heating setpoint. The cooling valve similarly opens 100% if the space temp rises above the active cooling setpoint plus cooling proportional band and fully closes if the space temp falls below the active cooling setpoint.**

If at any time there is a low limit alarm, the cooling valve is forced closed and the heating valve opens fully.

If at any time there is a fan failure alarm, the cooling and heating valves are both forced closed.

Economizer Control

If the AHU application is configured for the economizer option, the economizer sequence described in the Common Features section is followed.

Dehumidification

If the dehumidification sequence is enabled on models BAC-1xx163C/1x163C, the dehumidification mode is started and stopped as described in the Common Features section. Upon activation of the dehumidification mode, the cooling valve is opened 100%. The heating valve then reheats the space as called for in a modified heating sequence to maintain the active cooling setpoint. Upon termination of the dehumidification mode, the valves return to their normal sequence.

An option is provided to prevent the FlexStat from going into dehumidification mode if it is presently operating in the heating mode. If the option “allow htg dehum” is set to “yes,” then dehumidification as described above can operate at any time. If the “allow htg dehum” option is set to “no,” then the dehumidification mode is allowed to operate normally if the FlexStat is presently cooling. If the “allow htg dehum” option is set to “no” and the FlexStat is presently heating, then the dehumidification mode is automatically stopped.

HPU (Heat Pump Unit)

Fan Control

The fan follows the base sequence for fan operation as listed above if the heat pump application is configured for one stage of compressor.

If the heat pump application is configured for two stages of compressor, the fan follows the base sequence for fan operation described in the Common Features section with the following exception. If the fan mode is set to “Auto,” the fan will start if the space temp rises above the active cooling setpoint plus one half the cooling proportional band and will stop if the space temp drops below the active cooling setpoint. If the space temp drops below the active heating setpoint minus one half the heating proportional band, the fan will start and stop when the fan rises above the active heating setpoint. This will allow only one stage of heating or cooling to run if necessary.

Fan off delays apply as previously described.

Reversing Valve

The reversing valve can be configured through the user interface to be energized on a call for heating (“B” function) or energized on a call for cooling (“O” function). If the reversing valve is configured to be **energized on a call for heating (“B”)**, the reversing valve output will be energized any time there is a call for heating and de-energized on a call for cooling. If the reversing valve is configured to be **energized on a call for cooling (“O”)**, the reversing valve output will be energized any time there is a call for cooling and de-energized on a call for heating.

Compressor Staging

The sequence for the compressor staging depends on the number of configured stages in the heat pump application:

- If the application is **configured for one compressor stage**, the following sequence is used. If the space temperature rises above the active cooling setpoint plus the cooling proportional band AND the compressor has been off at least the minimum off time, the compressor is energized. If the space temp drops below the active cooling setpoint, the compressor is de-energized. If the space temp drops below the active heating setpoint minus the heating proportional band AND the compressor has been off the minimum off time, the compressor will be energized. If the space temp rises above the active heating setpoint, the compressor is de-energized.
- If the application is **configured for two compressor stages**, the following sequence is used. In the heating mode, if the space temperature drops below the active heating setpoint minus one half the heating proportional band AND the first stage of compressor has been off for at least the minimum off time, the first stage of compressor will be energized. If the space temp further drops below the active heating setpoint minus the heating proportional band AND the first stage of compressor has been energized for at least the stage delay AND the second stage of compressor has been off for at least the minimum off time, the second stage of compressor will be energized. Upon rise in

temperature above the active heating setpoint minus one half the heating proportional band, the second stage of compressor will be de-energized. Upon further rise in temperature above the active heating setpoint, the first stage of compressor will be de-energized. In the cooling mode, if the space temp rises above the active cooling setpoint plus one half the cooling proportional band AND the first stage of compressor has been off for at least the minimum off time, the first stage of compressor will be energized. If the space temp further rises above the active cooling setpoint plus the cooling proportional band AND the first stage of compressor has been energized for at least the stage delay AND the second stage of compressor has been off for at least the minimum off time, the second stage of compressor will be energized. Upon decrease in space temp below the active cooling setpoint plus one half the cooling proportional band, the second stage of compressor shall be de-energized. Upon further decrease in space temp below the active cooling setpoint, the first stage of compressor shall be de-energized.

If at any time there is a fan failure alarm or low limit alarm, all compressor stages are de-energized.

Auxiliary/Emergency Heat

The heat pump application can be configured with auxiliary heat in three methods: no auxiliary heat, auxiliary heat with outside air temp compressor lockout, and auxiliary heat without outside air temp compressor lockout.

If the unit is **configured for auxiliary heat without compressor lockout**, the auxiliary heat and emergency heat function as third and fourth stages of heat. If the space temperature drops below the active heating setpoint minus 1.5 times the heating proportional band and remains below that temperature for the Auxiliary Heat Delay (adjustable), the auxiliary heat is energized. If the space temperature further falls below the active heating setpoint minus 2 times heating proportional band and the auxiliary heat is energized, the emergency heat is then energized. If the space temperature rises above the active heating setpoint minus 1.5 times heating proportional band, the emergency heat is de-energized. If the space temp further rises above the active heating setpoint minus the heating proportional band, the auxiliary heat is de-energized.

If the heat pump application is configured for auxiliary heat with compressor lockout, a compressor lockout mode is enabled if the outside air temperature drops 1.0° F (0.56° C) below the Compressor OAT Low Limit. The compressor lockout mode is disabled if the outside air temperature rises 1.0° F (0.56° C) above the Compressor OAT Low Limit. If the compressor lockout mode is disabled, the auxiliary and emergency heat function as described above. If the compressor lockout mode is enabled, all stages of compressor are de-energized and the auxiliary and emergency heat function as described above but without the Auxiliary Heat Delay.

If the **System Mode** is set to “**Emer Ht**,” the compressors are locked out and the auxiliary and emergency heat stage operate as follows:

If the space temp drops below the active heating setpoint minus one half the heating proportional band, the auxiliary heat is energized. If the space temp further falls below the active heating setpoint minus the heating proportional band AND the auxiliary heat has been energized for at least the stage delay, the emergency heat is energized. Upon rise in temperature above the active heating setpoint minus one half the heating proportional band, the emergency heat will be de-energized. Upon further rise in temperature above the active heating setpoint, the auxiliary heat will be de-energized.

Any time there is a fan failure alarm or low limit alarm, auxiliary and emergency heating are de-energized.

Economizer Control

If the HPU application is configured for the economizer option, the base economizer sequence described in the Common Features section is followed.

Dehumidification

Upon activation of the dehumidification mode, configured stages of compressor are energized after they have been off for at least the minimum off time. The reversing valve is set to the cooling mode based on the reversing valve configuration. Auxiliary and emergency heating stages then follow their normal sequence to maintain the active heating setpoint.

FCU (Fan Coil Unit), 2-Pipe

Fan Control

The fan follows the base sequence for fan operation as listed in the *Flex-Stat (All Models) Common Features* section above with the following modifications.

When the fan runs, whether in “Auto” or “On” mode, the fan speed is determined by the Fixed Speed setting. If the Fixed Speed setting is set to a particular speed (“1,” “2,” or “3”), then any time the fan is called for, it will run at that speed. This allows fan speed to be set by a balancer. If the Fixed Speed is set to “Auto” and the Fan Mode is set to “On,” then the speed the fan runs is determined by the heating or cooling PI loops. The fan is started at low speed upon call for heating or cooling and remains there until the active heating or cooling PI loop reaches 60%. Once above 60%, the fan is incrementally sped up based on the upper 40% of the heating or cooling PI loop, whichever is active based on the number of fan stages configured. The fan slows down in the reverse sequence. This operation allows the FCU to attempt to maintain space temperature setpoint using the valve at low fan speed. If space temp setpoint cannot be maintained at low speed, increasing the fan speed will allow more heat transfer to/from the coil. If the Fixed Speed is set to “Auto” and the Fan Mode is set to “Auto,” then when the fan is called for, it runs on the highest speed for which the unit is configured.

Water Valve Operation and H/C Water Available Determination

The application is capable of determining whether heating or cooling water is available even in a stand-alone configuration. If the FlexStat has a call for heating or cooling greater than 10% and the unit does not know what type of water is available (the valve is fully closed), the FlexStat will initiate a **water evaluation mode**. During the water evaluation mode, all fan outputs are de-energized and the water valve opens for three minutes. After three minutes, the valve closes and a water temperature reading is immediately taken. If the water temp is below 63° F (17.2° C), a chilled water available flag is started. If the water temp is above 90° F (32.2° C), a heating water available flag is started. These flags will stay on until the valve goes fully shut for ten minutes (or as set in **min eval timer**) or the water drops 2.0° (1.1° C) out of range. If the opposite type of water is available from what type of water is needed (e.g.,

cooling water is available and there is a call for heating), another flag indicating opposite water available is started. If the unit goes into “opposite water available” mode and the unit remains calling for the same temperature mode (heating or cooling), every fifteen minutes (or as set in **opposite water timer**) the unit will reinitiate the water evaluation mode. If neither heating nor cooling water is available, the water evaluation mode is run every ten minutes (or as set in **min eval timer**).

NOTE: If adjusted, **min eval timer** should always be set at least 30 seconds lower than **opposite water timer** and is limited in programming to be so.

The method of controlling the valve is based on the fan configuration as well as the valve configuration:

- For a **modulating valve configuration**, if the fan mode for a particular occupancy mode is set to constant or “On,” the valve functions in a modulating fashion. Actual response may vary slightly due to PI action of the control loops, but generally, if heating water is available, the valve will start to open as the space temperature drops below the active heating setpoint and modulate to fully open when space temperature reaches active heating setpoint minus heating proportional band. The valve modulates closed as the space temp rises towards the active heating setpoint. Likewise, the valve will generally begin opening as the space temperature rises above the active cooling setpoint and be fully open by the time the space temp reaches the active cooling setpoint plus cooling proportional band, modulating linearly in between. Once the valve closes fully in either heating or cooling mode, all water available flags are turned off.
- For a **two-position valve configuration**, with the fan mode set to “Auto,” the valve will open 100% if the space temperature falls below active heating setpoint minus heating proportional band and fully close when space temp rises above active heating setpoint if heating water is available. The valve similarly opens 100% if the space temp rises above the active cooling setpoint plus cooling proportional band and fully closes if the space temp falls below the active cooling setpoint if cooling water is available.

Any time there is a fan failure alarm, the valve will be fully closed.

FCU (Fan Coil Unit), 4-Pipe

Fan Control

The fan follows the base sequence for fan operation as listed in the *Flex-Stat (All Models) Common Features* section above with the following modifications.

When the fan runs, whether in “Auto” or “On” mode, the fan speed is determined by the Fixed Speed setting. If the Fixed Speed setting is set to a particular speed (“1,” “2,” or “3”), then any time the fan is called for, it will run at that speed. This allows fan speed to be set by a balancer. If the Fixed Speed is set to “Auto” and the Fan Mode is set to “On,” then the speed the fan runs is determined by the heating or cooling PI loops. The fan is started at low speed upon call for heating or cooling and remains there until the active heating or cooling PI loop reaches 60%. Once above 60%, the fan is incrementally sped up based on the upper 40% of the heating or cooling PI loop, whichever is active based on the number of fan stages configured. The fan slows down in the reverse sequence. This operation allows the FCU to attempt to maintain space temperature setpoint using the valve at low fan speed. If space temp setpoint cannot be maintained at low speed, increasing the fan speed will allow more heat transfer to/from the coil. If the Fixed Speed is set to “Auto” and the Fan Mode is set to “Auto,” then when the fan is called for, it runs on the highest speed for which the unit is configured.

Valve Control

The method of controlling the heating and cooling valves is based on the fan configuration as well as the valve configuration:

- **If the valves are configured for modulating action and the fan mode for a particular occupancy mode is set to constant or “On,”** the valves function in a modulating fashion. Actual response may vary slightly due to PI action of the control loops, but generally, the heating valve will start to open as the space temperature drops below the active heating setpoint and modulate to fully open when space temperature reaches active heating setpoint minus heating proportional band. Likewise, the cooling valve will generally begin opening as the space temperature rises above the active cooling setpoint and be fully open by the time the space temp reaches the active cooling setpoint plus cooling proportional band, modulating linearly in between.
- **With the fan mode set to “Auto” or the valves are configured for two-position operation,** the heating valve will open 100% if the space temperature falls below active heating setpoint minus heating proportional band and fully close when space temp rises above active heating setpoint. The cooling valve similarly opens 100% if the space temp rises above the active cooling setpoint plus cooling proportional band and fully closes if the space temp falls below the active cooling setpoint.

If at any time there is a fan failure alarm, the cooling and heating valves are both forced closed.

Dehumidification

If the dehumidification sequence is enabled on models BAC-10163C/11163C, the dehumidification mode is started and stopped as described in the Common Features section above. Upon activation of the dehumidification mode, the cooling valve is opened 100%. The heating valve then reheats the space as called for in a modified heating sequence to maintain the active cooling setpoint. Upon termination of the dehumidification mode, the valves return to their normal sequence.

RTU (Roof Top Unit)

Fan Control

The fan follows the base sequence for fan operation as listed in the *Flex-Stat (All Models) Common Features* section above with the following modifications.

If the fan mode is set to “Auto,” the fan will start if the space temp rises above the active cooling setpoint plus one half the cooling proportional band and will stop if the space temp drops below the active cooling setpoint. If the space temp drops below the active heating setpoint minus one half the heating proportional band, the fan will start and stop when the fan rises above the active heating setpoint. This will allow only one stage of heating or cooling to run if necessary.

Fan off delays apply as previously described.

Heating/Cooling Staging

In the heating mode, if the space temperature drops below the active heating setpoint minus one half the heating proportional band, the first stage of heating will be energized. If the space temp further drops below the active heating setpoint minus the heating proportional band AND the first stage of heating has been energized for at least the stage delay, the second stage of heating will be energized. Upon rise in temperature above the active heating setpoint minus one half the heating proportional band, the second stage of heating will be de-energized. Upon further rise in temperature above the active heating setpoint, the first stage of heating will be de-energized.

In the cooling mode, if the space temp rises above the active cooling setpoint plus one half the cooling proportional band AND the first stage of cooling has been off for at least the minimum off time, the first stage of cooling will be energized. If the space temp further rises above the active

cooling setpoint plus the cooling proportional band AND the first stage of cooling has been energized for at least the stage delay AND the second stage of cooling has been off for at least the minimum off time, the second stage of cooling will be energized. Upon decrease in space temp below the active cooling setpoint plus one half the cooling proportional band, the second stage of cooling shall be de-energized. Upon further decrease in space temp below the active cooling setpoint, the first stage of cooling shall be de-energized.

If the economizer option is set to modulating economizer and the economizer mode is enabled, the stages of cooling will be held off until the outside air damper is 100% open. When the outside air damper is fully open, normal staging of cooling is allowed. If the economizer option is set to “Econ Dis/En” and the economizer mode is enabled, cooling is allowed to stage normally.

If at any time there is a fan failure alarm or a low limit alarm, all stages of heating and cooling are stopped at priority 5, bypassing any minimum on times (minimum on times added by others, not part of the base sequence).

Economizer Control

If the RTU application is configured for the modulating economizer option, the above economizer sequence is followed. If the application is configured for econ disable/enable, the economizer mode is determined as above. Any time the econ mode is enabled, the econ dis/en output is energized. If the econ mode is disabled, the econ dis/en output is de-energized.

Dehumidification

Upon activation of the dehumidification mode, both stages of cooling are energized after they have been off for at least the minimum off time. Heating stages then follow their normal sequence to maintain the active heating setpoint.

BAC-1xx36/1xxx36 Series (3 Relays and 6 Analog Outputs)

This section is specific to the BAC-1xx36/1xxx36 series (with 6 relays and 3 analog outputs). **Model numbers with the additional digit** (BAC-12xxxx, 13xxxx, and BAC-14xxxx) **have three additional inputs and options for CO₂ sensing** (BAC-13xxxx and BAC-14xxxx) **and IP network connections** (BAC-1xxxxxE).

NOTE: See also the [FlexStat Catalog Supplement and Selection Guide \(SP-091\)](#).

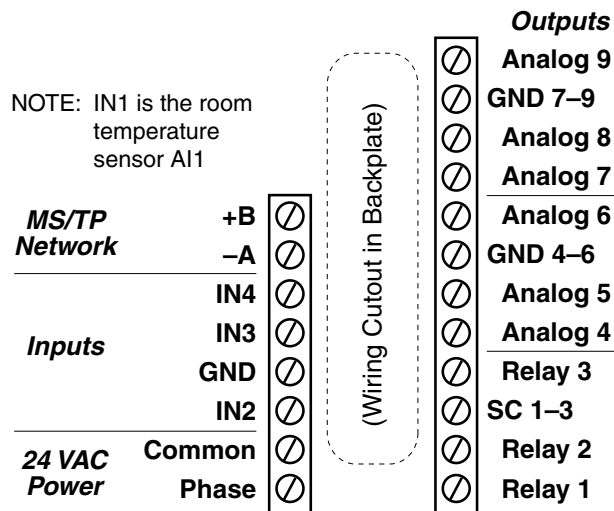

BAC-1xx36 Terminals

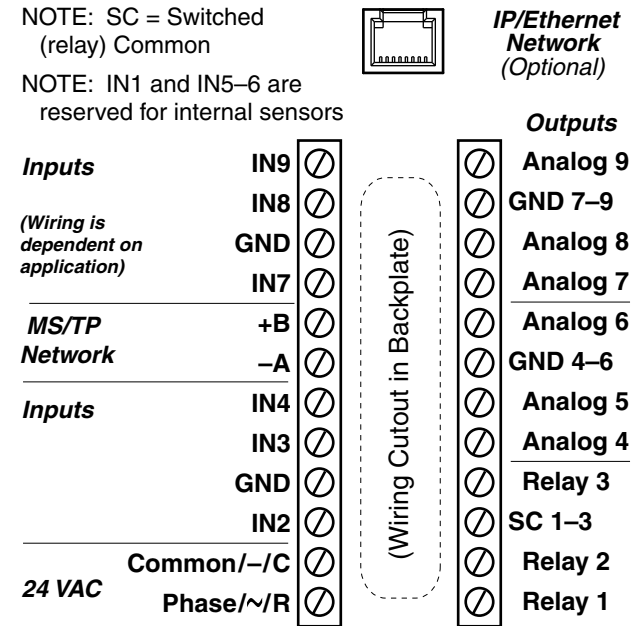

BAC-12xx36 Terminals (BAC-13xx36/14xx36 Terminals Are Rotated 90°)

Bills of Materials (BAC-1xx36/1xxx36)

AHU (Air Handling Unit)—Multiple H/C Options

BILL OF MATERIALS: AHU, 1 Heat and 1 Cool		
REFERENCE	KMC PART #	PART DESCRIPTION
FLEXSTAT	BAC-1xx36/ 1xxx36	BACNET THERMOSTAT, 6 RELAY & 3 ANALOG OUTPUTS
R1	REE-3211	MULTI-VOLTAGE CONTROL RELAY, 1.2 VA
HUMV	VEB-43xxxBDL	FAIL-SAFE CONTROL VALVE, W/ MEP-5372 2-10VDC ACTUATOR, 19 VA
FOR VALVE, CHOOSE CAPACITY/MODEL FROM KMC DATA SHEET		
HUM	REE-3112	12/24 VDC CONTROL RELAY, SPDT
DAT	STE-1402	DUCT TEMPERATURE SENSOR
FST	CSE-1102	AIR DIFFERENTIAL PRESSURE SWITCH, 0.05-12" WC
MAT	STE-1416	12' DUCT AVERAGING TEMP SENSOR
OAT	STE-1451	OUTSIDE TEMPERATURE SENSOR
*	STE-6011	REMOTE TEMPERATURE SENSOR, TYPE II
*	SAE-10xx	REMOTE CO ₂ SENSOR, SPACE OR DUCT
TX1	XEE-6311-050	TRANSFORMER, 120/240/277/480:24 VAC, 50 VA
CHOOSE ONE OF THE FOLLOWING TRANSFORMERS:		
TX2	XEE-6311-075	TRANSFORMER, 120/208/240/480:24 VAC, 75 VA
TX2	XEE-6311-100	TRANSFORMER, 120/240/277/480:24 VAC, 96 VA
<i>*The remote temperature and CO₂ sensor options are not shown in the sample installation diagrams, and they are available only on BAC-12xxxx/13xxxx/14xxxx models.</i>		

BILL OF MATERIALS: AHU, DAMPER ACTUATORS			
REFERENCE	MAX DAMPER AREA IN FT ²	KMC PART #	PART DESCRIPTION
OAD or RTD	6.25	MEP-5372	50 IN·LB FAIL-SAFE ACTUATOR, 2-10VDC, 19VA
OAD or RTD	15	MEP-7252	120 IN·LB FAIL-SAFE ACTUATOR, 0-10VDC, 25VA
OAD or RTD	22.5	MEP-7552	180 IN·LB FAIL-SAFE ACTUATOR, 0-10VDC, 25VA
OAD or RTD	40	MEP-7852	320 IN·LB FAIL-SAFE ACTUATOR, 0-10VDC, 40VA

NOTE: See the corresponding [BAC-1xx36](#) or [BAC-1xxx36](#) Installation Guide section for detailed drawings and input/output connections as well as other important installation information.

NOTE: Remote temperature and CO₂ sensors are available only on BAC-12xxxx/13xxxx/14xxxx models. When IN7 is configured for a remote space temperature sensor, space temperature can be configured for onboard, remote, averaging of the two, the lowest reading, or the highest reading. When DCV is enabled in the BAC-12xxxx (without a built-in CO₂ sensor), IN9 is assumed to be connected to an external SAE-10xx CO₂ sensor. BAC-13xxxx/14xxxx FlexStats also have the external CO₂ sensor option, and if used, the highest of the two readings (internal vs. external) will be used to control DCV sequences. See the [FlexStat Operation Guide](#) for more details.

NOTE: Humidity and motion/occupancy sensor options are dependent on FlexStat model.

NOTE: See also [Sequence of Operation \(BAC-1xx36/1xxx36\)](#) on page 57.

NOTE: Do not use REE-3211 relays with **analog** outputs! See [Connecting Outputs](#) on page 13.

BILL OF MATERIALS: AHU, 1 or 2 Heat and Modulating Cool		
REFERENCE	KMC PART #	PART DESCRIPTION
FLEXSTAT	BAC-1xx36/ 1xxx36	BACNET THERMOSTAT, 6 RELAY & 3 ANALOG OUTPUTS
R1	REE-3211	MULTI-VOLTAGE CONTROL RELAY, 1.2 VA
CLV	VEB-43xxxBDL	FAIL-SAFE CONTROL VALVE, W/ MEP-5372 2-10 VDC ACTUATOR, 19 VA
HUMV		
FOR VALVES, CHOOSE CAPACITY/MODEL FROM KMC DATA SHEET		
HUM	REE-3112	12/24 VDC CONTROL RELAY, SPDT
DAT	STE-1402	DUCT TEMPERATURE SENSOR
FST	CSE-1102	AIR DIFFERENTIAL PRESSURE SWITCH, 0.05-12" WC
MAT	STE-1416	12' DUCT AVERAGING TEMP SENSOR
OAT	STE-1451	OUTSIDE TEMPERATURE SENSOR
*	STE-6011	REMOTE TEMPERATURE SENSOR, TYPE II
*	SAE-10xx	REMOTE CO ₂ SENSOR, SPACE OR DUCT
TX1	XEE-6311-050	TRANSFORMER, 120/240/277/480:24 VAC, 50 VA
CHOOSE ONE OF THE FOLLOWING TRANSFORMERS:		
TX2	XEE-6311-075	TRANSFORMER, 120/208/240/480:24 VAC, 75 VA
TX2	XEE-6311-100	TRANSFORMER, 120/240/277/480:24 VAC, 96 VA
<i>*The remote temperature and CO₂ sensor options are not shown in the sample installation diagrams, and they are available only on BAC-12xxxx/13xxxx/14xxxx models.</i>		

BILL OF MATERIALS: AHU, Modulating Heat and 1 or 2 Cool		
REFERENCE	KMC PART #	PART DESCRIPTION
FLEXSTAT	BAC-1xx36/ 1xxx36	BACNET THERMOSTAT, 6 RELAY & 3 ANALOG OUTPUTS
R1	REE-3211	MULTI-VOLTAGE CONTROL RELAY, 1.2 VA
HTV	VEB-43xxxBDL	FAIL-SAFE CONTROL VALVE, W/ MEP-5372 2-10 VDC ACTUATOR, 19 VA
HUMV		
FOR VALVES, CHOOSE CAPACITY/MODEL FROM KMC DATA SHEET		
HUM	REE-3112	12/24 VDC CONTROL RELAY, SPDT
DAT	STE-1402	DUCT TEMPERATURE SENSOR
FST	CSE-1102	AIR DIFFERENTIAL PRESSURE SWITCH, 0.05-12" WC
MAT	STE-1416	12' DUCT AVERAGING TEMP SENSOR
OAT	STE-1451	OUTSIDE TEMPERATURE SENSOR
*	STE-6011	REMOTE TEMPERATURE SENSOR, TYPE II
*	SAE-10xx	REMOTE CO ₂ SENSOR, SPACE OR DUCT
TX1	XEE-6311-075	TRANSFORMER, 120/240/277/480:24 VAC, 75 VA
CHOOSE ONE OF THE FOLLOWING TRANSFORMERS:		
TX2	XEE-6311-075	TRANSFORMER, 120/208/240/480:24 VAC, 75 VA
TX2	XEE-6311-100	TRANSFORMER, 120/240/277/480:24 VAC, 96 VA
<i>*The remote temperature and CO₂ sensor options are not shown in the sample installation diagrams, and they are available only on BAC-12xxxx/13xxxx/14xxxx models.</i>		

BILL OF MATERIALS: AHU, DAMPER ACTUATORS			
REFERENCE	MAX DAMPER AREA IN FT ²	KMC PART #	PART DESCRIPTION
OAD or RTD	6.25	MEP-5372	50 IN·LB FAIL-SAFE ACTUATOR, 2-10VDC, 19VA
OAD or RTD	15	MEP-7252	120 IN·LB FAIL-SAFE ACTUATOR, 0-10VDC, 25VA
OAD or RTD	22.5	MEP-7552	180 IN·LB FAIL-SAFE ACTUATOR, 0-10VDC, 25VA
OAD or RTD	40	MEP-7852	320 IN·LB FAIL-SAFE ACTUATOR, 0-10VDC, 40VA

BILL OF MATERIALS: AHU, DAMPER ACTUATORS			
REFERENCE	MAX DAMPER AREA IN FT ²	KMC PART #	PART DESCRIPTION
OAD or RTD	6.25	MEP-5372	50 IN·LB FAIL-SAFE ACTUATOR, 2-10VDC, 19VA
OAD or RTD	15	MEP-7252	120 IN·LB FAIL-SAFE ACTUATOR, 0-10VDC, 25VA
OAD or RTD	22.5	MEP-7552	180 IN·LB FAIL-SAFE ACTUATOR, 0-10VDC, 25VA
OAD or RTD	40	MEP-7852	320 IN·LB FAIL-SAFE ACTUATOR, 0-10VDC, 40VA

BILL OF MATERIALS: AHU, Modulating Heat and Modulating Cool		
REFERENCE	KMC PART #	PART DESCRIPTION
FLEXSTAT	BAC-1xx36/ 1xxx36	BACNET THERMOSTAT, 6 RELAY & 3 ANALOG OUTPUTS
R1	REE-3211	MULTI-VOLTAGE CONTROL RELAY, 1.2 VA
CLV	VEB-43xxxBDL	FAIL-SAFE CONTROL VALVE, W/ MEP-5372 2-10VDC ACTUATOR, 19 VA
HTV		
FOR VALVES, CHOOSE CAPACITY/MODEL FROM KMC DATA SHEET		
HUM	REE-3112	12/24 VDC CONTROL RELAY, SPDT
DAT	STE-1402	DUCT TEMPERATURE SENSOR
FST	CSE-1102	AIR DIFFERENTIAL PRESSURE SWITCH, 0.05-12" WC
MAT	STE-1416	12' DUCT AVERAGING TEMP SENSOR
OAT	STE-1451	OUTSIDE TEMPERATURE SENSOR
*	STE-6011	REMOTE TEMPERATURE SENSOR, TYPE II
*	SAE-10xx	REMOTE CO ₂ SENSOR, SPACE OR DUCT
TX1	XEE-6311-075	TRANSFORMER, 120/240/277/480:24 VAC, 75 VA
CHOOSE ONE OF THE FOLLOWING TRANSFORMERS:		
TX2	XEE-6311-075	TRANSFORMER, 120/208/240/480:24 VAC, 75 VA
TX2	XEE-6311-100	TRANSFORMER, 120/240/277/480:24 VAC, 96 VA
<i>*The remote temperature and CO₂ sensor options are not shown in the sample installation diagrams, and they are available only on BAC-12xxxx/13xxxx/14xxxx models.</i>		

BILL OF MATERIALS: AHU, DAMPER ACTUATORS			
REFERENCE	MAX DAMPER AREA IN FT ²	KMC PART #	PART DESCRIPTION
OAD or RTD	6.25	MEP-5372	50 IN·LB FAIL-SAFE ACTUATOR, 2-10VDC, 19VA
OAD or RTD	15	MEP-7252	120 IN·LB FAIL-SAFE ACTUATOR, 0-10VDC, 25VA
OAD or RTD	22.5	MEP-7552	180 IN·LB FAIL-SAFE ACTUATOR, 0-10VDC, 25VA
OAD or RTD	40	MEP-7852	320 IN·LB FAIL-SAFE ACTUATOR, 0-10VDC, 40VA

FCU (Fan Coil Unit)—2 or 4 Pipe, Modulating

BILL OF MATERIALS: FCU, 2-Pipe, Modulating		
REFERENCE	KMC PART #	PART DESCRIPTION
FLEXSTAT	BAC-1xx36/ 1xxx36	BACNET THERMOSTAT, 6 RELAY & 3 ANALOG OUTPUTS
R1, R2, R3	REE-3211	MULTI-VOLTAGE CONTROL RELAY, 1.2 VA
VLV	VEB-43xxxBCK	CONTROL VALVE W/ MEP-4002 0-10V ACTUATOR, 4 VA
FOR VALVE, CHOOSE CAPACITY/MODEL FROM KMC DATA SHEET		
DAT	STE-1402	DUCT TEMPERATURE SENSOR
FST	CSE-1102	AIR DIFFERENTIAL PRESSURE SWITCH, 0.05-12" WC
W-TMP	STE-1454/1455	2" STRAP-ON TEMPERATURE SENSOR (w/ or w/o enclosure)
*	STE-6011	REMOTE TEMPERATURE SENSOR, TYPE II
TX	XEE-6311-050	TRANSFORMER, 120/240/277/480:24 VAC, 50 VA
<i>*The remote temperature sensor option is not shown in the sample installation diagrams, and it is available only on BAC-12xxxx/13xxxx/14xxxx models.</i>		

BILL OF MATERIALS: FCU, 4-Pipe, Modulating		
REFERENCE	KMC PART #	PART DESCRIPTION
FLEXSTAT	BAC-1xx63/ 1xxx63	BACNET THERMOSTAT, 6 RELAY & 3 ANALOG OUTPUTS
R1, R2, R3	REE-3211	MULTI-VOLTAGE CONTROL RELAY, 1.2 VA
CLV	VEB-43xxxBCK	CONTROL VALVE W/ MEP-4002 0-10V ACTUATOR, 4 VA
HTV		
HUMV	VEB-43xxxBDL	FAIL-SAFE CONTROL VALVE, W/ MEP-5372 2-10VDC ACTUATOR, 19 VA
FOR VALVES, CHOOSE CAPACITY/MODEL FROM KMC DATA SHEET		
HUM	REE-3112	12/24 VDC CONTROL RELAY, SPDT
DAT	STE-1402	DUCT TEMPERATURE SENSOR
FST	CSE-1102	AIR DIFFERENTIAL PRESSURE SWITCH, 0.05-12" WC
*	STE-6011	REMOTE TEMPERATURE SENSOR, TYPE II
TX	XEE-6311-050	TRANSFORMER, 120/240/277/480:24 VAC, 50 VA
<i>*The remote temperature sensor option is not shown in the sample installation diagrams, and it is available only on BAC-12xxxx/13xxxx/14xxxx models.</i>		

Sequence of Operation (BAC-1xx36/1xxx36)

NOTE: This information reflects firmware version R2.0.0.13 or later (but specifications are subject to change).

BAC-1xx36/1xxx36 Common Features

For common features, see *FlexStat (All Models) Common Features on page 38*.

BAC-1xx36/1xxx36 Series Applications

AHU (Air Handling Unit)

Fan Control

The fan follows the base sequence for fan operation as listed in the *FlexStat (All Models) Common Features* section with the following modifications.

Modulating/One Stage—The fan will start if the space temp rises above the active cooling setpoint plus the cooling proportional band and will stop if the space temp drops below the active cooling setpoint. If the space temp drops below the active heating setpoint minus the heating proportional band, the fan will start and will stop when the fan rises above the active heating setpoint.

Two Stages—The fan will start if the space temp rises above the active cooling setpoint plus one half the cooling proportional band and will stop if the space temp drops below the active cooling setpoint. If the space temp drops below the active heating setpoint minus one half the heating proportional band, the fan will start and will stop when the fan rises above the active heating setpoint. This will allow one of the two stages of heating or cooling to run by itself before staging on the second stage.

Fan off delays apply as described in Staged Heating and Cooling.

Fan Speed Control

Fan speed is controlled by the Fan Control Type (Speeds) setting. If the fan control type is set to “constant,” then the fan speed output is not used.

If the fan control type is set to “variable,” then the following sequence applies. When the fan runs, whether in “Auto” or “On” mode, the fan speed is determined by the Output Speed setting. If the Output Speed setting is set to “fixed,” then any time the fan is called for, it will run at the speed designated by the Fixed Speed setting. This allows for the fan speed to be manually set by a balancer.

If the Output Speed is set to “Auto,” then the speed the fan runs is determined by both the fan mode (auto/on) and the heating or cooling PI loops.

If the current fan mode is set to “auto,” the fan cycles at 100% speed. If the current fan mode is set to “on,” the fan is started at minimum speed upon call for heating or cooling and remains there until the active heating or cooling PI loop reaches 60%. Once above 60%, the fan is modulated up to 100% based on the upper 40% of the heating or cooling PI loop, whichever is active. The fan slows down in the reverse sequence. This operation allows the AHU to attempt to maintain space temperature setpoint using the valve at minimum fan speed. If space temp setpoint cannot be maintained at minimum speed, increasing the fan speed will allow more heat transfer to/from the coil.

Valve Control (If Configured)

The method of controlling the heating and cooling valves is based on the fan configuration:

- **If the fan mode for a particular occupancy mode is set to constant or “On,” the valves function in a modulating fashion.** Actual response may vary slightly due to PI action of the control loops, but generally the heating valve will start to open as the space temperature drops below the active heating setpoint and modulate to fully open when space temperature reaches active heating setpoint minus heating proportional band. Likewise, the cooling valve will generally begin opening as the space temperature rises above the active cooling setpoint and be fully open by the time the space temp reaches the active cooling setpoint plus cooling proportional band, modulating linearly in between.

- **With the fan mode set to “Auto,” the heating valve will open 100%** if the space temperature falls below active heating setpoint minus heating proportional band and fully close when space temp rises above active heating setpoint. The cooling valve similarly opens 100% if the space temp rises above the active cooling setpoint plus cooling proportional band and fully closes if the space temp falls below the active cooling setpoint.

If at any time there is a low limit alarm, the cooling valve is forced closed and the heating valve opens fully.

If at any time there is a fan failure alarm, the cooling and heating valves are both forced closed.

Staged Heating and Cooling Parameters

On applications with staged heating and cooling, there will be a 3 minute (adjustable) delay between calls for stages (stage delay). Once a stage of heating or cooling turns off, there is a 3 minute (adjustable) minimum off time before that stage’s output can be reenergized. Once all stages of heating and cooling have turned off, the fan will remain energized for 3 minutes (adjustable, off delay).

One Heating Stage

If the space temperature drops below the active heating setpoint minus the heating proportional band AND the first stage of heating has been off for at least the minimum off time, the first stage of heating will be energized. Upon rise in temperature above the active heating setpoint, the first stage of heating will be deenergized.

Two Heating Stages

If the space temperature drops below the active heating setpoint minus one half the heating proportional band AND the first stage of heating has been off for at least the minimum off time, the first stage of heating will be energized. If the space temp further drops below the active heating setpoint minus the heating proportional band AND the first stage of heating has been energized for at least the stage delay AND the second stage of heating has been off for at least the minimum off time, the second stage of heating will be energized. Upon rise in temperature above the active heating setpoint minus one half the heating proportional

band, the second stage of heating will be deenergized. Upon further rise in temperature above the active heating setpoint, the first stage of heating will be deenergized.

Staged Cooling

If the economizer option is set to modulating economizer and the economizer mode is enabled, the stage(s) of cooling will be held off until the outside air damper is 100% open. When the outside air damper is fully open, normal staging of cooling is allowed. If the economizer option is set to “Econ Dis/En” and the economizer mode is enabled, cooling is allowed to stage normally.

If at any time there is a fan failure alarm or a low limit alarm, all stages of heating and cooling are stopped at priority 5 bypassing any minimum on times (minimum on times added by others, not part of the base sequence).

One Cooling Stage

If the space temp rises above the active cooling setpoint plus the cooling proportional band AND the first stage of cooling has been off for at least the minimum off time, the first stage of cooling will be energized. Upon decrease in space temp below the active cooling setpoint, the first stage of cooling shall be deenergized.

Two Cooling Stages

If the space temp rises above the active cooling setpoint plus one half the cooling proportional band AND the first stage of cooling has been off for at least the minimum off time, the first stage of cooling will be energized. If the space temp further rises above the active cooling setpoint plus the cooling proportional band AND the first stage of cooling has been energized for at least the stage delay AND the second stage of cooling has been off for at least the minimum off time, the second stage of cooling will be energized. Upon decrease in space temp below the active cooling setpoint plus one half the cooling proportional band, the second stage of cooling shall be deenergized. Upon further decrease in space temp below the active cooling setpoint, the first stage of cooling shall be deenergized.

If at any time there is a low limit or fan fail alarm, all stages of cooling and heating are deenergized.

Economizer Control

If the economizer option is enabled, the economizer mode is determined by comparing **outside air temperature (OAT)** to the economizer enable temperature. The economizer mode is enabled if the OAT is 1.0° F (0.56° C) below the economizer enable temperature and disabled if the OAT is 1.0° F (0.56° C) above the econ enable temp.

If the application is configured for econ enable/disable, the economizer mode is determined as above. Any time the econ mode is enabled, the econ output is energized at 100% (12vdc). If the econ mode is disabled, the econ output is deenergized.

If the application is configured for modulating operation, the following sequence is used:

During occupied mode, if the economizer mode is enabled, the OA damper will open to the greater of the minimum damper position setting (adjustable, for ventilation) or the mixed air temperature PI loop. The mixed air temp loop will modulate from 0% to 100% as the mixed air temp rises above the mixed air temp setpoint.

During occupied mode, the mixed air temp setpoint is determined based on a reset schedule. If the space temperature is at or below the active cooling setpoint, the mixed air temp setpoint is 68.0° F (20.0° C). If the space temperature is 2.0° F (1.1° C) above the active cooling setpoint, the mixed air temp setpoint will be 53.0° F (11.7° C). The mixed air setpoint will vary linearly in between.

During unoccupied mode, if the space temp exceeds the cooling setback setpoint by cooling proportional band and the econ mode is enabled, the OA damper shall open as called for by the mixed air temp loop. The

OA damper shall modulate to maintain 53.0° F (11.7° C) until the space temp reaches the cooling setback setpoint at which point it shall close. If at any time during unoccupied mode the economizer mode is disabled based on OAT, the outside air damper will close.

If the system mode is set to “heating” during occupied mode, the damper will open to minimum position when the fan is on. If the system mode is set to “heating” during unoccupied mode or is set to “off” in any occupancy mode, the outside damper will close. If at any time there is a fan alarm, the OA damper shall shut.

If the mixed air temp drops below the low limit alarm temp, a low limit alarm is generated and the outside air damper will close. Other safety actions are taken and described in their respective sections of the sequence.

Dehumidification

If the dehumidification sequence is enabled on models BAC-10136C/11136C, the dehumidification mode is started and stopped as described in the Common Features section. Upon activation of the dehumidification mode, the cooling valve is opened 100%. The heating valve then reheats the space as called for in a modified heating sequence to maintain the active cooling setpoint. Upon termination of the dehumidification mode, the valves return to their normal sequence.

FCU (Fan Coil Unit), 2-Pipe

Fan Control

The fan follows the base sequence for fan operation as listed in the *Flex-Stat (All Models) Common Features* section above with the following modifications.

When the fan runs, whether in “Auto” or “On” mode, the fan speed is determined by the Fixed Speed setting. If the Fixed Speed setting is set to a particular speed (“1,” “2,” or “3”), then any time the fan is called for, it will run at that speed. This allows fan speed to be set by a balancer. If the Fixed Speed is set to “Auto” and the Fan Mode is set to “On,” then the speed the fan runs is determined by the heating or cooling PI loops. The fan is started at low speed upon call for heating or cooling and remains there until the active heating or cooling PI loop reaches 60%. Once above 60%, the fan is incrementally sped up based on the upper 40% of the heating or cooling PI loop, whichever is active based on the number of fan stages configured. The fan slows down in the reverse sequence. This operation allows the FCU to attempt to maintain space temperature setpoint using the valve at low fan speed. If space temp setpoint cannot be maintained at low speed, increasing the fan speed will allow more heat transfer to/from the coil. If the Fixed Speed is set to “Auto” and the Fan Mode is set to “Auto,” then when the fan is called for, it runs on the highest speed for which the unit is configured.

Water Valve Operation and H/C Water Available Determination

The application is capable of determining whether heating or cooling water is available even in a stand-alone configuration. If the FlexStat has a call for heating or cooling greater than 10% and the unit does not know what type of water is available (both valves are fully closed), the Flex-Stat will initiate a **water evaluation mode**. During the water evaluation mode, all fan outputs are de-energized and the water valve opens for three minutes. During the three minutes, the water temperature is read. If the water temp is below 63° F (17.2° C), a chilled water available flag is started and water evaluation mode ends. If the water temp is above 90° F (32.2° C), a heating water available flag is started and water evaluation mode ends. These flags will stay on until the valve goes fully shut for ten minutes (or as set in **min eval timer**) or the water drops 2.0° (1.1° C) out of range. If the opposite type of water is available from what type

of water is needed (e.g., cooling water is available and there is a call for heating), another flag indicating opposite water available is started. If the unit goes into “opposite water available” mode and the unit remains calling for the same temperature mode (heating or cooling), every fifteen minutes (or as set in **opposite water timer**) the unit will reinitiate the water evaluation mode. If neither heating nor cooling water is available, the water evaluation mode is run every ten minutes (or as set in **min eval timer**).

NOTE: If adjusted, **min eval timer** should always be set at least 30 seconds lower than **opposite water timer** and is limited in programming to be so.

The method of controlling the valve is based on the fan configuration:

- **If the fan mode for a particular occupancy mode is set to constant or “On,” the valve functions in a modulating fashion.** Actual response may vary slightly due to PI action of the control loops, but generally, if heating water is available, the valve will start to open as the space temperature drops below the active heating setpoint and modulate to fully open when space temperature reaches active heating setpoint minus heating proportional band. The valve modulates closed as the space temp rises towards the active heating setpoint. Likewise, the valve will generally begin opening as the space temperature rises above the active cooling setpoint and be fully open by the time the space temp reaches the active cooling setpoint plus cooling proportional band, modulating linearly in between. Once the valve closes fully in either heating or cooling mode, all water available flags are turned off.
- **With the fan mode set to “Auto,” the valve operates in a “two-position” fashion.** The valve will open 100% if the space temperature falls below active heating setpoint minus heating proportional band and fully close when space temp rises above active heating setpoint if heating water is available. The valve similarly opens 100% if the space temp rises above the active cooling setpoint plus cooling proportional band and fully closes if the space temp falls below the active cooling setpoint if cooling water is available.

Any time there is a fan failure alarm, the valve will be fully closed.

FCU (Fan Coil Unit), 4-Pipe

Fan Control

The fan follows the base sequence for fan operation as listed in the *Flex-Stat (All Models) Common Features* section above with the following modifications.

When the fan runs, whether in “Auto” or “On” mode, the fan speed is determined by the Fixed Speed setting. If the Fixed Speed setting is set to a particular speed (“1,” “2,” or “3”), then any time the fan is called for, it will run at that speed. This allows fan speed to be set by a balancer. If the Fixed Speed is set to “Auto” and the Fan Mode is set to “On,” then the speed the fan runs is determined by the heating or cooling PI loops. The fan is started at low speed upon call for heating or cooling and remains there until the active heating or cooling PI loop reaches 60%. Once above 60%, the fan is incrementally sped up based on the upper 40% of the heating or cooling PI loop, whichever is active based on the number of fan stages configured. The fan slows down in the reverse sequence. This operation allows the FCU to attempt to maintain space temperature setpoint using the valve at low fan speed. If space temp setpoint cannot be maintained at low speed, increasing the fan speed will allow more heat transfer to/from the coil. If the Fixed Speed is set to “Auto” and the Fan Mode is set to “Auto,” then when the fan is called for, it runs on the highest speed for which the unit is configured.

Valve Control

The method of controlling the heating and cooling valves is based on the fan configuration:

- **The method of controlling the heating and cooling valves is based on the fan configuration. If the fan mode for a particular**

occupancy mode is set to constant or “On,” the valves function in a modulating fashion. Actual response may vary slightly due to PI action of the control loops, but generally, the heating valve will start to open as the space temperature drops below the active heating setpoint and modulate to fully open when space temperature reaches active heating setpoint minus heating proportional band. Likewise, the cooling valve will generally begin opening as the space temperature rises above the active cooling setpoint and be fully open by the time the space temp reaches the active cooling setpoint plus cooling proportional band, modulating linearly in between.

- **With the fan mode set to “Auto,” the valves operate in a two-position fashion.** The heating valve will open 100% if the space temperature falls below active heating setpoint minus heating proportional band and fully close when space temp rises above active heating setpoint. The cooling valve similarly opens 100% if the space temp rises above the active cooling setpoint plus cooling proportional band and fully closes if the space temp falls below the active cooling setpoint.

If at any time there is a fan failure alarm, the cooling and heating valves are both forced closed.

Dehumidification

If the dehumidification sequence is enabled on models BAC-10136C/11136C, the dehumidification mode is started and stopped as described in the Common Features section above. Upon activation of the dehumidification mode, the cooling valve is opened 100%. The heating valve then reheats the space as called for in a modified heating sequence to maintain the active cooling setpoint. Upon termination of the dehumidification mode, the valves return to their normal sequence.

BAC-1xx30 Series (3 Relays and 0 Analog Outputs)

This section is specific to the BAC-1xx30 series (with 3 relays and 0 analog outputs).

NOTE: See also the [FlexStat Catalog Supplement and Selection Guide \(SP-091\)](#).

NOTE: IN1 is the room temp. sensor AI1

NOTE: SC = Switched (Relay) Common

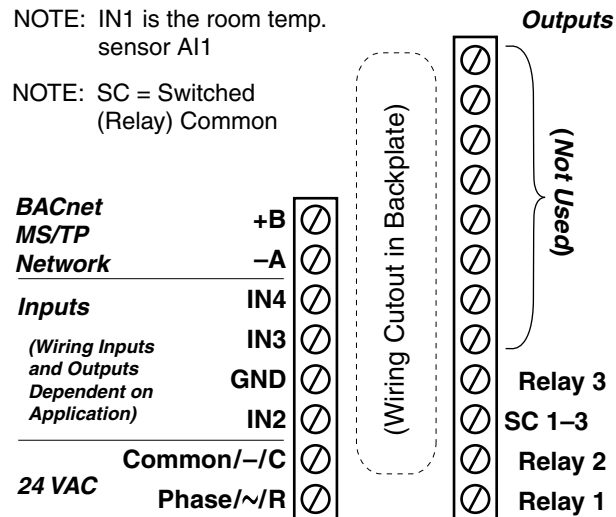

Bills of Materials (BAC-1xx30)

AHU (Air Handling Unit)—1 Heat and 1 Cool

BILL OF MATERIALS: AHU, 1 Heat and 1 Cool		
REFERENCE	KMC PART #	PART DESCRIPTION
FLEXSTAT	BAC-1xx30	BACNET THERMOSTAT, 3 RELAYS
DAT	STE-1402	DUCT TEMPERATURE SENSOR
FST	CSE-1102	AIR DIFFERENTIAL PRESSURE SWITCH, 0.05-12" WC
MAT	STE-1416	12' DUCT AVERAGING TEMP SENSOR
OAT	STE-1451	OUTSIDE TEMPERATURE SENSOR
TX	XEE-6311-075	TRANSFORMER, 120/240/277/480:24 VAC, 75 VA

Cooling Unit—1 Cool

BILL OF MATERIALS: Cooling Unit, 1 Cool		
REFERENCE	KMC PART #	PART DESCRIPTION
FLEXSTAT	BAC-1xx30	BACNET THERMOSTAT, 3 RELAYS
DAT	STE-1402	DUCT TEMPERATURE SENSOR
FST	CSE-1102	AIR DIFFERENTIAL PRESSURE SWITCH, 0.05-12" WC
TX	XEE-6311-075	TRANSFORMER, 120/240/277/480:24 VAC, 75 VA

Heating Unit—1 Heat

BILL OF MATERIALS: Heating Unit, 1 Heat		
REFERENCE	KMC PART #	PART DESCRIPTION
FLEXSTAT	BAC-1xx30	BACNET THERMOSTAT, 3 RELAYS
DAT	STE-1402	DUCT TEMPERATURE SENSOR
FST	CSE-1102	AIR DIFFERENTIAL PRESSURE SWITCH, 0.05-12" WC
TX	XEE-6311-075	TRANSFORMER, 120/240/277/480:24 VAC, 75 VA

HPU (Heat Pump Unit)—1 Compressor

BILL OF MATERIALS: HPU, 1 Compressor		
REFERENCE	KMC PART #	PART DESCRIPTION
FLEXSTAT	BAC-1xx30	BACNET THERMOSTAT, 3 RELAYS
DAT	STE-1402	DUCT TEMPERATURE SENSOR
FST	CSE-1102	AIR DIFFERENTIAL PRESSURE SWITCH, 0.05-12" WC
TX	XEE-6311-075	TRANSFORMER, 120/240/277/480:24 VAC, 75 VA

NOTE: See the [BAC-1xx30 Installation Guide](#) section for detailed drawings and input/output connections as well as other important installation information.

NOTE: Humidity and motion/occupancy sensor options are dependent on the FlexStat model. In BAC-10130/11130, dehumidification or economizer options can be selected but not both.

NOTE: See also [Sequence of Operation \(BAC-1xx30\)](#) on page 64.

⚠ CAUTION

Relays are for Class-2 voltages (24 VAC) only. Do not connect line voltage to the relays!

Sequence of Operation (BAC-1xx30)



For common features, see *FlexStat (All Models) Common Features on page 38*

For HPU applications, see relevant sections in *HPU (Heat Pump Unit) on page 48*

For AHU, Heating Unit, and Cooling Unit applications, see relevant sections in *Sequence of Operation (BAC-1xx36/1xxx36) on page 57*

BAC-1xxx53

(5 Relays, 1 Triac, & 3 Analog Outputs)

The BAC-120053CW FlexStat is a **5-relay, 1-triac,** and **3-analog**-output controller with special firmware that is used to control the **Copeland Scroll® Digital™ compressor.** (See www.EmersonClimate.com.) The BAC-120053CW is similar to the Emerson 543-0175-00 Commercial Comfort Controller (which is manufactured exclusively for the Copeland Scroll Digital compressor by KMC Controls as a customized version of KMC's standard FlexStat). The BAC-120053CW has a KMC logo (instead of Emerson), plus economizer and (with a remote CO₂ sensor) Demand Control Ventilation (DCV) functionality.



The triac replaces Relay 6 and is used to modulate the compressor. HPU and RTU applications (only) are supported. Other specifications are the same as for the BAC-120063C model (see also the [BAC-12xxx/13xxx/14xxx Series FlexStat Data Sheet](#)).

In single compressor applications, the FlexStat varies the capacity of the Scroll Digital compressor over 10–100% of the rated capacity. In multiple compressor (tandem) applications, the FlexStat manages the variable capacity Scroll Digital compressor as the first stage of cooling, effectively providing 5–100% variable capacity control over the full range of cooling demand in a multiple compressor (tandem) application.

For a general bill of material items and general HPU and RTU sequence of operations, see [BAC-1xx63/1xxx63 Series \(6 Relays and 3 Analog Outputs\) on page 34](#).

NOTE: Expected availability of this model is the third quarter of 2012. When available, see the BAC-120053 Installation Guide section for detailed drawings and input/output connections as well as other important installation information.

NOTE: SC = Switched (relay) Common



(Optional) IP/Ethernet Network

NOTE: IN1 and IN5–6 are reserved for internal sensors

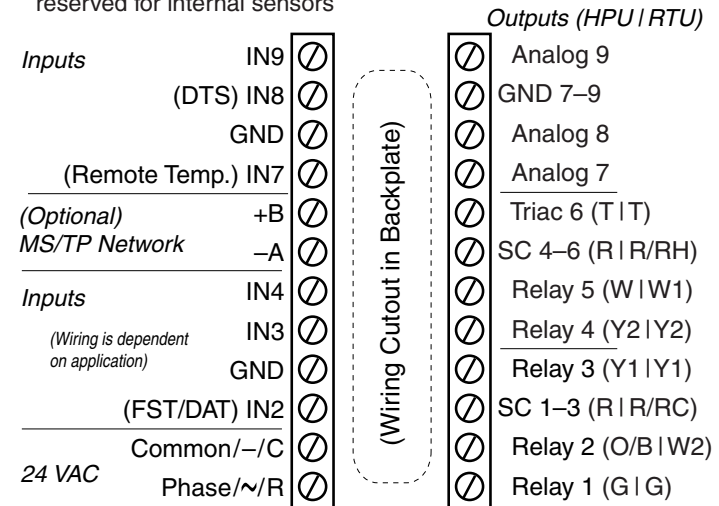

Index

Symbols

2-Pipe: [37](#), [50](#), [56](#), [60](#)
2-Position: [37](#)
3 Relays, 6 Analog Outputs: [53](#)
3 Relays and 0 Analog Outputs: [62](#)
4-20 mA Inputs: [6](#)
4-Pipe: [37](#), [51](#), [56](#), [61](#)
5 Relays, 1 Triac, and 3 Analog Outputs: [65](#)
6 Relays, 3 Analog Outputs: [34](#)

A

Adapter
 Backplate, HTO-1103: [22](#)
 Tubing, CO2 Calibration: [22](#)
Additional Information: [33](#)
Air Handler Unit (AHU): [35](#), [36](#), [47](#), [54](#), [57](#),
 [63](#)
Alarms: [41](#), [47](#), [49](#), [50](#), [58](#), [60](#)
ASHRAE Standard 62: [43](#)
Auxiliary/Emergency Heat: [49](#)
Averaging, Input. *See* Filter Weight

B

BAC-1xx30 Series: [62](#)
BAC-1xx36/1xxx36 Series: [53](#)
BAC-1xx63/1xxx63 Series: [34](#)
BAC-1xxx53 Series: [65](#)
Backlight, Display: [47](#)
BACstage: [14](#), [18](#), [24](#), [26](#)
Binary Inputs: [20](#)

C

Calibration
 Analog Sensors: [7](#)
 CO2 Sensor (Gas): [22](#)
 Temperature Sensor: [7](#)
CA Title 24: [42](#), [43](#)
CO2 Sensor: [21](#), [42](#)
Code
 Common: [15](#)
 Control Basic: [14](#)
Common Code: [15](#)
Compressor
 Copeland Scroll Digital: [65](#)
 Staging (HPU): [48](#)
Conductor Size and Number: [4](#)
Conduit: [4](#)
Configuration: [13](#), [33](#)
Connecting
 Inputs: [5](#), [32](#)
 Outputs: [13](#)
Control Basic Programs: [15](#), [16](#), [20](#)
Cooling Proportional Band: [38](#)
Cooling Unit: [63](#)
Copeland Scroll Digital Compressor: [65](#)
Custom
 Objects: [16](#)
 Programming: [14](#)
 Text in Hospitality Mode: [28](#)
 Web Graphics: [24](#)

D

Damper. *See* Economizer
DCV (Demand Controlled Ventilation): [21](#),
 [42](#)
Deadband (Proportional Band): [38](#)
Dehumidification: [46](#), [48](#), [49](#), [51](#), [52](#), [59](#), [61](#)
Discharge Air Temp: [41](#)
Display: [18](#), [19](#)
Door Contact with Motion Sensor: [31](#)

E

Economizer: [41](#), [52](#), [59](#)
Elevation Correction/Setting: [23](#)
Emergency Heat: [49](#)
Emerson Compressor: [65](#)
External
 250 Ohm Resistor: [6](#)
 Motion Sensors: [32](#)

F

Factory Restore: [16](#)
Fan
 Control: [41](#), [48](#), [51](#), [52](#), [61](#)
 Heating: [41](#)
 Status: [41](#)
Fan Coil Unit (FCU): [37](#), [50](#), [51](#), [60](#), [61](#)
Fan Fail Alarm: [42](#), [47](#), [49](#), [50](#), [51](#), [52](#), [58](#),
 [59](#), [60](#), [61](#)
Field A, B, and C: [25](#)
Filter Weight (Input "Smoothing"): [9](#)

Firmware Updates: [16](#)
Freeze Stat Alarm. *See* Low Limit Alarm

G

Gas, Calibration (CO2): [22](#)
GE Telaire 2075 (CO2 Calibration Kit): [22](#)
GND. *See* Ground
Graphics, Custom: [24](#)
Ground: [13](#)
Ground Loops: [4](#)

H

Heating/Cooling Staging: [47, 48, 52](#)
Heating Fan: [41](#)
Heating Proportional Band: [38](#)
Heating Unit: [63](#)
Heat Pump Unit (HPU): [36, 48, 63](#)
Hospitality Mode: [25](#)
HTO-1103 FlexStat Firmware Flash Upgrade
 Kit: [22](#)
Humidification: [46](#)

I

Images, FlexStat and System: [24](#)
IN7 (Remote Temp. Sensor): [17](#)
Inputs
 Averaging. *See* Filter Weight
 Connecting: [5](#)
 Filter Weight: [9](#)
 Mapping Analog as Binary: [20](#)
Installation: [4](#)

J

Junction Boxes: [4](#)

L

Locked Buttons: [25](#)
Locked User Interface Mode: [25](#)
Low Limit Alarm: [41, 42, 47, 49, 52, 58, 59](#)

M

Modes: [25, 38](#)
Modulating: [37, 56](#)
Motion Detector. *See* Motion Sensor
Motion Sensor
 Customizing: [30](#)
 Enabling/Disabling: [30](#)
 Occupancy Mode: [39](#)
 Override Time: [30](#)
 Performance and Specs: [29](#)
 With Door Contact: [31](#)
Mounting Considerations: [4](#)
MSV (Multi-State Variables): [26, 28](#)

N

Next Generation Control Basic: [14](#)
Night Flush: [46](#)

O

OAT. *See* Outside Air Temperature (OAT)
Objects, Custom: [16](#)
Occupancy
 Modes: [24, 39](#)
 Sensor. *See* Motion Sensor

Operation Guide: [33](#)
Operation, Sequence: [38, 57, 64](#)
Optimum Start: [40](#)
Outputs: [13, 20](#)
Outside Air Temperature (OAT): [19, 41, 59](#)
Overrides: [30, 39](#)

P

PECI (Portland Energy Conservation, Inc.): [43](#)
Phasing, Network and Power: [4](#)
Portland Energy Conservation, Inc. (PECI): [43](#)
Priority Levels: [24](#)
Programming. *See* Control Basic Programs
Proportional. *See* Modulating
Proportional Band: [38](#)
Pull-Up Resistor Switches: [5](#)

R

Relays: [13](#)
Relinquished Default: [26](#)
Remote
 CO2 Sensor: [21](#)
 Motion Sensors: [32](#)
 Temperature Sensor: [17, 35, 54](#)
Reversing Valve: [48](#)
Reverting UI Modes: [26](#)
Roof Top Unit (RTU): [52](#)
Rotation Values: [19](#)
RTD Inputs: [5](#)

S

SAE-10xx CO2 sensors: **21**
SC. *See* Switched Common
Sensor
 Connected to Another Controller: **20**
 Filter Weight: **9**
 Motion/Occupancy: **29, 32**
 On Another Controller: **20**
 Remote Motion/Occupancy: **32**
 Temperature: **7**
Sequence of Operation: **38, 57, 64**
Setpoints: **18, 24, 38**
Space Temp. and Humidity: **24**
Standard Mode: **25**
Standby Mode: **40, 45**
Support Files: **33**
Switched Common: **13**
Switches, EOL and Pull-Up: **5**
System Mode: **39**

T

Temperature Increments, Decimal: **7**
Temperature Sensor
 Calibration: **7**
 Displaying Value: **24**
 Filter Weight: **9**
Terminals: **4**
Thermistor
 Remote/External: **17**
 Type II or III: **17**
TotalControl: **14, 18, 24, 26**
Triac: **65**
Tubing, CO2 Calibration Adapter: **22**
Type II or III Thermistor: **17**

U

UI (User Interface): **24, 25, 47**
Update Manager: **16**

V

Valve Control: **47, 48, 50, 51, 57, 60, 61**
Ventilation Modes in DCV: **44**

W

Web Graphics: **24**
Web Site: **33**
Wiring Considerations: **4**

KMC Controls

19476 Industrial Drive, PO Box 497
New Paris, IN 46553
574.831.5250; Fax 574.831.5252
www.kmcccontrols.com
info@kmcccontrols.com