

Installation, Operation, and Application Guide for AppStat™

BAC-4000 series controllers for
Fan Coil Units, Roof Top Units, and Heat Pump Units.

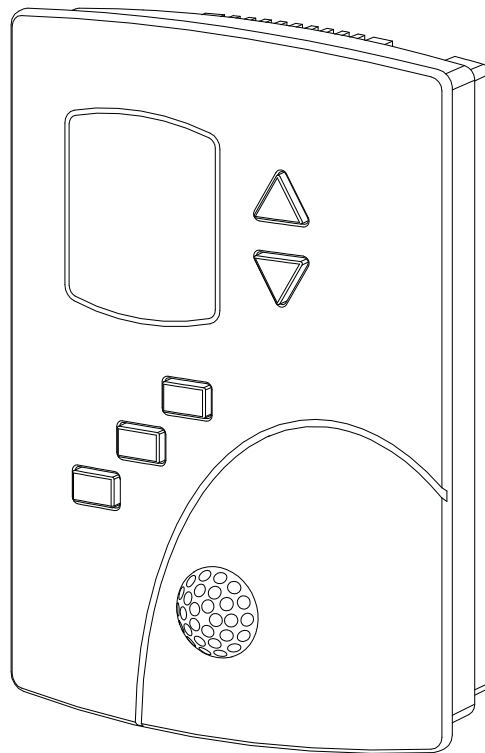

©2013, KMC Controls, Inc.

NetSensor, WinControl, and the KMC logo are registered trademarks of KMC Controls, Inc.

AppStat, BACstage, FlexStat, FullBAC, and TotalControl are trademarks of KMC Controls, Inc.

All rights reserved. No part of this publication may be reproduced, transmitted, transcribed, stored in a retrieval system, or translated into any language in any form by any means without the written permission of KMC Controls, Inc.

Printed in U.S.A.

The material in this manual is for information purposes only. The contents and the product it describes are subject to change without notice. KMC Controls, Inc. makes no representations or warranties with respect to this manual. In no event shall KMC Controls, Inc. be liable for any damages, direct or incidental, arising out of or related to the use of this manual.

KMC Controls, Inc.

P.O. Box 497

19476 Industrial Drive

New Paris, IN 46553

U.S.A.

TEL: 1.574.831.5250

FAX: 1.574.831.5252

E-mail: info@kmccontrols.com

Contents 3

Section 1: Introduction to the AppStat 5

- Specifications 6
- Installation accessories 10
- AppStat model numbers 11
- Safety considerations 13

Section 2: Installing the AppStat 15

- Planning for motion sensing 15
- Mounting the AppStat 16
- Connecting inputs 18
- Connecting outputs 21
- Connecting power 23
- Maintenance 24

Section 3: User functions 25

- Operating the AppStat 25
- Entering a user password 28
- Changing the active setpoints 29
- Setting the operating modes 30

Section 4: Commissioning functions 33

- Enter the commissioning mode 34
- Setting the commissioning setpoints 35
- Set up communications 37
- Set the time and date 38
- Setting the occupancy schedule 40
- Set fan coil unit system options 43
- Set roof top unit system options 46
- Set heat pump unit system options 49
- Advanced options 53

Section 5: Sequences of operation 57

- Room temperature setpoints 58
- Occupancy 59
- Automatic cooling and heating changeover 59
- Schedules 60
- Dehumidification sequence 60
- PID control loops 60
- Valve operation for fan coil units 61
- Fan operation for fan coil units 62
- Modulating cooling and heating for roof top units 63

- Staged heating and cooling for roof top and heat pump units 63
- Fan control for roof top and heat pump units 64
- Economizer cooling for roof top and heat pump units 64
- Heat pump unit specific functions 65
- Section 6: Application drawings 67**
 - Fan Coil Unit applications 68
 - Roof Top Unit applications 84
 - Heat Pump Unit applications 92
- Section 7: System integration 97**
 - BACnet objects 98
 - Connecting to a network 104
- Index 107**

Section 1: **Introduction to the AppStat**

This section provides a description of the BAC-4000 series of controllers from KMC Controls. It also introduces safety information. Review this material before installing or operating the controllers.

The BAC-4000 series of controllers are space mounted devices that combine a BACnet controller with temperature, humidity and motions sensors. The controllers include programs for the following applications.

- ◆ Roof top units, both single or multi-stage, or similar split or unitary packaged systems
- ◆ Heat pumps
- ◆ Two and four pipe fan coil units

The AppStat controllers are native BACnet, Application Specific Controllers. BACnet communication parameters, device instance, MAC address, baud rate, user adjustments, and application configuration values are set from password protected front panel controls.

All models feature an integrated BACnet schedule and hardware real-time clock with 72-hour capacitor backup for standalone operation or network time synchronization.

A two-piece mechanical design, featuring a removable backplate, facilitates easy wiring and installation.

Specifications

AppStat specifications are subject to change without notice.

User Interface

The user interface is a color display and with five push buttons. Through the menu driven display, an operator can do the following.

- ◆ Add or change user passwords
- ◆ Change setpoints
- ◆ Set BACnet addressing
- ◆ Set up and commission the installation
- ◆ Configure any available options

Security

Separate passwords for users and controls technicians.

Display type

- ◆ 128 ×128 pixels
 - ◆ Active color LCD with LED back lighting
 - ◆ 1.00 × 1.04 inches (25 × 26 mm)
-

Inputs and outputs

All inputs and outputs are preprogrammed and application specific. No field configuration is required for most installations. For details on input on output connections see the section [Application drawings on page 67](#).

Analog inputs

Analog inputs represent BACnet analog input objects and are configured for discharge air temperature, remote temperature sensor, water temperature sensor, and fan status. Not all input sensors are applicable or required for all models.

- ◆ Sensors are automatically detected.
- ◆ Inputs accept industry-standard 10,000 Ω , Type II or Type III thermistors sensors.
- ◆ Input overvoltage protection up to 24 volts AC, continuous.
- ◆ 12-bit analog-to-digital conversion

Analog outputs

Analog outputs are configured to represent BACnet analog objects. The outputs control modulating valves, variable speed fans, damper positions or other equipment that requires a proportional input signal.

- ◆ Short-circuit protected
- ◆ Loads up to 10 mA at 0–12 volts DC
- ◆ 8-bit PWM digital-to-analog conversion

Relay outputs

Relay outputs are configured to represent BACnet binary objects. The outputs control on/off valves, speeds for three-speed fans, fan start circuits, or other equipment that requires an on or off input signal.

- ◆ All relay outputs are normally open, SPST, Form “A” relays
- ◆ 1 Ampere maximum per relay at 24 volts AC or DC for each output. Maximum for all relay outputs is 3 amperes (72VA).

Connectors

- ◆ Screw terminal block mounted to backplate
- ◆ Wire size 14-22 AWG

Communications—BACnet MS/TP

- ◆ Integral peer-to-peer BACnet MS/TP network communications.
- ◆ Network speeds from 9600 to 76,800 baud.
- ◆ Front panel configurable device instance, MAC address, and baud.
- ◆ Automatic baud detection.
- ◆ Screw terminal block mounted to backplate. Wire size 14–22 AWG
- ◆ Meets or exceeds ANSI/ASHRAE BACnet Standard 135-2008 for Application Specific Controllers

Accuracy–temperature only models

Type	Thermistor
Accuracy	±0.36° F (±0.2° C)
Resistance	10,000 Ω at 77° F (25° C)
Operating range	48 to 96° F (8.8 to 35.5° C)

Accuracy–temperature and humidity models

Temperature Sensor

Type	CMOS
Accuracy	±0.9° F offset (±0.5° C) from 40° to 104° F (4.4 to 40° C)
Resolution	±0.1°F (±0.1° C)
Operating range	36 to 120° F (2.2 to 48.8° C)

Response time	5 to 30 seconds
---------------	-----------------

Humidity Sensor

Type	CMOS
Humidity	0 to 100% RH
Accuracy at 25° C	± 2% RH from 10 to 90% RH
Response time	4 seconds or less

Regulatory

- ◆ UL 916 Energy Management Equipment
- ◆ FCC Class A, Part 15, Subpart B and complies with Canadian ICES-003 Class B
- ◆ BACnet Testing Laboratory listed as an application specific controller (listing applied for)
- ◆ SASO PCP Registration KSA R-103263

This device complies with part 15 of the FCC Rules. Operation is subject to the following two conditions: (1) This device may not cause harmful interference, and (2) this device must accept any interference received, including interference that may cause undesired operation.

Environmental limits

Operating	32 to 120° F (0 to 49° C)
Shipping	-40 to 140° F (-40 to 60° C)
Humidity	0-95% relative humidity (non-condensing)

Installation

Supply voltage	24 volts AC (-15%, +20%), 50-60 Hz, 12 VA, Class 2 only, non-supervised. All circuits, including supply voltage, are power limited circuits.
Weight	Approximately 6 ounces (170 grams)
Case material	Flame retardant plastic

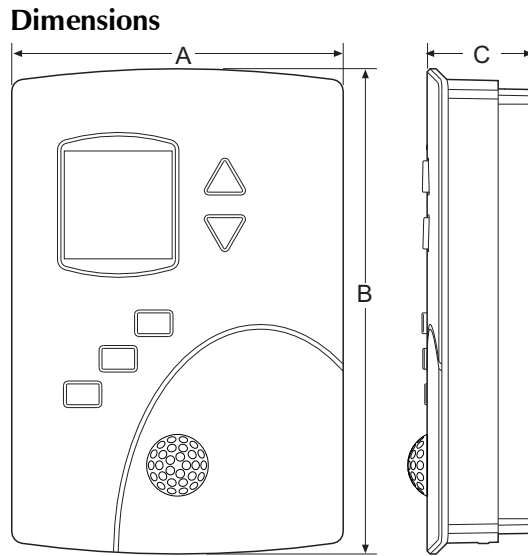

Table 1-1 AppStat Dimensions

A	B	C
3.50 in.	5.12 in.	1.12 in.
89 mm	130 mm	29 mm

Motion sensor

Motion sensors are options available only on select models.

Detector type Passive infrared

Range 33 feet (10 meters). See diagrams

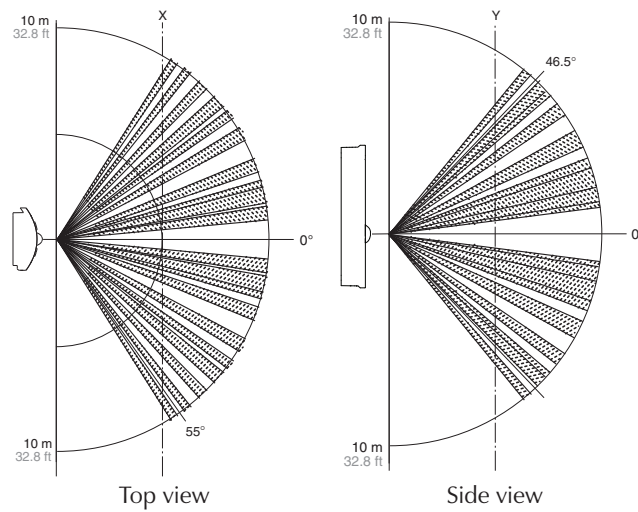

Installation accessories

The following accessories are available from KMC Controls, Inc.

XEE-6111-040	Single-hub 120 volt power transformer
XEE-6112-040	Dual-hub 120 volt power transformer
XEE-6311-075	120/240/277/480VAC, 24 VAC, 75 VA transformer
HMO-10000W	White mounting plate kit for retrofit on horizontal boxes or 4 x 4 handy boxes

AppStat model numbers

Use the following charts to identify features in a specific AppStat model.

Fan coil units—The model numbers for these controllers end with "0001". See the following illustration for the specific features included with each model.

Illustration 1–1 Model numbers for fan coil units

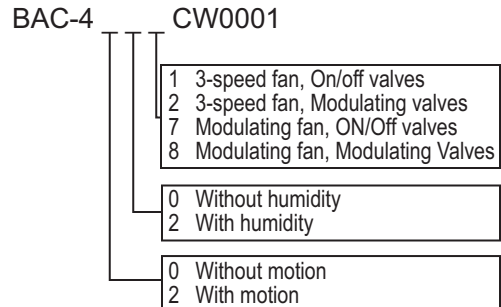

Roof top units—The model numbers for these controllers end with "0002". See the following illustration for the specific features included with each model.

Illustration 1–2 Model numbers for roof top units

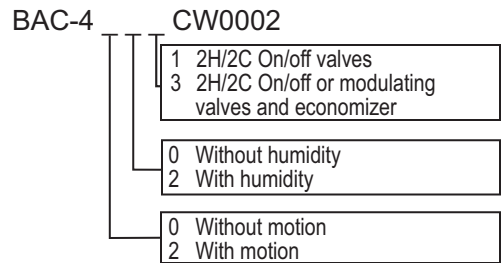

Heat pump units—The model numbers for these controllers end with "0003". See the following illustration for the specific features included with each model.

Illustration 1–3 Model numbers for heat pump units

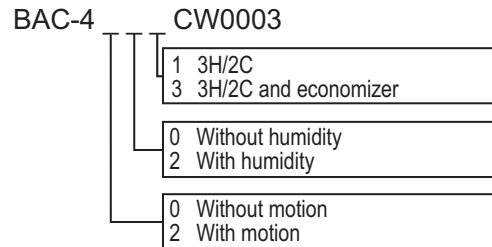

Safety considerations

KMC Controls assumes the responsibility for providing you a safe product and safety guidelines during its use. Safety means protection to all individuals who install, operate, and service the equipment as well as protection of the equipment itself. To promote safety, we use hazard alert labeling in this manual. Follow the associated guidelines to avoid hazards.



Danger represents the most severe hazard alert. Bodily harm or death will occur if danger guidelines are not followed.



Warning represents hazards that could result in severe injury or death.



Caution indicates potential personal injury, equipment damage, or property damage if instructions are not followed.

Note: Notes provide additional information that is important.

Tip: Provides programing tips and shortcuts that may save time.

Section 2: Installing the AppStat

This section provides important instructions and guidelines for installing the AppStat. Carefully review this information before installing the controllers.

Installing the sensors includes the following topics that are covered in this section.

- ◆ [Planning for motion sensing on page 15](#)
- ◆ [Mounting the AppStat on page 16](#)
- ◆ [Connecting inputs on page 18](#)
- ◆ [Connecting outputs on page 21](#)
- ◆ [Connecting power on page 23](#)
- ◆ [Connecting to a network on page 104](#)
- ◆ [Maintenance on page 24](#)

Planning for motion sensing

For models with a motion sensor mount the AppStat on a wall that will have an unobstructed view of the typical traffic in the coverage area. When choosing a location, do not install the sensor in the following areas.

- ◆ Behind curtains or other obstructions
- ◆ In locations that will expose it to sunlight or heat sources
- ◆ Near a heating or cooling inlet or outlet.

For details on the coverage pattern, see [Specifications on page 6](#).

Illustration 2–1 Typical motion sensing coverage area

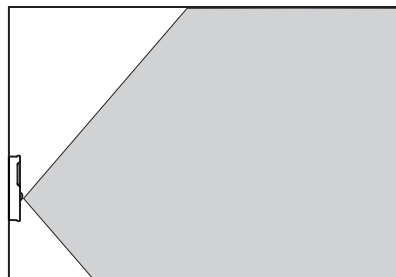

The effective detection range is approximately 10 meters or 33 feet. Factors that may reduce the range include:

- ◆ The difference between the surface temperature of the object and the background temperature of the room is too small.
- ◆ Object movement in a direct line toward the sensor.
- ◆ Very slow or very fast object movement.
- ◆ Obstructions as shown in the illustration *Typical motion sensing coverage area* on page 15.

False detections may be triggered by:

- ◆ The temperature inside the detection range suddenly changes because of the entry of cold or warm air from an air-conditioning or heating unit.
- ◆ The sensor being directly exposed to sunlight, an incandescent light, or other source of far-infrared rays.
- ◆ Small animal movement.

Mounting the AppStat

For the most accurate performance, install the AppStat on an inside wall where it can sense the average room temperature. Avoid locations with direct sunlight, heat sources, windows, air vents, and air circulation or obstructions such as curtains, furniture, etc.

The AppStat must not be:

- ◆ Mounted on an exterior wall.
- ◆ Mounted on or near an object with large a thermal mass such as a concrete block wall.
- ◆ Blocked from normal air circulation by obstructions.
- ◆ Exposed to heat sources such as lights, computers, copiers, or coffee makers, or to direct sunlight at any time of the day.
- ◆ Exposed to drafts from windows, diffusers, or returns.
- ◆ Exposed to air flow through connecting conduits or empty spaces behind walls.

For models with motion sensing, see the topic, *Planning for motion sensing*.

Rough-in preparation

Complete rough-in wiring at each location before mounting an AppStat. This includes the following steps.

- ◆ Install the supplied mounting base directly to a wall, a vertical electrical box, or a box with a wall plate kit.
- ◆ Routing the connecting cable or cables from the AppStat to the equipment it is controlling.
- ◆ If required, install an appropriate wall plate kit.
- ◆ Block leaks and airflow from conduits with plumber’s putty or similar material.
- ◆ If replacing an existing thermostat, label existing wires for reference when removing the existing thermostat.

Illustration 2–2 AppStat mounting base details

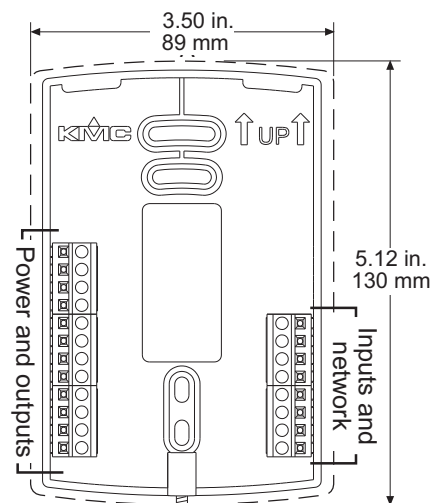

Installing the AppStat

To install the controller on a mounting base, do the following:

1. Turn the Allen screw in the base of the sensor clockwise until it clears the case.

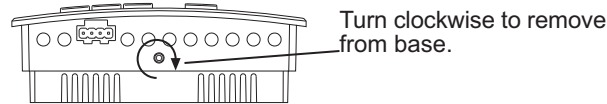

2. Swing the AppStat away from the mounting base to remove it.
3. Route wiring for the AppStat through the mounting base.
4. Position the base with the embossed UP toward the ceiling and fasten it directly to a vertical 2 x 4 inch electrical box. For horizontal boxes or 4 x 4 applications, use a wall plate kit. See [Installation accessories on page 10](#) for part numbers.
5. Connect the wires for the AppStat to the terminals in the mounting base.
6. Place the top of the sensor over the top of the mounting base and swing it down over the Allen screw bracket. Be careful not to pinch any wiring.
7. Turn the Allen screw counterclockwise until it backs out of the mounting base and engages the case.

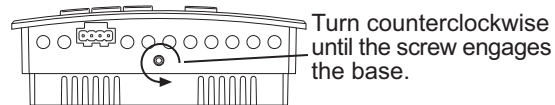

To prevent mounting screw heads from touching the circuit board in the controller, use only the mounting screws supplied by KMC Controls. Using screws other than the type supplied may damage the AppStat.

Connecting inputs

The inputs for the AppStat are configured for specific functions and do not require set up in the field. Not all inputs are required for every model or application.

Remote space temperature sensor (optional)

Connect a 10k Ω , Type II thermistor temperature sensor to the remote space temperature (RS) input and ground (GND) terminals. The input includes the internal pull-up resistor. An STE-6011W10 sensor is suitable for this application. Follow the instructions supplied with the sensor for installation.

When a remote space temperature input is connected to the AppStat, the remote temperature is used instead of the internal temperature sensor.

Illustration 2-3 Wiring for remote space temperature sensor

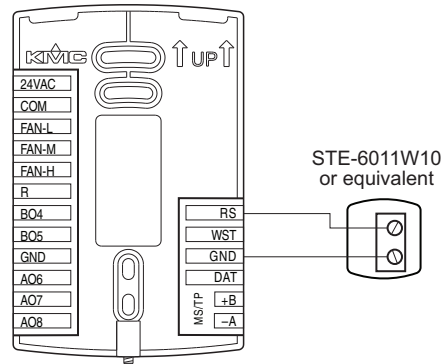

Discharge air temperature

Connect a 10kΩ, Type III thermistor temperature probe to the discharge air temperature (DAT) input. The input includes the internal pull-up resistor. An STE-1405 sensor is suitable for this application. Follow the instructions supplied with the sensor for installation.

Illustration 2-4 Wiring for Discharge Air Temperature Sensor

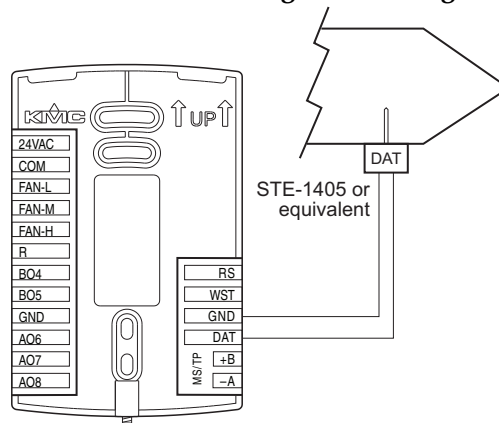

Fan status switch (optional)

Connect a Normally Closed Fan Status switch to the Discharge Air Temperature (DAT) input and ground (GND) terminals. The input includes the internal pull-up resistor. A CSE-1102 differential pressure switch is suitable for this application. Follow the instructions supplied with the switch for installation.

Illustration 2-5 Wiring for a fan status switch

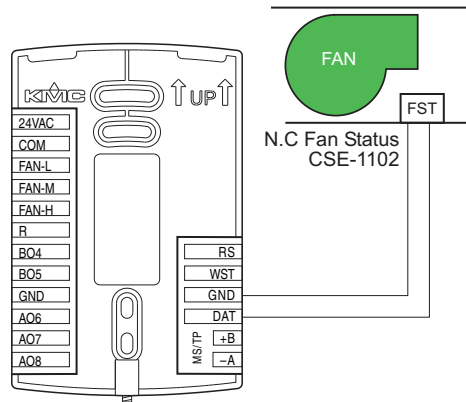

Water temperature sensor

Connect a 10kΩ, Type III thermistor temperature probe to the water temperature (WST) input. The input includes the internal pull-up resistor. An STE-1455 sensor is suitable for this application. Follow the instructions supplied with the sensor for installation.

Note: The water temperature sensor is a required input sensor for 2-pipe fan coil units.

Illustration 2-6 Wiring for a water temperature sensor

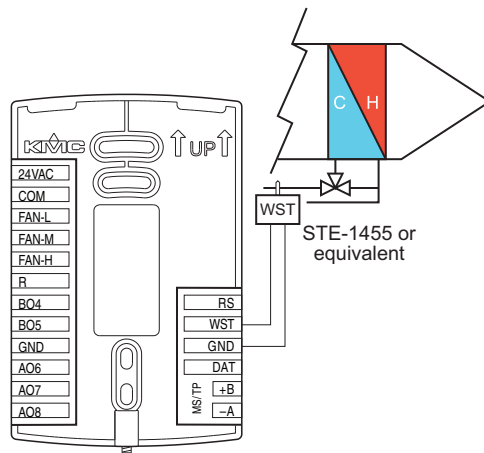

Outside air temperature

Connect a 10kΩ, Type III thermistor temperature probe to the outside air temperature (OAT) input. The input includes the internal pull-up resistor. An STE-1451 sensor is suitable for this application. Follow the instructions supplied with the sensor for installation.

Illustration 2-7 Wiring for an outside air temperature sensor

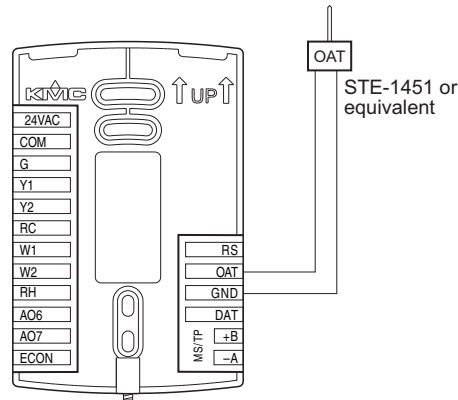

Connecting outputs

The AppStat outputs are model dependent and are configured for specific applications.

- ◆ No field programming or set up is required or possible.
- ◆ Depending on model and application, the AppStat outputs are designed for either 24 volt AC or 0-10 volt DC loads.
- ◆ The outputs may represent analog or digital signals.



Caution

Improperly connecting loads or equipment to output terminals may damage the equipment. Connect only as shown in the following diagrams or application drawings.

Connecting to a three-speed fan

The following diagram shows the connections for a three-speed fan. The fan circuits must be a 24-volt AC pilot duty only.

- ◆ For a single-speed fan, use only the FAN-L connection.
- ◆ For a two-speed fan, use the FAN-L and FAN-H connections.
- ◆ For a three-speed, use FAN-L, FAN-M, and FAN-H

Illustration 2-8 Connections to a three-speed fan

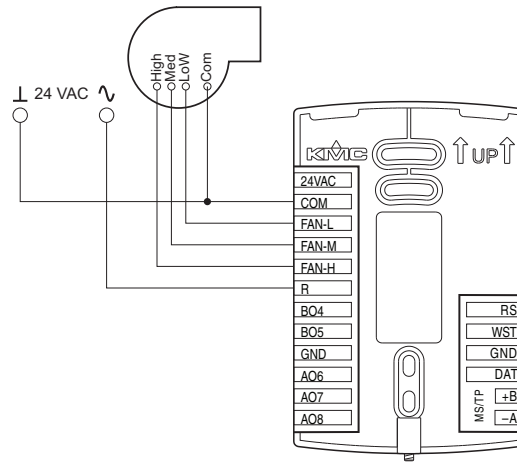

Connecting to a modulating fan

The following diagram shows the connections for a modulating speed fan.

- ◆ The fan start circuit must be a 24-volt AC circuit. Connect it to the FAN-L terminal.
- ◆ The speed control is a 0-10 volt DC analog output.

Illustration 2-9 Connections for a modulating fan

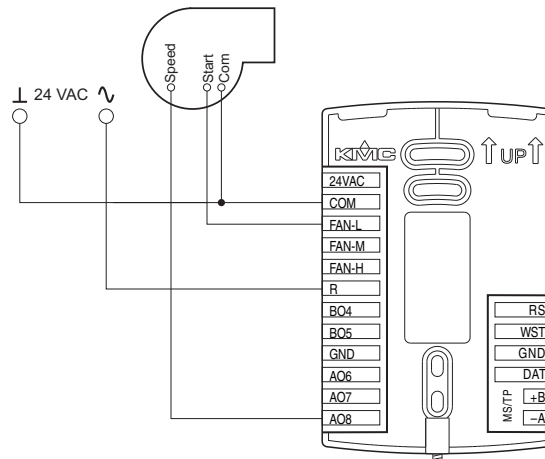

Connecting on/off valves

The following diagram shows the connections on/off valves.

- ◆ The valves are activated by 24-volts AC.
- ◆ The outputs are 24-volt relays.

Illustration 2–10 Connections to on/off valves

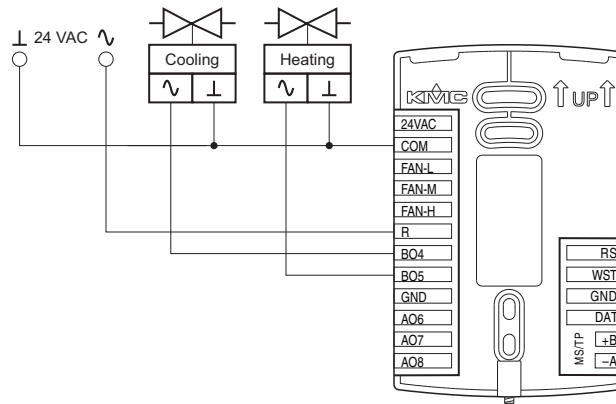

Connecting to modulating valves

The following diagram shows the connections for a modulating mixing valves. The valve control signal is a 0-10 volt analog output.

Illustration 2–11 Modulating heating and cooling valves

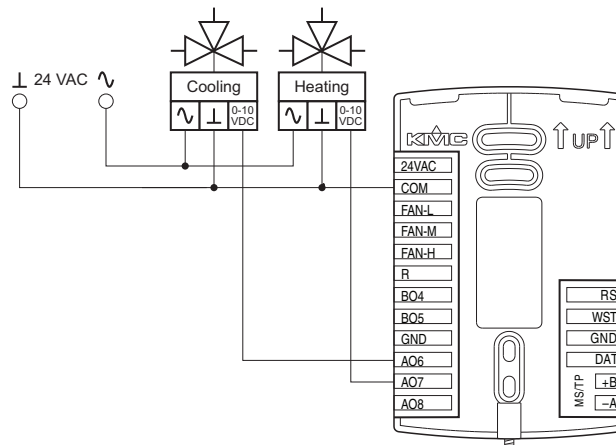

Connecting power

The AppStat requires an external, 24 volt, AC power source. Use the following guidelines when choosing and wiring transformers.

- ◆ Use only a Class-2 transformer of the appropriate size to supply power.
- ◆ KMC Controls recommends powering the AppStat from a dedicated controls transformer.
- ◆ Connect the transformer’s neutral lead to the COM terminal.
- ◆ Connect the AC phase lead to the 24VAC terminal.
- ◆ Power is applied to the controller when the transformer is powered.

See [Installation accessories on page 10](#) for a list of transformers available from KMC Controls, Inc.

Illustration 2–12 Wiring for AppStat power

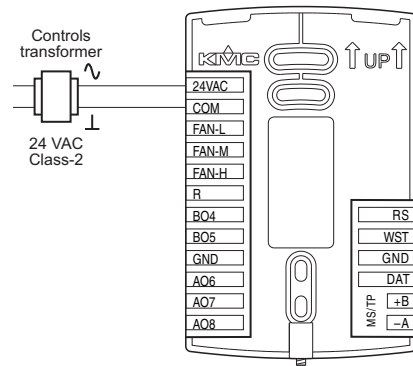

Maintenance

Remove dust as necessary from the holes in the top and bottom. Clean the display with soft, damp cloth and mild soap.

Section 3: User functions

This section covers topics for the end user in a facility.

AppStat user functions are limited to changing the following functions.

- ◆ Active temperature setpoints
- ◆ Fan operation
- ◆ Changing between heating and cooling
- ◆ Override scheduled occupancy or occupancy based on the schedule in the AppStat.
- ◆ Change the display between Fahrenheit and Celsius

Operating the AppStat

AppStat functions are accessible through a user interface consisting of simple, context sensitive menus. The menus are opened and options are selected by using the buttons and a color display on the front of the AppStat.

- ◆ Pressing either the up button ▽ or down ▲ button changes a selection, setting, or value.
- ◆ Pressing the Enter button saves the selected setting or value. Typically the Enter button is the middle of the three buttons below the display.
- ◆ Saving a selection also advances to the next display.

Illustration 3–1 AppStat display and buttons

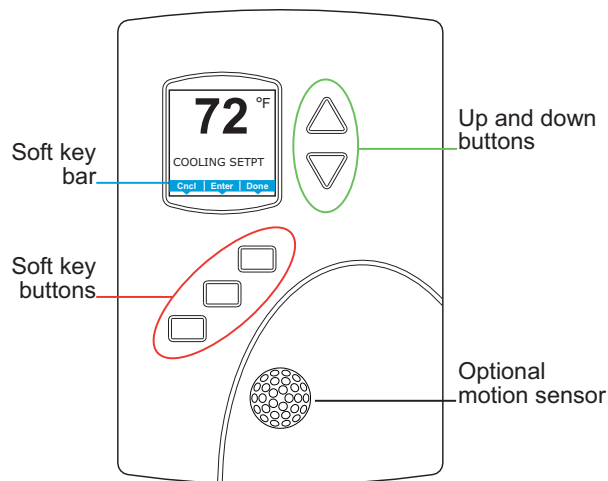







The three buttons below the display are defined by labels in the soft key bar. Typically the buttons are designated for the following functions.



- ◆ **Back**—Returns to the previous menu.
- ◆ **Cncl**—Cancels current changes.
- ◆ **Done**—Push this button at any point while entering a value. For example, if you have entered the first two digits of a password and the remaining two digits are correct, pushing Done completes the entry of the password.
- ◆ **Enter**—Pushing this button enters the selection and advances to the next step.
- ◆ **Exit**—Returns to temperature display.

The operating modes of the AppStat are represented by the display icons.

Table 3-1 Operating mode icons

Icon	Description	Mode
	The fan icon rotates when the system fan is operational. In systems with multispeed fans the icon rotation is the same regardless of speed. When fan operation is set to automatic, the word "Auto" is placed under the icon.	Fan
	Occupied—Occupancy is set to occupied by the schedule maintained in the controller.	Occupancy
	Unoccupied—Occupancy is set to unoccupied by the schedule maintained in the controller.	Occupancy
	Standby—The space is temporarily unoccupied because of lack of detected motion in the room.	Occupancy
	Override—A user has entered temperature setpoints that override the unoccupied setpoints.	Occupancy
	Cooling—The system will cool the space until the cooling setpoint is reach. The icon is in motion when cooling is taking place.	Heating/Cooling



Operating mode icons (continued)

Icon	Description	Mode
	Heating—The system will heat the space until the heating setpoint is reached. The icon is in motion when heating is taking place.	Heating/Cooling
Off	System is off	Heating/Cooling
	Dehumidification—During dehumidification the system will heat and cool at the same time to remove humidity and maintain the active temperature setpoint. The icon is in motion while dehumidification is taking place.	Heating/Cooling

Entering a user password

User functions may require a password consisting of four numbers. Once a user password is entered it will remain active for 60-seconds after the last button is pushed.

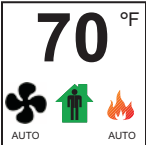
Enter a user password

Procedure	Steps	Display
Starting display	Start at the temperature display.	
Enter the Level 1 password.	<ol style="list-style-type: none"> 1. Press any button on the AppStat. The display changes to the Security User Level display. 2. Press either the ▽ or △ button to change the first digit of the password. 3. Press the Enter button to select the next digit. Repeat for all four digits. 4. If the password is correct, the display will advance to the first menu. 	

Changing the active setpoints

To enter or change the active temperature setpoints you may need user password. To enter the password, see [Entering a user password on page 28](#).

Note:

In the following procedure the current active setpoint—either cooling or heating—is the first setpoint to change. Once that setpoint is entered, the display advances to the next setpoint.

To change the operation of the fan, occupancy, or heating/cooling, see the topic [Setting the operating modes on page 30](#).

Change the active temperature setpoints

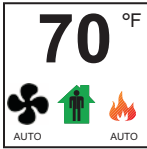
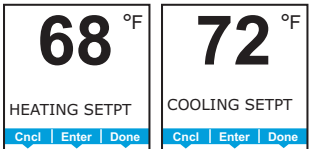
Procedure	Steps	Display
Starting display	<p>Start at the temperature display.</p> <p>Note: The next step may require a user password. See Entering a user password on page 28.</p>	
Change the active setpoints	<ol style="list-style-type: none"> Press either the ∇ or Δ button to change the active temperature setpoint. Note: A user password may be required after pushing the first button. Press the Enter button to save the value. The display will advance to the next setpoint Press either the ∇ or Δ button to change the next setpoint. Press the Enter button to save the value. The display will return to the temperature display. 	



Setting the operating modes

The operating modes set the following functions.

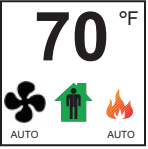
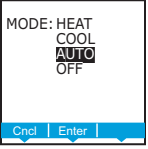
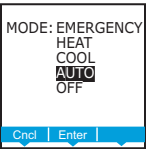

- ◆ Fan operation
- ◆ Changing between heating and cooling
- ◆ Override scheduled occupancy or occupancy that has been set by a schedule.
- ◆ Change the display units from Fahrenheit to Celsius.

To change the occupied temperature setpoints, see the topic [Changing the active setpoints on page 29](#).

Set the operating modes

Procedure	Steps	Display
Starting display	Start at the temperature display. Note: The following procedures may require a user password. See Entering a user password on page 28 .	
Change the heating or cooling mode.	<ol style="list-style-type: none"> 1. Push the button under the heating/cooling icon. Note: If a user password has previously been entered or if the AppStat has not been set up with a user password, entering a password is not required. 2. Press either the ▽ or △ button to select the heating/cooling mode. The mode may be one of the following. Emergency—(Option) Turns on the auxiliary heating in a heat pump unit. Heat—The system will only heat the space. Cool—The system will only cool the space. Auto—The system will switch between heating and cooling. Off—The system is turned off. 3. Press the Enter button to save the setting. The display returns to the temperature display. 	   Heating/cooling icons

Set the operating modes (continued)

Procedure	Steps	Display
Set the fan mode.	<ol style="list-style-type: none"> 1. Push the button under the fan icon. Note: If a user password has previously been entered or if the AppStat has not been set up with a user password, entering a password is not required. 2. Press the Enter button to select the next digit. Repeat for all four digits. 3. Press either the ∇ or Δ button to select the fan mode from the following options. <ul style="list-style-type: none"> ◆ Auto—Sets the fan to run only when there is a call for heat or cooling. The word AUTO will be placed under the fan icon. ◆ On—Sets a single speed fan will run continuously. ◆ Low, Med, High—Sets the speed at which 3-speed or modulating fans will run continuously. 4. Press the Enter button to save the setting. The display returns to the temperature display. 	 <p>Fan icon</p>  <p>1-speed fan option</p>  <p>Multi-speed fan option</p>

Set the operating modes (continued)

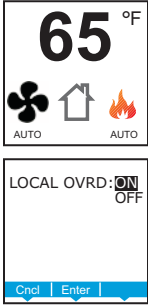
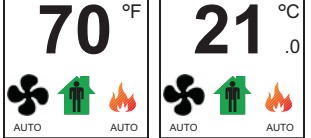
Procedure	Steps	Display
<p>Change the override setpoint</p>	<p>Entering an override setpoint can only take place if the AppStat is in the unoccupied mode.</p> <ol style="list-style-type: none"> 1. Push the button under the unoccupied icon . <p>Note: If a user password has previously been entered or if the AppStat has not been set up with a user password, entering a password is not required.</p> <ol style="list-style-type: none"> 2. Press either the ▽ or △ button to change the first digit of the password. 3. Press the Enter button to select the next digit. Repeat for all four digits. 4. Press either the ▽ or △ button to turn the override on or off. <p>Override Off—The controller uses the unoccupied setpoint as the active setpoint.</p> <p>Override On—the controller changes to the occupied setpoint which can then be temporarily changed.</p> 5. Press the Enter button to save the setting. <p>Note: When the system is in the unoccupied mode, changing the active setpoint will automatically place the system in the override mode.</p>	
<p>Change the display units</p>	<p>To temporarily change the display units to either Celsius or Fahrenheit, press and hold the middle button under the display until the units change.</p>	

Section 4: **Commissioning functions**

This topics in this section are advanced topics for control technicians and engineers. These topic cover procedures for the initial AppStat setup.

The AppStat commissioning functions are values and settings that are entered during the installation and commissioning of a controller and the equipment it is controlling. Typically these functions do not change after the installation and commissioning process.

To set up the commissioning functions, you will need the following information.

- ◆ Information about the equipment
- ◆ The sequence of operation for the equipment
- ◆ The building automation system plans for controllers that are part of a network.

Users may change the occupied heating and cooling setpoints without accessing the commissioning functions. This procedure is covered in the topic [User functions on page 25](#).

Note:



The instructions for the AppStat commissioning functions cover all of the functions that can be set in the controller. Not all functions are available on every model of controller. Consult the installation and operation manual supplied with the controller to verify the application programming in the AppStat.

Enter the commissioning mode

For access to the commissioning functions you will need to know Password 2.

- ◆ If the controller has not been previously set up, no password is required.
- ◆ A new Password 2 can be entered in the advanced commissioning functions. See the topic *Advanced options* on page 53.

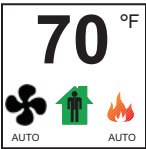
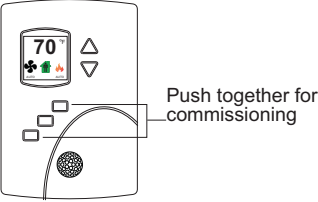
Enter the commissioning mode



Procedure	Steps	Display
Starting display	Start from the temperature display.	
Enter the commissioning password	<ol style="list-style-type: none"> 1. Press the left and right buttons below the display at the same time and hold them until the display changes to the SECURITY USER LEVEL display. Note: If Password 2 has not previously been entered, the display will change to the MAIN menu. 2. Press either the ▽ or △ button to change the first digit of Password 2. 3. Press the Enter button to select the next digit. Repeat for all four digits. The Enter button is the middle of the three buttons below the display. 	 <p>Push together for commissioning</p> 
Select a commissioning function	Access to the commissioning functions always starts at the MAIN menu display.	

Setting the commissioning setpoints

The commissioning setpoints set the operational setpoints and limits for the AppStat. The functions of the setpoints and how they are used are describe in the topic [Room temperature setpoints on page 58](#). Setting commissioning setpoints requires entering Password 2 which is described in the topic [Enter the commissioning mode on page 34](#).

Note: Not all setpoints in the following procedure are applicable to all models of AppStat. Those setpoints are marked as (optional).

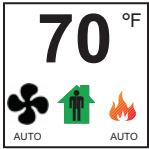
Procedure to set the commissioning setpoints

Procedure	Steps	Display
Starting display	<ol style="list-style-type: none"> 1. Start at the temperature display. 2. Enter Password 2. The display changes to the MAIN menu display. 	 
Choose and set the setpoints.	<ol style="list-style-type: none"> 1. From the MAIN menu , press either the ▽ or △ button to select SETPOINTS. 2. Press Enter. The SETPOINT menu opens 3. Choose and set each of the following setpoints. 	

Procedure to set the commissioning setpoints (continued)

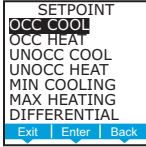
Procedure	Steps	Display
	<ul style="list-style-type: none"> ◆ OCC COOL—The cooling setpoint that is used as the active setpoint when the system is occupied. ◆ OCC HEAT—The heating setpoint that is used as the active setpoint when the system is occupied. ◆ UNOCC COOL—The cooling setpoint that is used as the active setpoint when the system is unoccupied. ◆ UNOCC HEAT—The heating setpoint that is used as the active setpoint when the system is unoccupied. ◆ MIN COOLING—The minimum cooling setpoint that a user can select as the active setpoint. ◆ MAX HEATING—The maximum heating setpoint that a user can select as the active setpoint. ◆ DIFFERENTIAL—The minimum value between the cooling or heating setpoints. The AppStat will always maintain this difference between setpoints. ◆ STBY OFFSET—(optional) A value used to calculate the standby setpoint. The standby setpoint is calculated by adding or subtracting the unoccupied setpoint to or from the standby offset value. ◆ DEHUM SETPOINT—(optional) Sets the setpoint for dehumidification. Dehumidification starts when the relative humidity is above the dehumidification setpoint. ◆ DEHUM DEADBAND—(optional) The system will remain in dehumidification until the relative humidity falls below a value of dehumidification setpoint minus the dehumidification deadband value. 	 <p>The screenshot shows a menu titled 'SETPOINT' with the following options: OCC COOL (highlighted), OCC HEAT, UNOCC COOL, UNOCC HEAT, MIN COOLING, MAX HEATING, and DIFFERENTIAL. At the bottom, there are three buttons: Exit, Enter, and Back.</p>

Set up communications

Setting BACnet communications properties is required only if the AppStat is integrated into a network with other BACnet controllers. Entering the communications properties requires entering Password 2 which is described in the topic [Enter the commissioning mode on page 34](#).

See the topic [Connecting to a network on page 104](#) for network wiring details.

Set BACnet communication properties

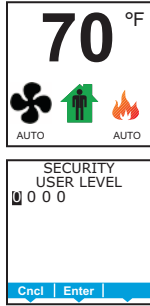
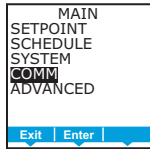
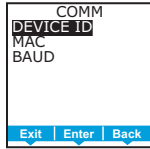
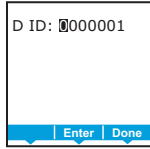
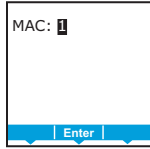
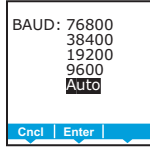
Procedure	Steps	Display
Starting display	<ol style="list-style-type: none"> 1. Start at the temperature display. 2. Enter Password 2. The display changes to the MAIN menu display. 	
Change the network communication properties.	<ol style="list-style-type: none"> 1. From the MAIN menu , press either the ▽ or △ button to select COMM. 2. Press Enter. The COMM menu opens. 3. Choose and set the following properties. <ul style="list-style-type: none"> • DEVICE ID—This is the BACnet device instance. The device instance must be within the range of 1 to 4,194,302. • MAC—The MAC address must be in the range of 1-127. • BAUD—Set to match other devices on the BACnet MS/TP network. The choices are Auto, 9600, 19,200, 38,400, or 76,800. <p>Note: After changing an communication property the AppStat will reset.</p> 	    

Set the time and date



Setting the time and date requires entering Password 2 which is described in the topic [Enter the commissioning mode on page 34](#).

Note:

If the AppStat is connected to a BACnet network that includes a time service master, the time and date are automatically set to the network time and date.

To change the schedule, see the procedure [Setting the occupancy schedule on page 40](#).

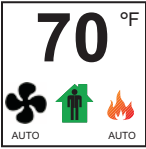
Set the time and date

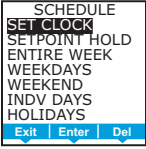
Procedure	Steps	Display
Starting display	<ol style="list-style-type: none"> 1. Start at the temperature display. 2. Enter Password 2. The display changes to the MAIN menu display. 	 
Select the SCHEDULE menu.	<ol style="list-style-type: none"> 1. From the MAIN menu , press either the ▽ or △ button to select SCHEDULE. 2. Press Enter. The SCHEDULE menu opens. 3. Choose SET CLOCK and then press Enter. The SET Clock menu opens. 	 

Set the time and date (continued)

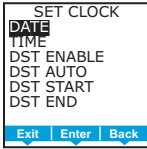
Procedure	Steps	Display
<p>Choose a clock function to set.</p>	<p>Choose one of the features in the SET CLOCK menu to change the date, time, or Daylight Saving Time (DST) setting.</p> <ul style="list-style-type: none"> ◆ DATE—The current calendar date. ◆ TIME—Time is set according to a 12-hour clock. ◆ DST ENABLE—Set to TRUE to enable Daylight Saving Time and FALSE to use standard time year around. ◆ DST AUTO—When set to TRUE, the AppStat automatically calculates the start and end dates from relative dates. For example, set DST START to the first Sunday in March instead of a calendar date. ◆ DST START and DST END—Enter the dates and time to begin observing DST. If DST AUTO is set to TRUE the dates are relative; if set to FALSE the date is a calendar date. 	

Setting the occupancy schedule



The schedule in the AppStat controls the occupancy mode. If the schedule is set to ON, the AppStat uses the occupied setpoint as the active setpoint. If the schedule is OFF, the unoccupied setpoint is used.

Note: The schedule in the AppStat is a BACnet schedule object. If the AppStat is connected to a BACnet network the schedule can be set up with a BACnet operator workstation.

Setting the occupancy schedule requires entering Password 2 which is described in the topic [Enter the commissioning mode on page 34](#).

To change the time and date, see the procedure [Set the time and date on page 38](#).

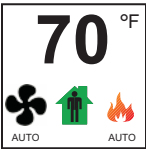
Set up schedules

Procedure	Steps	Display
Starting display	<ol style="list-style-type: none"> 1. Start at the temperature display. 2. Enter Password 2. The display changes to the MAIN menu display. 	 
Select the SCHEDULE menu.	<ol style="list-style-type: none"> 1. From the MAIN menu , press either the ▽ or △ button to select SCHEDULE. 2. Press Enter. The SCHEDULE menu opens. 	

Set up schedules (continued)

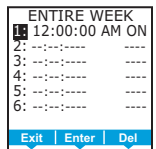
Procedure	Steps	Display
Choose and set a weekly schedule.	<ol style="list-style-type: none"> From the SCHEDULE menu, choose one of the following schedule entry methods to enter a weekly schedule. <ul style="list-style-type: none"> ENTIRE WEEK—Sets the schedule for all seven days of the week at one time. WEEKDAYS—Sets the schedule for Monday to Friday. Saturday and Sunday are not changed WEEKEND—Sets the schedule for Saturday and Sunday. Monday to Friday remain unchanged. INDIVIDUAL DAYS—Sets the schedule for just the selected day of the week. Change the daily times and values in the schedule to set the occupancy mode to either ON or OFF. <ul style="list-style-type: none"> When finished with each pair push Enter or Done. When finished with the schedule push Exit to return to the SCHEDULE menu. 	 

Set up schedules (continued)

Procedure	Steps	Display
Choose and set a holiday schedule	<p>Use a holiday schedule to override the values in the weekly schedule. Months and years can be entered as follows:</p> <ul style="list-style-type: none"> ◆ To choose ANY as the year, select the year and push the down arrow ▾ past the current year ◆ For month the choices are any of the twelve months of the year, ANY, EVEN, and ODD. <ol style="list-style-type: none"> 1. From the SCHEDULE menu, choose HOLIDAYS. 2. From the HOLIDAYS list, choose a holiday to edit. 3. From the menu for the holiday, choose <ul style="list-style-type: none"> • DATE—Enter a single date on which the holiday schedule will override the values of the weekly schedule. • DATE RANGE—Enter a range of dates on which the values and times listed in the holiday schedule will override the values of the weekly schedule. • WEEK N DAY—A day of the week and month on which the values and times listed in the holiday schedule will override the values of the weekly schedule. 	 <p>The display shows four sequential screens from the HOLIDAYS menu:</p> <ul style="list-style-type: none"> Screen 1: A list of holiday options labeled HOLIDAYS, HOLIDAYS, HOLIDAYS, HOLIDAYS, HOLIDAYS, HOLIDAYS, and HOLIDAYS. At the bottom are buttons for Exit, Enter, and Del. Screen 2: Shows HOLIDAYS HOLIDAYS. Fields include DATE: DEC 12 2013 and TYPE: DATE. At the bottom are buttons for Exit, Enter, and Del. Screen 3: Shows HOLIDAYS HOLIDAYS. Fields include START DATE: NOV 27 2013, END DATE: DEC 12 2013, and TYPE: DATE RANGE. At the bottom are buttons for Exit, Enter, and Del. Screen 4: Shows HOLIDAYS HOLIDAYS. Fields include MON WK DAY: OCT 31 THU and TYPE: WEEK N DAY. At the bottom are buttons for Exit, Enter, and Del.



Set fan coil unit system options

The items in the system menu control application specific functions for fan coil units. Entering the system options requires entering Password 2 which is described in the topic [Enter the commissioning mode on page 34](#).

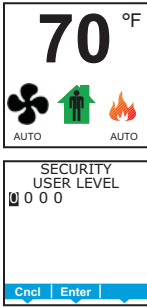
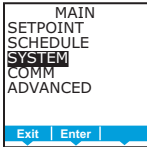
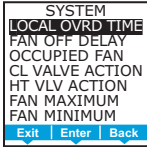
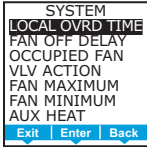
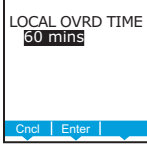
Set up fan coil unit system options

Procedure	Steps	Display
Starting display.	<ol style="list-style-type: none"> 1. Start at the temperature display. 2. Enter Password 2. The display changes to the MAIN menu display. 	 <p>The display shows a temperature of 70°F with a fan icon on the left and a flame icon on the right, both labeled 'AUTO'. Below this is a 'SECURITY USER LEVEL' screen showing '000' and navigation buttons 'Cncl' and 'Enter'.</p>
Choose and set the fan coil system options.	<ol style="list-style-type: none"> 1. From the MAIN menu , press either the ▽ or △ button to select SYSTEM. 2. Press Enter. The SYSTEM menu opens. 3. Choose any of the following items. <ul style="list-style-type: none"> ◆ LOCAL OVRD TIME ◆ FAN OFF DELAY ◆ OCCUPIED FAN ◆ CL VALVE ACTION (Four-pipe only) ◆ HT VLV ACTION (Four-pipe only) ◆ VLV ACTION (Two-pipe only) ◆ FAN MAXIMUM (Modulating fans only) ◆ FAN MINIMUM (Modulating fans only) ◆ FAN SPEEDS (Three speed fans only) ◆ AUX HEAT (Two-pipe only) 	   <p>The first display shows the 'MAIN' menu with 'SYSTEM' highlighted. The second and third displays show the 'SYSTEM' menu with 'LOCAL OVRD TIME' highlighted. Navigation buttons 'Exit', 'Enter', and 'Back' are visible at the bottom of each menu.</p>
Set the local override time.	From the SYSTEM menu choose LOCAL OVRD TIME to set the time the AppStat will hold an override temperature setpoint as the active setpoint. At the end of the period, the AppStat will use either an occupied or unoccupied setpoint as the active setpoint.	 <p>The display shows 'LOCAL OVRD TIME' with '60 mins' set. Navigation buttons 'Cncl', 'Enter', and 'Back' are at the bottom.</p>

Set up fan coil unit system options (continued)

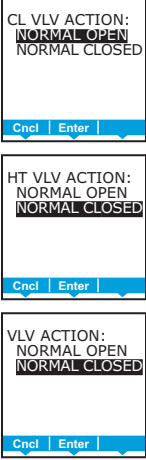
Procedure	Steps	Display
Set the fan delay.	From the SYSTEM menu choose FAN DELAY OFF to set the time the system fan will continue to run after the last heating or cooling stage is turned off.	
Set the occupied fan control.	From the SYSTEM menu choose OCCUPIED FAN to choose the following: <ul style="list-style-type: none"> ◆ When ON, the fan will run continuously when the schedule is occupied (On). ◆ When the schedule is unoccupied (Off) the fan will run only when there is a call for heating or cooling. 	
Set the valve action.	Select one of the valve actions from the SYSTEM menu. Not all choices apply to every application. <ul style="list-style-type: none"> ◆ CL VALVE ACTION—(Four-pipe only) ◆ HT VLV ACTION—(Four-pipe only) ◆ VLV ACTION—(Two-pipe only) Valve action selections are the same for all three types of valves. <ul style="list-style-type: none"> ◆ NORMAL OPEN—The valve changes from fully open to fully closed as the AppStat varies the valve output from 0 to 10 volts. ◆ NORMAL CLOSED—The valve changes from fully closed to fully open as the AppStat varies the valve output from 0 to 10 volts. 	



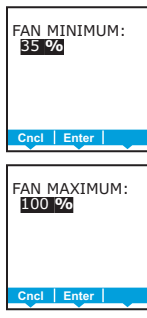
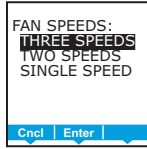
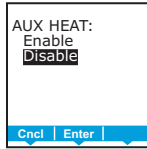



Set up fan coil unit system options (continued)

Procedure	Steps	Display
<p>Set fan speeds for modulating speed fans.</p>	<p>Select FAN MINIMUM or FAN MAXIMUM from the SYSTEM menu to set fan speed for modulation fans.</p> <ul style="list-style-type: none"> ◆ FAN MINIMUM—Sets the slowest speed at which the fan will run when a user sets the fan speed to LOW. ◆ FAN MAXIMUM—Sets the fastest speed at which the fan will run when a user sets the fan speed to HIGH. ◆ The MED speed is automatically set halfway between the LOW and HIGH settings. 	
<p>Set fan speeds for three-speed fans.</p>	<p>Select FAN SPEEDS from the SYSTEM menu to designate the number of speeds at which the installed fan will run.</p>	
<p>Enable axillary heat</p>	<p>Choose AUX HEAT from the SYSTEM menu to enable axillary heat in two-pipe applications.</p>	

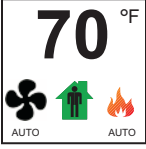

Set roof top unit system options

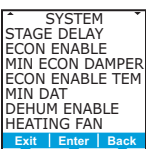
The items in the system menu control application specific functions for roof top units. Entering the system options requires entering Password 2 which is described in the topic [Enter the commissioning mode on page 34](#).

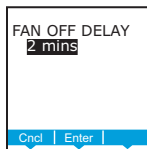
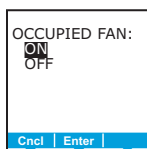

Set up roof top unit system options

Procedure	Steps	Display
Starting display.	<ol style="list-style-type: none"> Start at the temperature display. Enter Password 2. The display changes to the MAIN menu display. 	 
Choose and set the roof top system options.	<ol style="list-style-type: none"> From the MAIN menu , press either the ▽ or △ button to select SYSTEM. Press Enter. The SYSTEM menu opens. Choose any of the following items. <ul style="list-style-type: none"> ◆ LOCAL OVRD TIME ◆ FAN DELAY OFF ◆ OCCUPIED FAN ◆ MIN OFF TIME ◆ STAGE DELAY ◆ ECON ENABLE ◆ MIN ECON DAMPER ◆ ECON ENABLE TEM ◆ MIN DAT ◆ HEATING FAN 	  
Set the local override time.	From the SYSTEM menu choose LOCAL OVRD TIME to set the time the AppStat will hold an override temperature setpoint as the active setpoint. At the end of the period, the AppStat will use either an occupied or unoccupied setpoint as the active setpoint.	

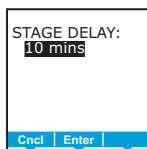
Set up roof top unit system options (continued)

Procedure	Steps	Display
Set the fan delay.	From the SYSTEM menu choose FAN DELAY OFF to set the time the system fan will continue to run after the last heating or cooling stage is turned off.	
Set the occupied fan control.	From the SYSTEM menu choose OCCUPIED FAN to choose the following: <ul style="list-style-type: none"> ◆ When ON, the fan will run continuously when the AppStat schedule is ON (occupied). ◆ When the AppStat schedule is OFF (Unoccupied) the fan will run only when there is a call for heating or cooling. 	
Set up staged cooling and heating.	To set up staged cooling and heating do the following: <ol style="list-style-type: none"> 1. From the SYSTEM menu choose MIN OFF TIME to enter the time a stage must remain turned off before it can be turned on again. 2. From the SYSTEM menu choose STAGE DELAY to enter the time the first stage must remain turned on before the second stage can be turned on. 	 

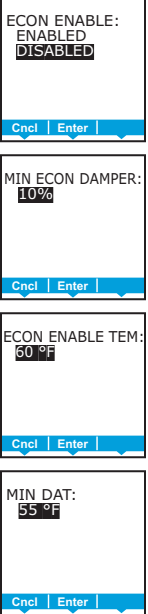

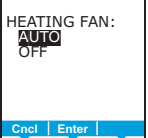

Set up roof top unit system options (continued)

Procedure	Steps	Display
<p>Enable the economizer. (Optional feature)</p>	<p>The economizer feature is an option and not available on all models.</p> <p>To set up the economizer do the following:</p> <ol style="list-style-type: none"> 1. From the SYSTEM menu choose ECON ENABLE to enable the economizer application. 2. From the SYSTEM menu choose MIN ECON DAMPER to set the minimum position for the economizer damper. 3. From the SYSTEM menu choose ECON ENABLE TEM. Enter the value that the outside air temperature must fall below before the economizer damper can open. 4. From the SYSTEM menu choose MIN DAT. Enter the minimum discharge air temperature that will be allowed during cooling when the economizer is enabled. 	 <p>The display shows four sequential screens for setting the economizer. Each screen has a 'Cncl' button on the left and an 'Enter' button on the right.</p> <ul style="list-style-type: none"> Screen 1: ECON ENABLE: ENABLE / DISABLED Screen 2: MIN ECON DAMPER: 10% Screen 3: ECON ENABLE TEM: 60 °F Screen 4: MIN DAT: 55 °F
<p>Enable dehumidification. (Optional feature)</p>	<p>From the SYSTEM menu choose DEHUM ENABLE to enable or disable dehumidification. Dehumidification is only available on models with a humidity sensor.</p>	 <p>The display shows a screen for setting dehumidification. It has a 'Cncl' button on the left and an 'Enter' button on the right.</p> <ul style="list-style-type: none"> Screen: DEHUM ENABLE: ENABLE / DISABLED
<p>Set heating fan control.</p>	<p>From the SYSTEM menu choose HEATING FAN and then choose one for the following.</p> <ul style="list-style-type: none"> ♦ AUTO—The fan runs only on a call for heat. ♦ OFF—The AppStat will not command the fan to run. Typically this setting used for systems with baseboard heat or some similar split system configuration. 	 <p>The display shows a screen for setting heating fan control. It has a 'Cncl' button on the left and an 'Enter' button on the right.</p> <ul style="list-style-type: none"> Screen: HEATING FAN: AUTO / OFF

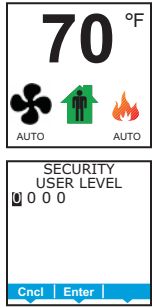

Set heat pump unit system options

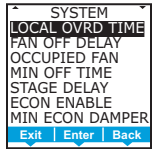
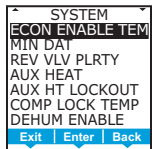
The items in the system menu control application specific functions for heat pump units. Entering the system options requires entering Password 2 which is described in the topic [Enter the commissioning mode on page 34](#).



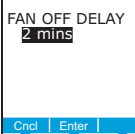
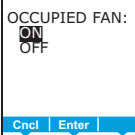

Set up heat pump unit system options

Procedure	Steps	Display
Starting display.	<ol style="list-style-type: none"> 1. Start at the temperature display. 2. Enter Password 2. The display changes to the MAIN menu display. 	
Choose and set the heat pump system options.	<ol style="list-style-type: none"> 1. From the MAIN menu , press either the ▽ or △ button to select SYSTEM. 2. Press Enter. The SYSTEM menu opens. 3. Choose any of the following items. <ul style="list-style-type: none"> ◆ LOCAL OVRD TIME ◆ FAN OFF DELAY ◆ OCCUPIED FAN ◆ MIN OFF TIME ◆ STAGE DELAY ◆ ECON ENABLE (optional) ◆ MIN ECON DAMPER (optional) ◆ ECON ENABLE TEM (optional) ◆ MIN DAT (optional) ◆ REV VLV PLRTY ◆ AUX HEAT (optional) ◆ AUX HT LOCKOUT (optional) ◆ COMP LOCK TEMP ◆ DEHUM ENABLE (optional) 	  
Set the local override time.	From the SYSTEM menu choose LOCAL OVRD TIME to set the time the AppStat will hold an override temperature setpoint as the active setpoint. At the end of the period, the AppStat	

Set up heat pump unit system options (continued)

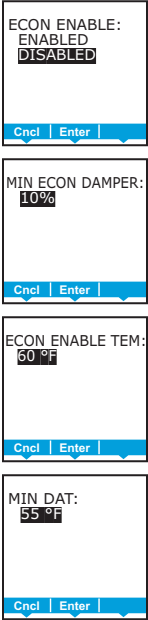
Procedure	Steps	Display
	<p>will use either an occupied or unoccupied setpoint as the active setpoint.</p>	
Set the fan delay.	<p>From the SYSTEM menu choose FAN DELAY OFF to set the time the system fan will continue to run after the last heating or cooling stage is turned off.</p>	
Set the occupied fan control.	<p>From the SYSTEM menu choose OCCUPIED FAN to choose the following:</p> <ul style="list-style-type: none"> ◆ When ON, the fan will run continuously when the AppStat schedule is ON (occupied). ◆ When the AppStat schedule is OFF (Unoccupied) the fan will run only when there is a call for heating or cooling. 	
Set up staged cooling and heating.	<p>To set up staged cooling and heating do the following:</p> <ol style="list-style-type: none"> 1. From the SYSTEM menu choose MIN OFF TIME to enter the time a stage must remain turned off before it can be turned on again. 2. From the SYSTEM menu choose STAGE DELAY to enter the time the first stage must remain turned on before the second stage can be turned on. 	 

Set up heat pump unit system options (continued)

Procedure	Steps	Display
<p>Enable the economizer. (Optional feature)</p>	<p>The economizer feature is an option and not available on all models.</p> <p>To set up the economizer do the following:</p> <ol style="list-style-type: none"> 1. From the SYSTEM menu choose ECON ENABLE to enable the economizer application. 2. From the SYSTEM menu choose MIN ECON DAMPER to set the minimum position for the economizer damper. 3. From the SYSTEM menu choose ECON ENABLE TEM. Enter the value that the outside air temperature must fall below before the economizer damper can open. 4. From the SYSTEM menu choose MIN DAT. Enter the minimum discharge air temperature that will be allowed during cooling when the economizer is enabled. 	
<p>Set the reversing valve polarity.</p>	<p>From the SYSTEM menu choose REV VLV PLRTY. Select one of the polarity settings.</p> <ul style="list-style-type: none"> ◆ Active Heating—The O/B output terminal is active on a call for heating. ◆ Active Cooling—The O/B output terminal is active on a call for cooling. 	
<p>Set up auxiliary heat. (Optional feature)</p>	<p>From the SYSTEM menu choose AUX HEAT.</p> <ul style="list-style-type: none"> ◆ Comp Lockout—The AppStat will enable auxiliary heat only when the compressors are locked out because of low outside air temperature. ◆ 3rd Stage—The AppStat uses the auxiliary heat as a third stage of heating. ◆ None—No auxiliary heat is enabled. 	
<p>Set the lockout temperature for auxiliary heat.</p>	<p>From the SYSTEM menu choose AUX HT LOCKOUT to set the minimum outside air temperature for auxiliary heat lockout. Auxiliary heat will not operate above this temperature.</p>	

Set up heat pump unit system options (continued)

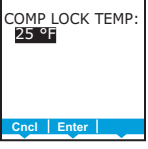
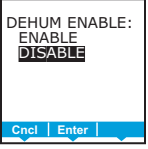
Procedure	Steps	Display
Set the compressor low temperature lockout.	From the SYSTEM menu choose COMP LOCK TEMP to set the minimum outside air temperature for compressor operation. Compressors will not operate below this temperature.	 <p>COMP LOCK TEMP: 25 °F Cncl Enter</p>
Enable dehumidification. (Optional feature)	From the SYSTEM menu choose DEHUM ENABLE to enable or disable dehumidification. Dehumidification is only available on models with a humidity sensor and auxiliary heat is enabled.	 <p>DEHUM ENABLE: ENABLE DISABLE Cncl Enter</p>

Advanced options

Use the advanced options to set up the following items.

- ◆ Choosing an application and units of measure.
- ◆ Adjusting the PID loops
- ◆ Changing passwords
- ◆ Calibrating inputs
- ◆ Setting the display blanking
- ◆ Modifying access to users with Password 1.

Setting the advance options requires entering Password 2 which is described in the topic [Enter the commissioning mode on page 34](#).

Choosing advance options

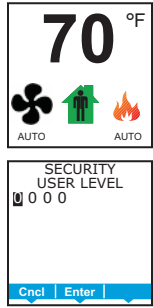
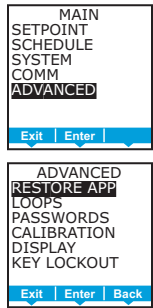
Procedure	Steps	Display
Starting display.	<ol style="list-style-type: none"> 1. Start at the temperature display. 2. Enter Password 2. The display changes to the MAIN menu display. 	
Choose the ADVANCED menu.	<ol style="list-style-type: none"> 1. From the MAIN menu , press either the ▽ or △ button to select ADVANCED. 2. Press Enter. The ADVANCED menu opens. 3. Choose any of the following functions. <ul style="list-style-type: none"> ◆ RESTORE APP ◆ LOOPS ◆ PASSWORDS ◆ CALIBRATION ◆ DISPLAY ◆ KEY LOCKOUT 	

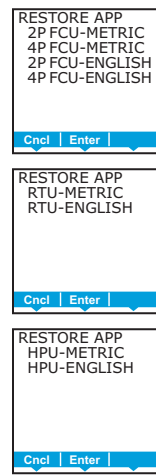
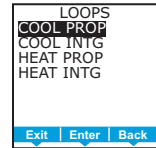

Choosing advance options (continued)

Procedure	Steps	Display
<p>Reset the application and choose units of measure.</p>	<p>Choose RESTORE APP from the ADVANCED menu to reset the AppStat to the original configuration and settings. Use it also to change the AppStat application program and the units of measure to display. There are two versions of each application program in every AppStat.</p> <ul style="list-style-type: none"> ◆ The Metric version displays temperature in Celsius and uses metric values for units of measure. ◆ The English version displays temperature in Fahrenheit and uses English values for units of measure. <p>Note: Choosing an application will reset the AppStat.</p>	
<p>Adjust the PID loops.</p>	<p>Choose LOOPS from the ADVANCED menu to adjust the values for the cooling or heating PID loops. Only the proportional and integral properties can be changed from the display.</p> <ul style="list-style-type: none"> ◆ The proportional default is 2° F. ◆ The integral default is zero (0). 	

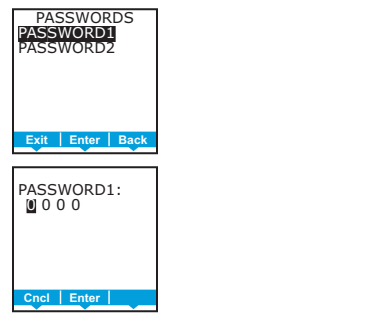
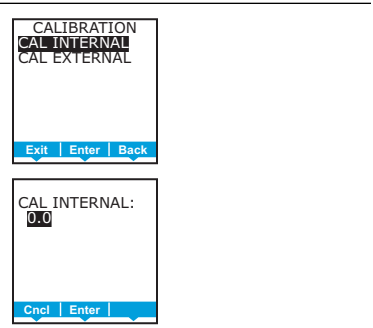
Choosing advance options (continued)

Procedure	Steps	Display
<p>Enter or change passwords.</p>	<p>Choose PASSWORDS from the ADVANCED menu to set either Password 1 or Password 2.</p> <ul style="list-style-type: none"> ◆ Password 1 is for a facility user and limits changes to active setpoints, fan operation, occupancy, and heating and cooling modes. ◆ Password 2 is for a controls technician to set up and commission the AppStat. <p>Note: Entering four zeros (0000) removes the password. The AppStat is supplied without passwords.</p> <ol style="list-style-type: none"> 1. From the PASSWORD1 or PASSWORD2 menu press either the ▽ or △ buttons to change the first digit of the password. 2. Press the Enter button to select the next digit. Repeat for all four digits. 3. When the Enter button is pressed for the last digit, the new password is saved and the display advances. 	
<p>Calibrate the inputs.</p>	<p>Choose CALIBRATION from the ADVANCED menu to calibrated an input. The AppStat includes two calibration entries; one for the internal temperature sensor and one for the optional remote temperature sensor connected to the RS terminal.</p> <p>Enter a calibration factor to adjust either input for sensor inaccuracies.</p> <ul style="list-style-type: none"> ◆ For a low input reading enter a positive correction value. ◆ For a high input reading enter a negative correction value. 	

Choosing advance options (continued)

Procedure	Steps	Display
Set the display blanking.	<p>Choose DISPLAY from the ADVANCED menu to set the display appearance after the last button is pushed.</p> <ul style="list-style-type: none"> ◆ BLANKING—Choose one of the blanking options. <ul style="list-style-type: none"> • CLOCK—An analog clock replaces the temperature and mode icons. • BACKLIGHT OFF—The display brightness changes to the level set by DIM LEVEL after the last button interaction. • NONE—The temperature and mode icons always remain visible. ◆ DIM LEVEL—Sets the level of brightness of the display back light if BACKLIGHT OFF is the selected blanking option. 	
Lockout user buttons.	<p>Choose KEY LOCKOUT from the ADVANCED menu to limit the accessibility to users with only Password 1, the user password.</p> <ul style="list-style-type: none"> ◆ MODE/SETPOINT—Users with Password 1 cannot change any value or mode. ◆ MODE—Users with Password 1 cannot change the heating/cooling, fan, or occupancy modes. ◆ NONE—Users with Password 1 have full access to active setpoints, heating/cooling, fan, and occupancy modes. 	

Section 5: **Sequences of operation**

Topics in this section cover the sequences of operation for the AppStat. These are advanced topics for control's technicians and engineers.

This section covers the following sequences of operation.

- ◆ *Room temperature setpoints on page 58*
- ◆ *Occupancy on page 59*
- ◆ *Schedules on page 60*
- ◆ *Dehumidification sequence on page 60*
- ◆ *PID control loops on page 60*
- ◆ *Valve operation for fan coil units on page 61*
- ◆ *Fan operation for fan coil units on page 62*
- ◆ *Automatic cooling and heating changeover on page 59*
- ◆ *Modulating cooling and heating for roof top units on page 63*
- ◆ *Staged heating and cooling for roof top and heat pump units on page 63*
- ◆ *Fan control for roof top and heat pump units on page 64*
- ◆ *Economizer cooling for roof top and heat pump units on page 64*
- ◆ *Heat pump unit specific functions on page 65*

Room temperature setpoints

There are four temperature setpoints each for heating and cooling for a total of eight setpoints.

- ◆ Active cooling
- ◆ Occupied cooling
- ◆ Unoccupied cooling
- ◆ Standby cooling
- ◆ Active heating
- ◆ Occupied heating
- ◆ Unoccupied heating
- ◆ Standby heating

Types of setpoints

Active setpoint—The active setpoint is the current setpoint. The active setpoint is determined by the following.

- ◆ If the space is occupied, the controller uses the occupied setpoint.
- ◆ If the space is unoccupied the controller uses the unoccupied setpoint.
- ◆ If controller occupancy is in standby, the controller calculates the standby setpoint.
- ◆ A user with Password 1 can enter an active setpoint from the display. This change is for a limited time or until the next time the space status changes from unoccupied or standby to occupied.

Occupied setpoint—A temperature setpoint entered by the controls technician during controller setup and system commissioning. This is the setpoint used when the system is occupied which is usually controlled by the schedule in the controller.

Unoccupied setpoint—A temperature setpoint entered by the controls technician during controller setup and system commissioning. This is the setpoint used when the system is unoccupied which is usually controlled by the schedule in the controller.

Standby setpoint—The standby setpoint is used when the controller is in the standby state. It is a value calculated from the occupied setpoint and the value of Standby Offset. The standby offset value is entered by the systems technician during controller setup and system commissioning. The standby state is valid only for controllers with motion sensors.

Setpoint limits

No cooling setpoint can be higher than any heating setpoint.

If a user is adjusting a setpoint and it comes within the range set by Minimum Setpoint Differential, the corresponding setpoint will be changed to maintain

the differential. For example, the Minimum Setpoint Differential is 4° F and the Occupied Heating setpoint is 70°. If the user lowers the Occupied Cooling setpoint to 71° F, the controller recalculates the Occupied Heating setpoint and changes it to 67° F.

Occupancy

The AppStat is designed to operate as a stand-alone controller and can determine occupancy based on its internal occupancy schedule and, on models with motion sensors, motion in the space. The AppStat can be in any one of the following occupancy states.

- ◆ Occupied
- ◆ Standby
- ◆ Unoccupied

An occupancy state can also be commanded by another BACnet controller on the building automation network.

Occupied

In controllers without a motion sensor, the AppStat starts in the occupied state. If the internal schedule is enabled, the state of the schedule is set to either occupied or unoccupied as the initial state.

In units with a motion sensor, the controller starts in standby and changes to occupied after detecting motion in the space.

Standby

The standby state is entered automatically for controllers with a motion sensor. A controller with a motion sensor will change from occupied to standby after a lack of motion for the period specified by the variable Standby Time.

Unoccupied

The unoccupied state is entered only if the internal occupancy schedule is enabled and if the schedule is inactive.

Automatic cooling and heating changeover

The AppStat can be set to automatically change between the heating and cooling modes.

- ◆ If the space temperature rises above the active cooling setpoint, the mode is set to cooling.
- ◆ If the space temperature falls below the active cooling setpoint, the mode is set to heating.

Schedules

The internal occupancy schedule changes the AppStat between the occupied (active) and unoccupied (inactive) states. If the AppStat includes a motion sensor, the motion sensor may change the AppStat between occupied and standby based on motion detected in the space.

See also the topic [Occupancy on page 59](#).

Dehumidification sequence

Dehumidification control is available only on models with internal humidity sensors. Dehumidification is not available for fan coil units configured for two-pipe operation.

The AppStat can change to dehumidification only if the heating and cooling mode is set to automatic. The dehumidification sequence can then start if the space humidity rises above the value of Dehumidification Setpoint. Dehumidification stops when the space humidity drops to a value below the Dehumidification Setpoint minus the Dehumidification Deadband. The dehumidification setpoint and deadband are both adjustable from the user interface.

When Dehumidification is active, the cooling is activated to 100%. The heating then reheats the discharge air to maintain the Active Cooling setpoint.

If the fan mode is set to *Auto* during dehumidification the controller runs the fan continuously.

PID control loops

A PID control loop calculates an error value from the difference between the measured room temperature and the active setpoint. The error value is expressed as a percentage and is typically used in a BAS controller to control the state of an output. When the difference between the setpoint and room temperature is large, the error is large. As the system reduces the difference between the setpoint and space temperature, the error becomes smaller. In a simple example, if the output of the PID loop that is controlling a modulating valve is 50% the valve would be opened half way; if the output of the loop is 100% the valve position is fully open.

The AppStat heating and cooling PID loops are implemented in all models.

The AppStat also uses two other PID loops, the discharge air temperature loop and the reheat loop. The discharge air loop controls the position of the economizer. For this loop the setpoint is the measured temperature of the air that is discharged by a roof top or heat pump unit. The reheat loop is used only in heat pump units and controls the auxiliary heat unit during dehumidification.

The PID loops in the AppStat are standard BACnet objects.

Valve operation for fan coil units

Hot and chilled water valves are used for heating and cooling in the fan coil unit versions of the AppStat. The two-pipe programming includes a method to determine supply water temperature.

On/Off valves

On a call for cooling or heating, the valve will open once the loop controlling the valve has reached 50%. The valve will close once the loop has fallen to 5%.

- ◆ Normal—The valve is closed when the output is inactive and open when the output is active.
- ◆ Reverse—The valve is closed when the output is active and open when the output is inactive.

Modulating valves

On a call for cooling or heating, a modulating valve will modulates from 0 to 100% over the first half (0 to 50%) of the PID loop output controlling the valve. The AppStat supports both normal and reverse action which can be set from the user interface.

- ◆ Normal—The valve is fully closed when the output signal is 0 volts and fully open when the output is 10 volts DC.
- ◆ Reverse—The valve is fully closed when the output signal is 10 volts and fully open when the output is 0 volts DC.

Two-pipe water supply temperature evaluation

For two-pipe fan coil units, the AppStat uses the water supply temperature sensor, input WST, to determine if chilled or hot water is being supplied to the unit. The water type is determined by comparing the value of the water temperature sensor input to the room temperature. The AppStat programming then determines that the water temperature is one of the following.

- ◆ Chilled—the water temperature is 10° F below room temperature.
- ◆ Hot—the water temperature is 10° F above room temperature.
- ◆ None—the water temperature is within 7° F of room temperature.

If the water temperature is evaluated as None, the AppStat runs the water evaluation program every six hours. During a water evaluation, the AppStat opens the valve until a water type is determine or for five minutes, whichever is reached first. If a water evaluation is not being performed, the valve remains closed.

The supply water type is stored in multistate variable Water Available.

Fan operation for fan coil units

The AppStat has two parts to fan operation.

- ◆ Automatic fan control can be controlled from the user interface by a user with Password 1.
- ◆ Fan speed is set up during commissioning by a user with Password 2.

Automatic fan control

A user with Password 1 can set the AppStat controlled fan to either run continuously or to start automatically on a call for cooling or heating.

Auto—When Auto is selected, the fan runs only when there is a call for cooling or heating. It continues to run after the call for cooling or heating for the period set by the fan delay timer.

On—The fan will run continuously regardless of the heat/cool modes or occupied/standby states.

Low, Medium, High—For systems with three-speed fans, the user has the choice of low, medium or high speed as the continuous running speed.

Fan speed setup

The AppStat can control either variable speed fans or fans with up to three speeds. Fans speed control is set up from the user interface by a user with Password 2.

One, two, and three speed fans The fan outputs are energized as the cooling or heating loop varies from 0-100%. The fan always starts as soon as a cooling or heating valve is active.

Table 5-1 Fan speed

	Output terminal	Fan L		Fan M		Fan H	
Fan speed		Off	On	On	Off	On	Off
One		5%	Active valve	n/a	n/a	n/a	n/a
Two		5%	Active valve	n/a	n/a	95%	80%
Three		5%	Active valve	65%	50%	95%	80%

Modulating fans The fan starts on a call for either heating or cooling. The fan runs at the minimum fan speed until the heating or cooling loop reaches 50%. From 50% to 100% of the loop, the fan speed ramps from the minimum

speed to maximum speed. The minimum and maximum fan speeds are set from the user interface during system setup.

Modulating cooling and heating for roof top units

Modulating cooling and heating is used in AppStat controlled systems with modulating valves and chilled or hot water coils. A single modulating valve can be used with staged cooling or heating.

Cooling

Modulating cooling does not start until the cooling loop reaches 100%. Once the loop reaches 100%, the analog cooling output modulates over 10 volts DC as the cooling loop changes from 0 to 100%. When the cooling loop returns to 0%, cooling stops until the loop again reaches 100%.

If the economizer is enabled, cooling will not start modulating until the economizer damper is fully open.

Heating

Modulating heating does not start until the heating loop reaches 100%. Once the loop reaches 100%, the analog heating output modulates over 10 volts DC as the heating loop changes from 0 to 100%. When the heating loop returns to 0%, heating stops until the loop reaches 100% again.

Valve action

The AppStat supports both normal and reverse valve action that can be set from the user interface.

- ◆ Normal—The valve is fully closed when the output signal is 0 volts and fully open when the output is 10 volts DC.
- ◆ Reverse—The valve is fully closed when the output signal is 10 volts and fully open when the output is 0 volts DC.

Staged heating and cooling for roof top and heat pump units

Staged heating and cooling is used for applications other than chilled or hot water systems. Typically the AppStat controls gas heat, electric heat, or direct expansion (DX) cooling with staged heating and cooling. Staged cooling or heating can be mixed with a modulating valve for cooling or heating.

Staged cooling

As the demand for cooling increases, the AppStat starts the first stage of cooling when the cooling PID loop rises above 95% *and* the first stage of cooling has been turned off for at least the time set by the value of MINIMUM OFF TIME. The second stage of cooling is turned on when the cooling loop rises above 99% *and* the first stage has been turned on for the

period set by STAGE DELAY *and* the second stage has been turned off for at least as long as the value of MINIMUM OFF TIME.

As the demand for cooling is satisfied, the second stage is turned off when the cooling PID loop drops below 50%. This first stage is turned off when the cooling loop drops below 5%.

Staged heating

As the demand for heating increases, the AppStat starts the first stage of heating when the heating PID loop rises above 95%. The second stage of heating is turned on when the heating loop rises above 99% *and* the first stage has been turned on for period set by STAGE DELAY.

As the demand for heating is satisfied, the second stage is turned off when the heating PID loop drops below 50%. This first stage is turned off when the heating loop drops below 5%.

Fan control for roof top and heat pump units

A user with Password 1 can set the AppStat controlled fan to either run continuously or to start automatically on a call for cooling or heating.

Auto—When Auto is selected, the fan runs only when there is a call for heating or cooling. It continues to run for the period set by the fan delay timer after the call for heating or cooling.

On—The fan will run continuously regardless of the heat/cool modes or occupied/standby states.

Economizer cooling for roof top and heat pump units

Some models of the AppStat include programming for an economizer. This programming controls an economizer outside air damper connected to the output terminal (ECON).

Note:

The optional economizer can be enabled only if outside air temperature *and* discharge air temperature sensors are connected to the AppStat.

The optional economizer mode is enabled for cooling when the outside air temperature (OAT) is 2° F below the value of the limit set by Economizer Enable Temperature and disabled if the OAT is 2° F above the value of Economizer Enable Temperature.

Once enabled, the economizer outside air damper opens to the larger value of either the minimum damper position limit (Minimum Econ Damper) or the Discharge Air Temperature loop. The Discharge Air Temperature loop modulates from 0% to 100% as the Discharge Air Temperature rises above the Discharge Air Temperature setpoint. The Discharge Air Temperature setpoint resets between room temperature and the limit for minimum discharge air temperature as the cooling loop varies between 0 and 50%. If the Discharge

Air Temperature decreases below 55° F, the Outside Air Damper returns to the minimum damper position.

Heat pump unit specific functions

The heat pump unit fan and staging is similar to the roof top unit fan and staging principles. See the topics *Staged heating and cooling for roof top and heat pump units* on page 63 and *Fan control for roof top and heat pump units* on page 64.

Reversing valve action

The AppStat reversing valve output (O/B) is energized on a call for cooling ('O' function). The action can be changed from the user interface to be active on a call for heating ('B' function). The 'O' function is the default.

Auxiliary or emergency heat action

The heat pump unit AUX/E output is for axillary or emergency heat. Operation can be configured for one of three modes.

Compressor lockout —The AUX/E output is active only on a call for heating when the compressors are locked out because the outside air temperature has dropped below the value of the Compressor OAT Low Limit. The lockout is cleared when the outside air temperature rises 2°F above the value of Compressor OAT Low Limit.

Third stage—The AUX/E output functions as the output for a third stage of heat.

None— This function is a manual operation that can only be turned on from the user interface. When emergency heat is turned on, the AUX/E output is used to maintain the active heating setpoint and both compressor outputs are locked-out.

Section 6: **Application drawings**

This section covers the drawings, materials, and instructions for specific AppStat applications.

Each AppStat model is designed for a specific application. The following topics are for control technicians and engineers that will plan and install AppStat controllers for the following applications.

- ◆ *Fan Coil Unit applications on page 68*
- ◆ *Roof Top Unit applications on page 84*
- ◆ *Heat Pump Unit applications on page 92*

Fan Coil Unit applications

This section covers applications for fan coil units. For other applications see [Roof Top Unit applications on page 84](#) or [Heat Pump Unit applications on page 92](#).

Fan Coil Unit—Four-pipe with three-speed fan and on/off valves

This application applies to models BAC-4001CW0001, BAC-4021CW0001, BAC-4201CW0001, and BAC-4221CW0001.

- ◆ Fan status switch (FST) and discharge air temperature sensor (DAT) are optional. They are typically used only when the AppStat is connected to a network.
- ◆ For dehumidification, the AppStat must include a humidity sensor.
- ◆ The remote temperature sensor (RS) is optional.
- ◆ Valves are 24 Volt AC.
- ◆ Fan outputs are for 24 volt AC pilot duty inputs.
- ◆ For additional details on connecting sensors, see [Connecting inputs on page 18](#).
- ◆ For additional detail on connecting the fan and valves, see [Connecting outputs on page 21](#).

Table 6–1 Materials list

KMC Part No.	Description	Function
CSE-1102	Differential Pressure Switch, Barb Fittings	Fan status switch
STE-6011W10	Temperature sensor, 10kΩ Type II	Remote space temperature
STE-1405	Duct temperature sensor, 10kΩ Type III	Discharge air temperature
XEE-6111-040	Single-hub 120 volt power transformer	Controls transformer
XEE-6112-040	Dual-hub 120 volt power transformer	
XEE-6311-075	120/240/277/480VAC, 24 VAC, 75 VA transformer	

Illustration 6-1 Wiring details: Four-pipe FCU with on/off valves

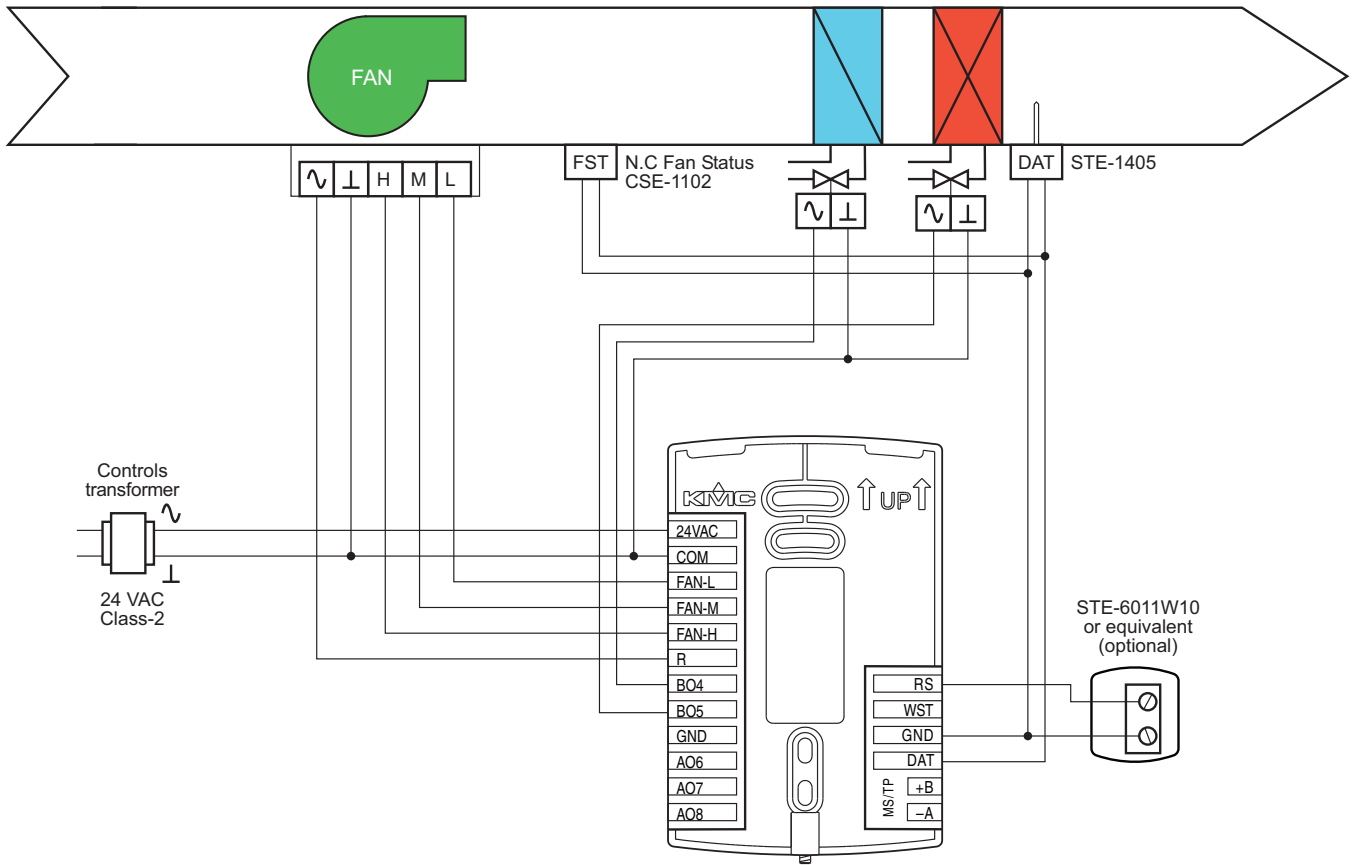

Fan Coil Unit—Four-pipe with three-speed fan and modulating valves

This application applies to models BAC-4002CW0001, BAC-4022CW0001, BAC-4202CW0001, and BAC-4222CW0001.

- ◆ Fan status switch (FST) and discharge air temperature sensor (DAT) are optional. They are typically used only when the AppStat is connected to a network.
- ◆ For dehumidification, the AppStat must include a humidity sensor.
- ◆ The remote temperature sensor (RS) is optional.
- ◆ Valves are 24 Volt AC with a 0–10 Volt DC control signal.
- ◆ Fan outputs are for 24 volt AC pilot duty inputs.
- ◆ For additional details on connecting sensors, see [Connecting inputs on page 18](#).
- ◆ For additional detail on connecting the fan and valves, see [Connecting outputs on page 21](#).

Table 6–2 Materials list

KMC Part No.	Description	Function
CSE-1102	Differential Pressure Switch, Barb Fittings	Fan status switch
STE-6011W10	Temperature sensor, 10kΩ Type II	Remote space temperature
STE-1405	Duct temperature sensor, 10kΩ Type III	Discharge air temperature
XEE-6111-040	Single-hub 120 volt power transformer	Controls transformer
XEE-6112-040	Dual-hub 120 volt power transformer	
XEE-6311-075	120/240/277/480VAC, 24 VAC, 75 VA transformer	

Illustration 6-2 Wiring details: Four pipe FCU with three-speed fan and modulating valves

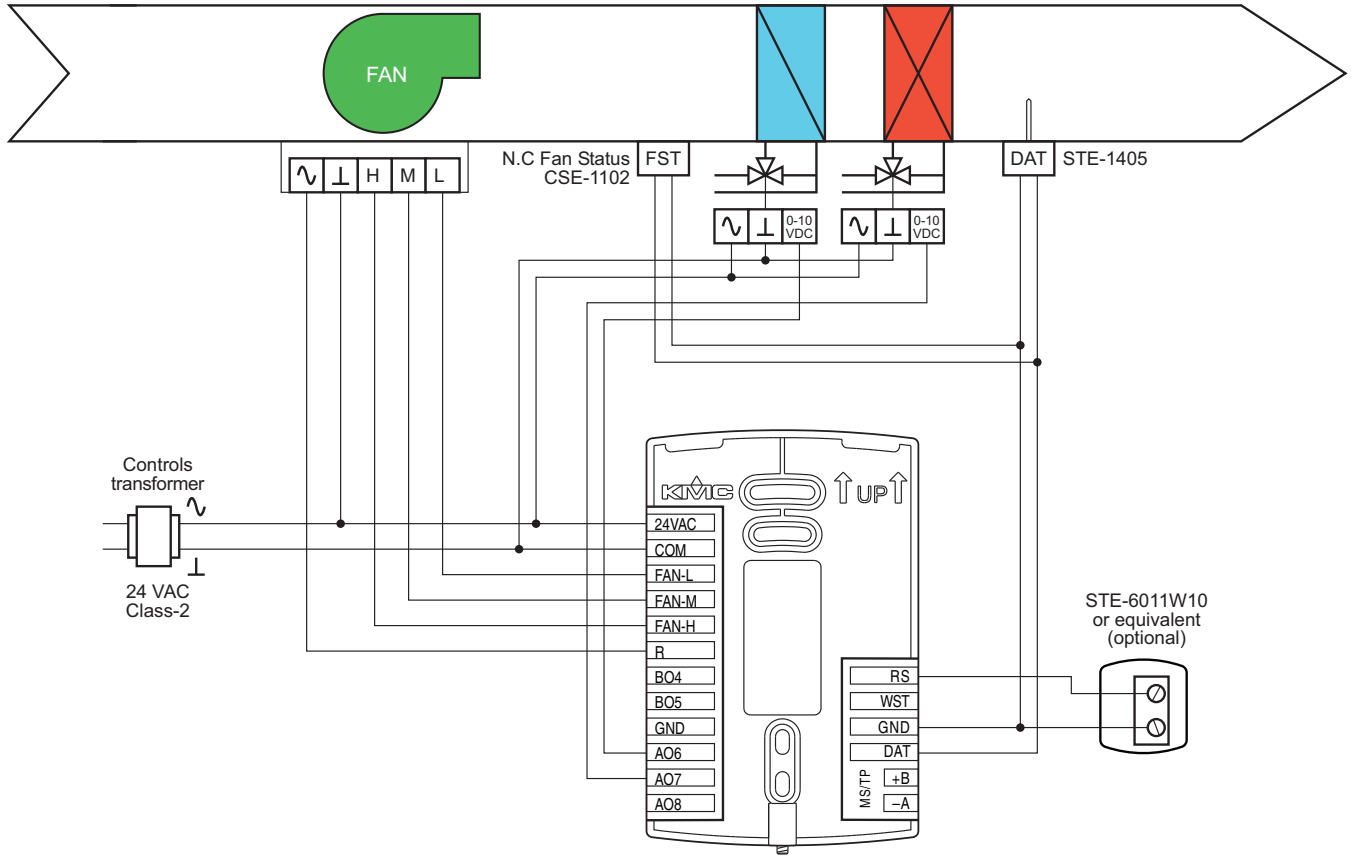

Fan Coil Unit—Four-pipe with modulating fan and on/off valves

This application applies to models BAC-4007CW0001, BAC-4027CW0001, BAC-4207CW0001, and BAC-4227CW0001.

- ◆ Fan status switch (FST) and discharge air temperature sensor (DAT) are optional. They are typically used only when the AppStat is connected to a network.
- ◆ For dehumidification, the AppStat must include a humidity sensor.
- ◆ The remote temperature sensor (RS) is optional.
- ◆ Valves are 24 Volt AC.
- ◆ Fan starting input is 24 volt AC pilot duty.
- ◆ Fan speed input is 0-10 volts DC.
- ◆ For additional details on connecting sensors, see [Connecting inputs on page 18](#).
- ◆ For additional detail on connecting the fan and valves, see [Connecting outputs on page 21](#).

Table 6–3 Materials list

KMC Part No.	Description	Function
CSE-1102	Differential Pressure Switch, Barb Fittings	Fan status switch
STE-6011W10	Temperature sensor, 10kΩ Type II	Remote space temperature
STE-1405	Duct temperature sensor, 10kΩ Type III	Discharge air temperature
XEE-6111-040	Single-hub 120 volt power transformer	Controls transformer
XEE-6112-040	Dual-hub 120 volt power transformer	
XEE-6311-075	120/240/277/480VAC, 24 VAC, 75 VA transformer	

Illustration 6-3 Wiring details: Four-pipe FCU with modulating fan and on/off valves

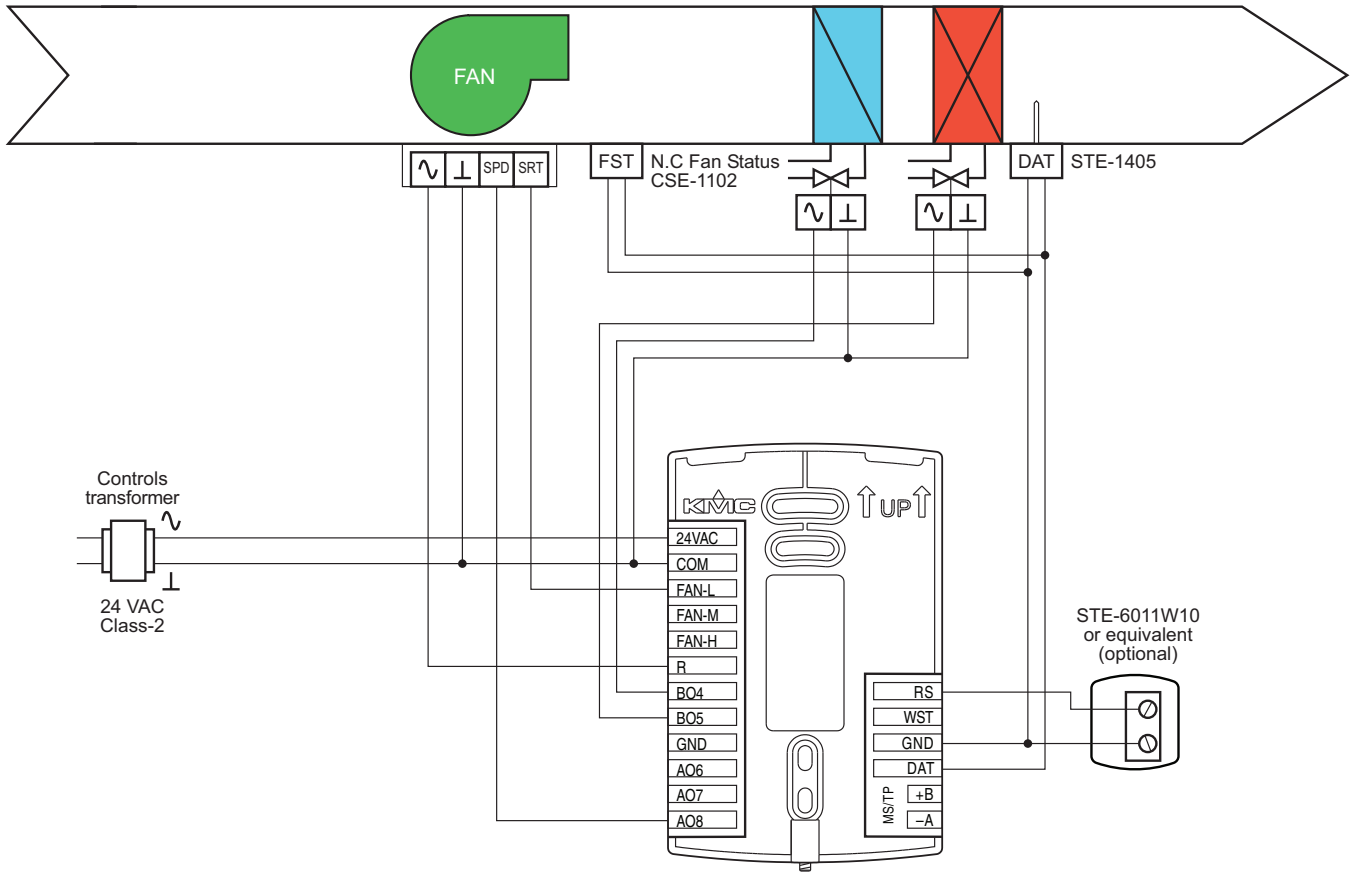

Fan Coil Unit—Four-pipe with modulating fan and modulating valves

This application applies to models BAC-4008CW0001, BAC-4028CW0001, BAC-4208CW0001, and BAC-4228CW0001.

- ◆ Fan status switch (FST) and discharge air temperature sensor (DAT) are optional. They are typically used only when the AppStat is connected to a network.
- ◆ For dehumidification, the AppStat must include a humidity sensor.
- ◆ The remote temperature sensor (RS) is optional.
- ◆ Valves are 24 Volt AC.
- ◆ Fan start output is for a 24 volt AC pilot duty input.
- ◆ Fan speed input is 0-10 volts DC.
- ◆ For additional details on connecting sensors, see [Connecting inputs on page 18](#).
- ◆ For additional detail on connecting the fan and valves, see [Connecting outputs on page 21](#).

Table 6–4 Materials list

KMC Part No.	Description	Function
CSE-1102	Differential Pressure Switch, Barb Fittings	Fan status switch
STE-6011W10	Temperature sensor, 10kΩ Type II	Remote space temperature
STE-1405	Duct temperature sensor, 10kΩ Type III	Discharge air temperature
STE-1455	Strap-on water temperature sensor, 10kΩ Type III	Water temperature sensor
XEE-6111-040	Single-hub 120 volt power transformer	Controls transformer
XEE-6112-040	Dual-hub 120 volt power transformer	
XEE-6311-075	120/240/277/480VAC, 24 VAC, 75 VA transformer	

Illustration 6-4 Wiring details: Four-pipe FCU with modulating fan and modulating valves

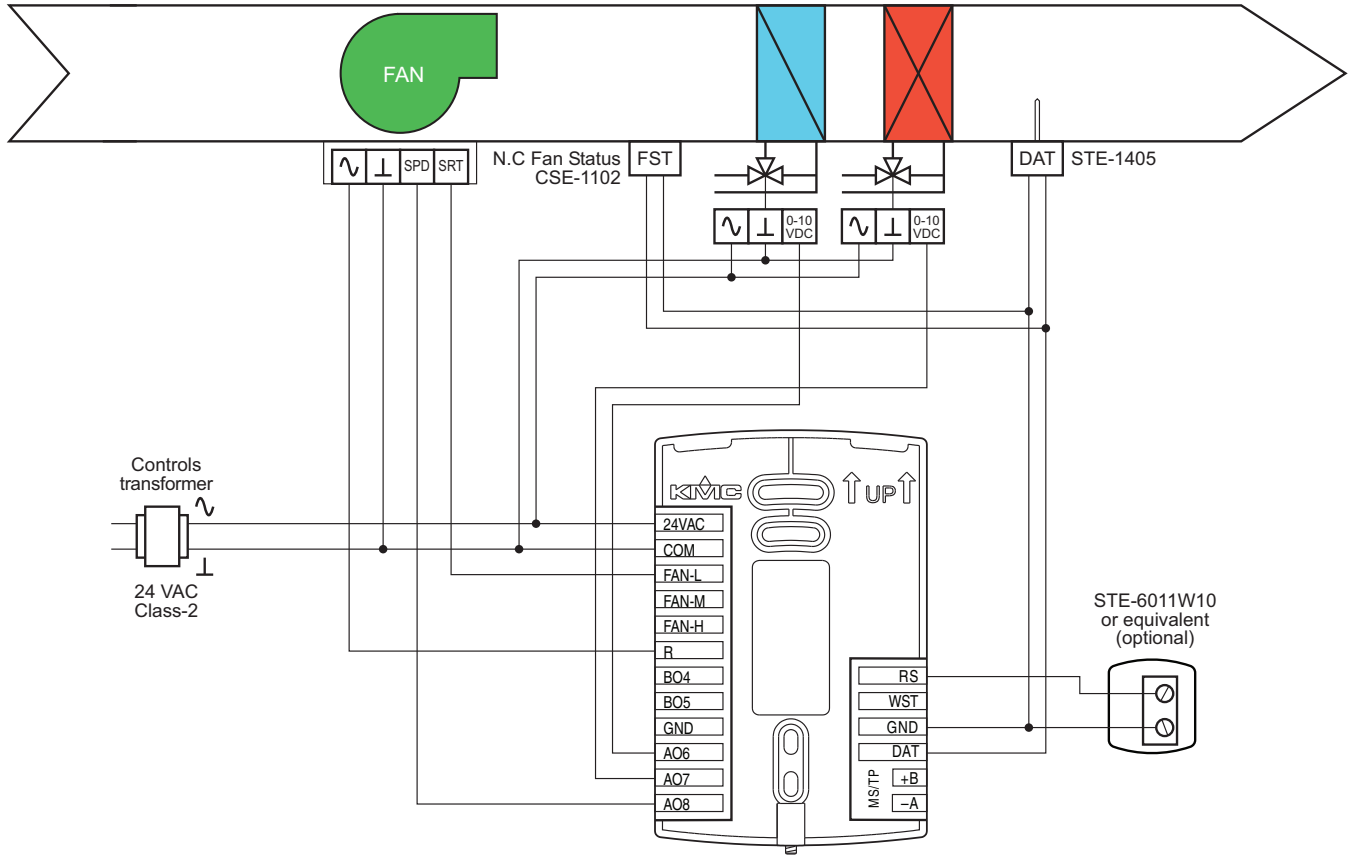

Fan Coil Unit—Two-pipe with three-speed fan and on/off valves

This application applies to models BAC-4001CW0001, BAC-4201CW0001, BAC-4021CW0001, and BAC-4221CW0001.

- ◆ The water temperature sensor (WST) is required for two-pipe units.
- ◆ Fan status switch (FST) and discharge air temperature sensor (DAT) are optional. They are typically used only when the AppStat is connected to a network.
- ◆ The remote temperature sensor (RS) is optional.
- ◆ The valve is 24 Volt AC.
- ◆ Fan outputs are for 24 volt AC pilot duty inputs.
- ◆ For additional details on connecting sensors, see [Connecting inputs on page 18](#).
- ◆ For additional detail on connecting the fan and valves, see [Connecting outputs on page 21](#).

Table 6–5 Materials list

KMC Part No.	Description	Function
CSE-1102	Differential Pressure Switch, Barb Fittings	Fan status switch
STE-1405	Duct temperature sensor, 10kΩ Type III	Discharge air temperature
STE-1455	Strap-on water temperature sensor, 10kΩ Type III	Water temperature sensor
STE-6011W10	Temperature sensor, 10kΩ Type II	Remote space temperature
XEE-6111-040	Single-hub 120 volt power transformer	Controls transformer
XEE-6112-040	Dual-hub 120 volt power transformer	
XEE-6311-075	120/240/277/480VAC, 24 VAC, 75 VA transformer	

Illustration 6-5 Wiring details: Two-pipe FCU with three-speed fan and on/off valves

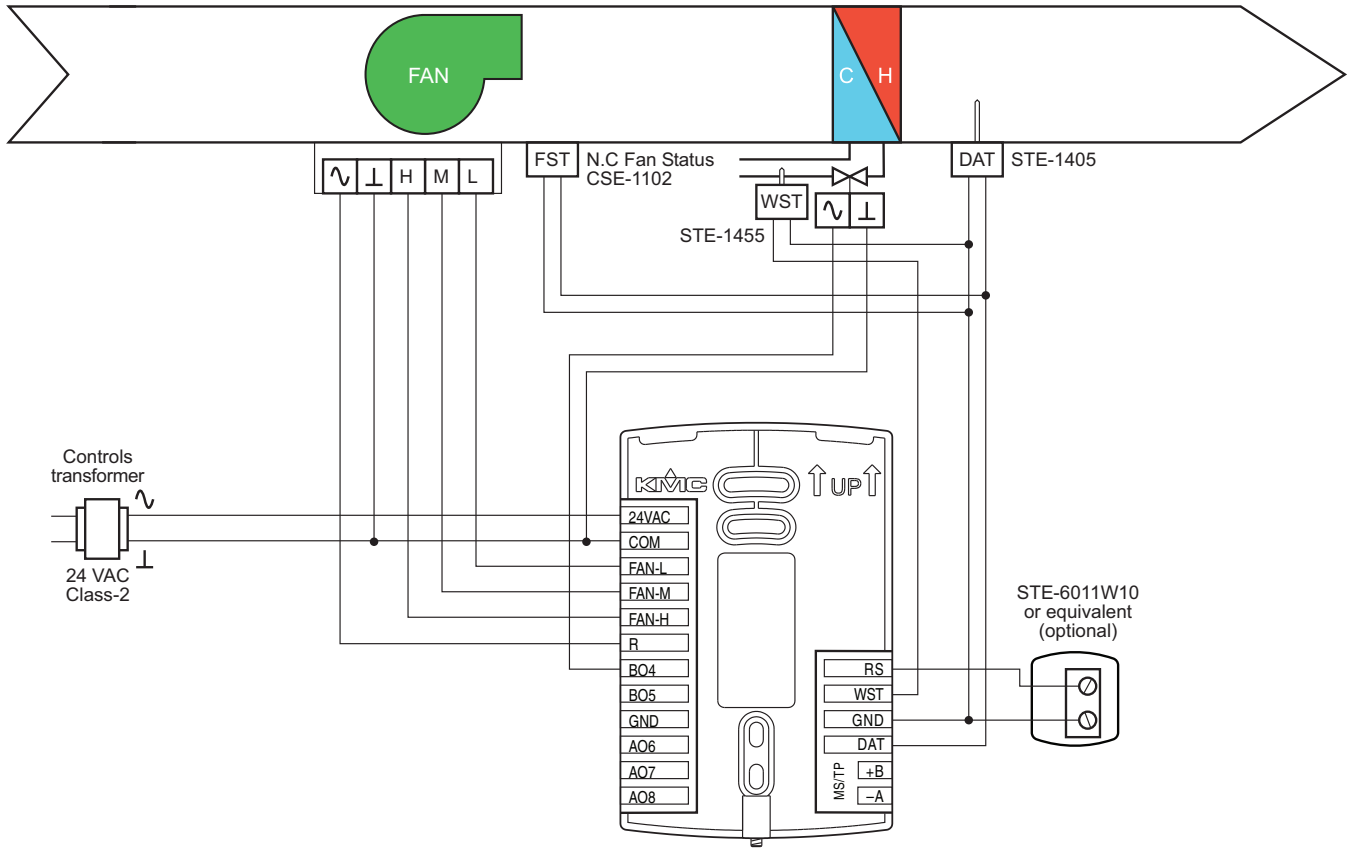

Fan Coil Unit—Two-pipe with three-speed fan and modulating valve

This application applies to models BAC-4002CW0001, BAC-4022CW0001, BAC-4202CW0001, and BAC-4222CW0001.

- ◆ The water temperature sensor (WST) is required for two-pipe units.
- ◆ Fan status switch (FST) and discharge air temperature sensor (DAT) are optional. They are typically used only when the AppStat is connected to a network.
- ◆ The remote temperature sensor (RS) is optional.
- ◆ Valves are 24 Volt AC. with a 0-10 Volt DC control signal.
- ◆ Fan outputs are for 24 volt AC pilot duty inputs.
- ◆ For additional details on connecting sensors, see [Connecting inputs on page 18](#).
- ◆ For additional detail on connecting the fan and valves, see [Connecting outputs on page 21](#).

Table 6–6 Materials list

KMC Part No.	Description	Function
CSE-1102	Differential Pressure Switch, Barb Fittings	Fan status switch
STE-1405	Duct temperature sensor, 10kΩ Type III	Discharge air temperature
STE-1455	Strap-on water temperature sensor, 10kΩ Type III	Water temperature sensor
STE-6011W10	Temperature sensor, 10kΩ Type II	Remote space temperature
XEE-6111-040	Single-hub 120 volt power transformer	Controls transformer
XEE-6112-040	Dual-hub 120 volt power transformer	
XEE-6311-075	120/240/277/480VAC, 24 VAC, 75 VA transformer	

Illustration 6-6 Wiring details: Two-pipe FCU with three-speed fan and modulating valve

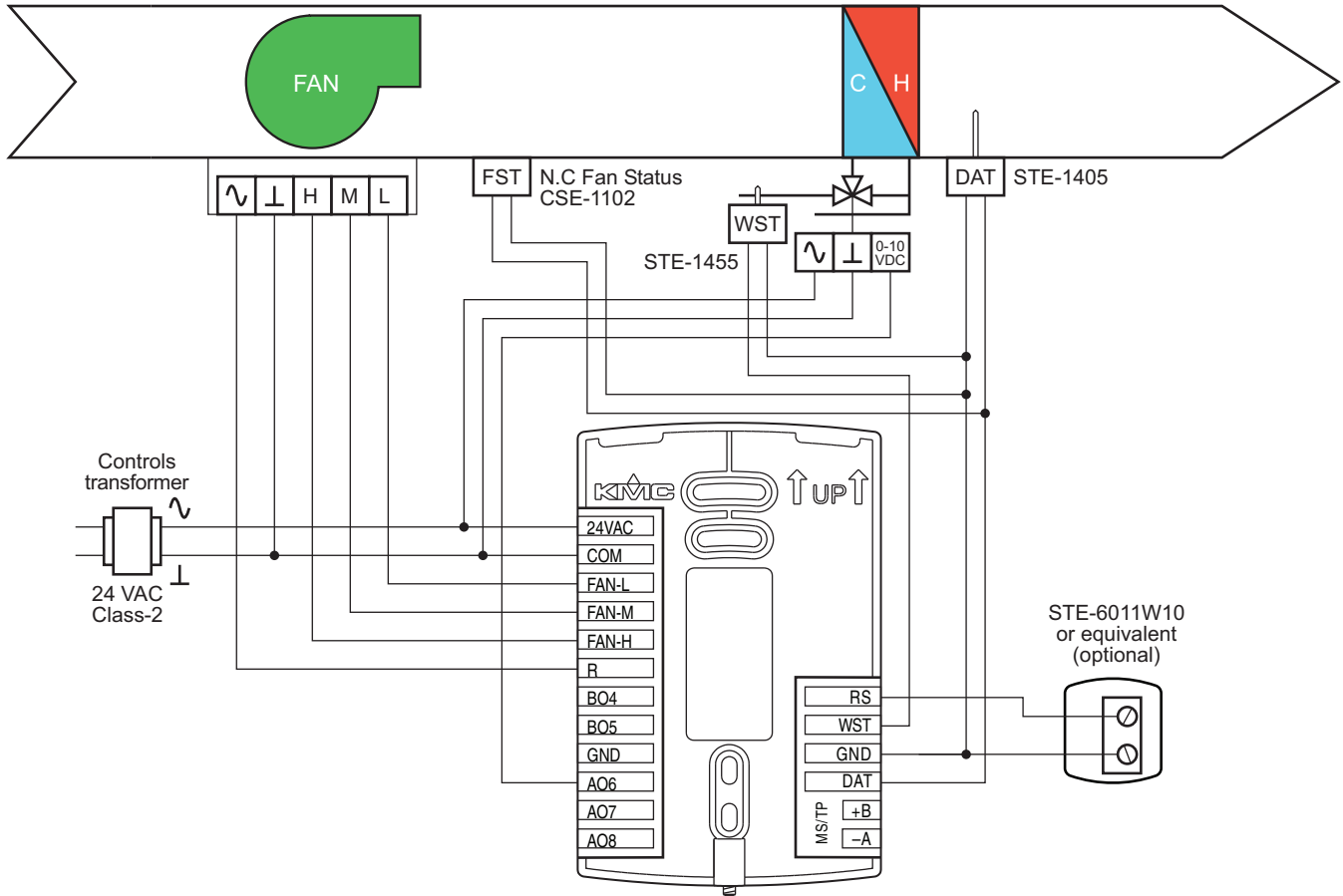

Fan Coil Unit—Two-pipe with modulating fan and on/off valve

This application applies to models BAC-4007CW0001, BAC-4027CW0001, BAC-4207CW0001, and BAC-4227CW0001.

- ◆ The water temperature sensor (WST) is required for two-pipe units.
- ◆ Fan status switch (FST) and discharge air temperature sensor (DAT) are optional. They are typically used only when the AppStat is connected to a network.
- ◆ The remote temperature sensor (RS) is optional.
- ◆ Valves are 24 Volt AC.
- ◆ Fan start output (FAN-L) is for a 24 volt AC pilot duty input.
- ◆ Fan speed output (AO8) is 0-10 volts DC.
- ◆ For additional details on connecting sensors, see [Connecting inputs on page 18](#).
- ◆ For additional detail on connecting the fan and valves, see [Connecting outputs on page 21](#).

Table 6–7 Materials list

KMC Part No.	Description	Function
CSE-1102	Differential Pressure Switch, Barb Fittings	Fan status switch
STE-1405	Duct temperature sensor, 10kΩ Type III	Discharge air temperature
STE-1455	Strap-on water temperature sensor, 10kΩ Type III	Water temperature sensor
STE-6011W10	Temperature sensor, 10kΩ Type II	Remote space temperature
XEE-6111-040	Single-hub 120 volt power transformer	Controls transformer
XEE-6112-040	Dual-hub 120 volt power transformer	
XEE-6311-075	120/240/277/480VAC, 24 VAC, 75 VA transformer	

Illustration 6-7 Wiring details: Two-pipe FCU with modulating fan and on/off valve

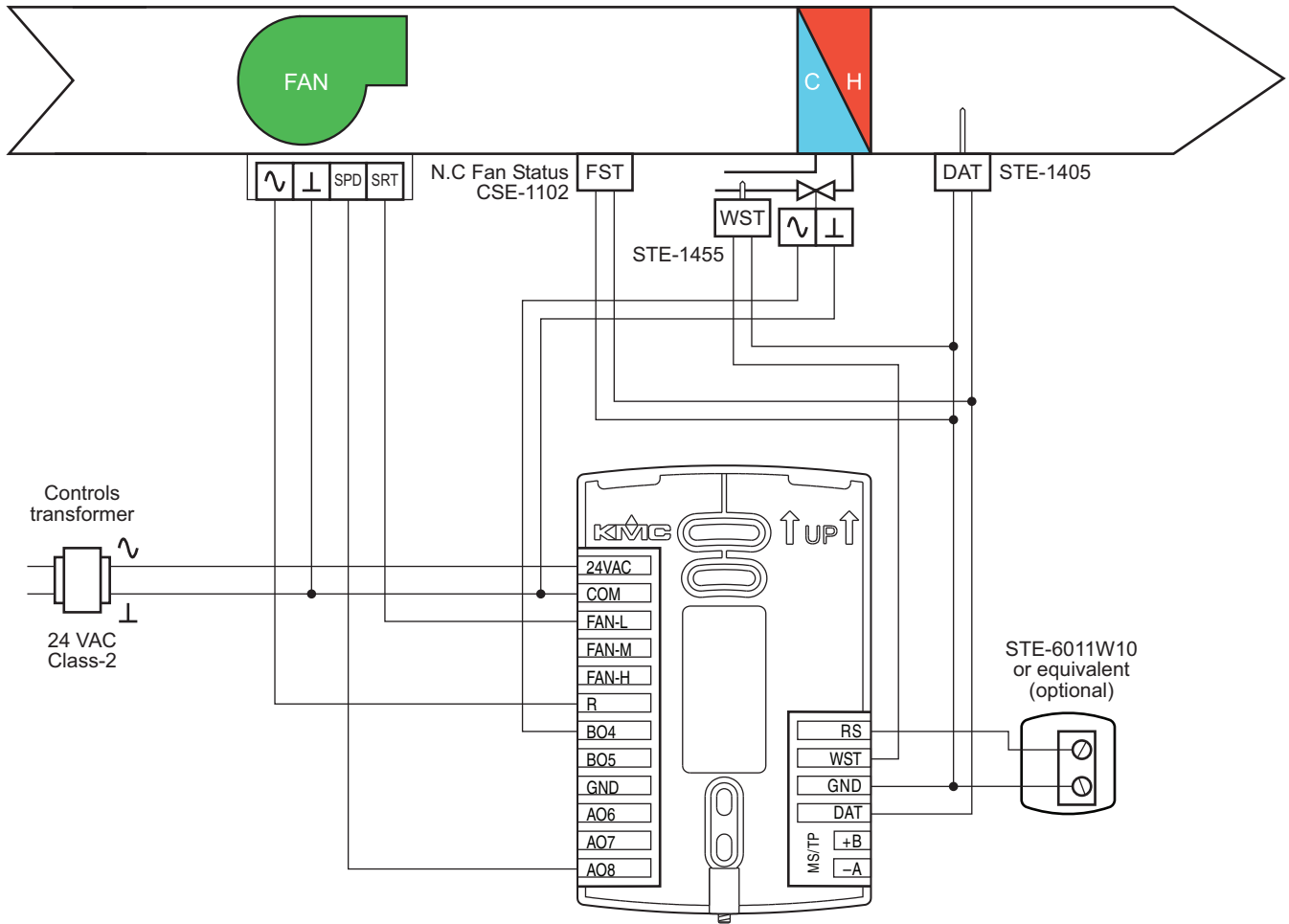

Fan Coil Unit—Two-pipe with modulating fan and modulating valve

This application applies to models BAC-4008CW0001, BAC-4028CW0001, BAC-4208CW0001, and BAC-4228CW0001.

- ◆ The water temperature sensor (WST) is required for two-pipe units.
- ◆ Fan status switch (FST) and discharge air temperature sensor (DAT) are optional. They are typically used only when the AppStat is connected to a network.
- ◆ The remote temperature sensor (RS) is optional.
- ◆ Valves are 24 Volt AC.
- ◆ Fan start output (FAN-L) is for a 24 volt AC pilot duty input.
- ◆ Fan speed output (AO8) is 0-10 volts DC.
- ◆ For additional details on connecting sensors, see [Connecting inputs on page 18](#).
- ◆ For additional detail on connecting the fan and valves, see [Connecting outputs on page 21](#).

Table 6–8 Materials list

KMC Part No.	Description	Function
CSE-1102	Differential Pressure Switch, Barb Fittings	Fan status switch
STE-1405	Duct temperature sensor, 10kΩ Type III	Discharge air temperature
STE-1455	Strap-on water temperature sensor, 10kΩ Type III	Water temperature sensor
STE-6011W10	Temperature sensor, 10kΩ Type II	Remote space temperature
XEE-6111-040	Single-hub 120 volt power transformer	Controls transformer
XEE-6112-040	Dual-hub 120 volt power transformer	
XEE-6311-075	120/240/277/480VAC, 24 VAC, 75 VA transformer	

Illustration 6-8 Wiring details: Two-pipe FCU with modulating fan and modulating valve

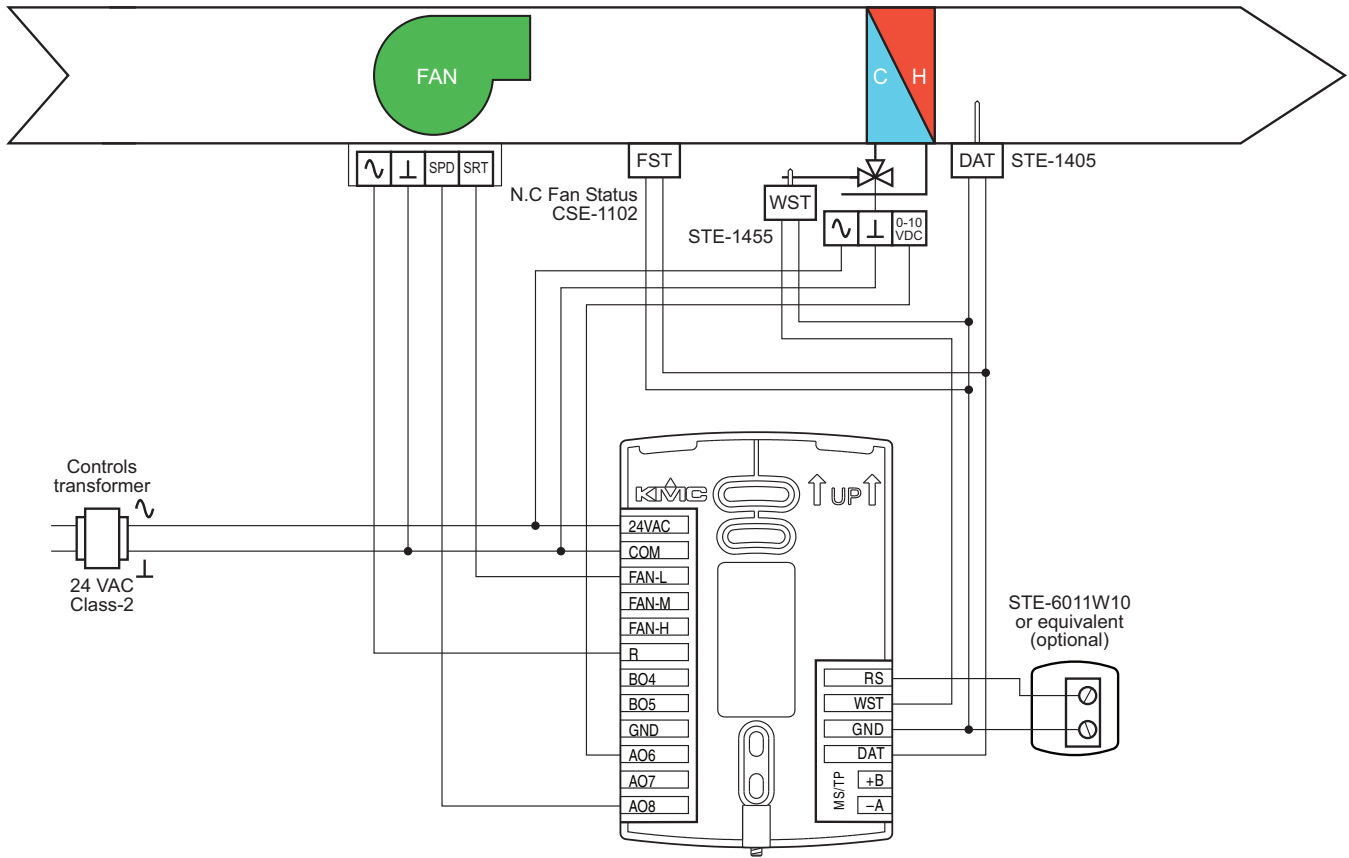

Roof Top Unit applications

This section covers applications for roof top units. For other applications see [Fan Coil Unit applications on page 68](#) and [Heat Pump Unit applications on page 92](#).

Roof Top Unit—Two-stage gas heat and two-stage DX cooling

This application applies to models BAC-4221CW0002, BAC-4021CW0002, BAC-4201CW0002, and BAC-4001CW0002.

- ◆ Fan status switch (FST) and discharge air temperature (DAT) and outdoor air temperature (OAT) sensors are optional. They are typically used only when the AppStat is connected to a network.
- ◆ For dehumidification, the AppStat must include a humidity sensor.
- ◆ The remote temperature sensor (RS) is optional.
- ◆ For single stage heating, delete connection W2.
- ◆ For single stage cooling, delete connection Y2.
- ◆ Connect outputs to 24 volt AC pilot duty inputs.
- ◆ For additional details on connecting sensors, see [Connecting inputs on page 18](#).
- ◆ For additional detail on connecting the fan and valves, see [Connecting outputs on page 21](#).

Table 6–9 Materials list

KMC Part No.	Description	Function
CSE-1102	Differential Pressure Switch, Barb Fittings	Fan status switch
STE-1405	Duct temperature sensor, 10kΩ Type III	Discharge air temperature
STE-1451	Outdoor air temperature sensor, 10kΩ Type III	Outdoor air temperature
STE-6011W10	Temperature sensor, 10kΩ Type II	Remote space temperature
XEE-6111-040	Single-hub 120 volt power transformer	Controls transformer
XEE-6112-040	Dual-hub 120 volt power transformer	
XEE-6311-075	120/240/277/480VAC, 24 VAC, 75 VA transformer	

Illustration 6-9 Wiring details: RTU two-stage gas heat and two-stage DX cooling

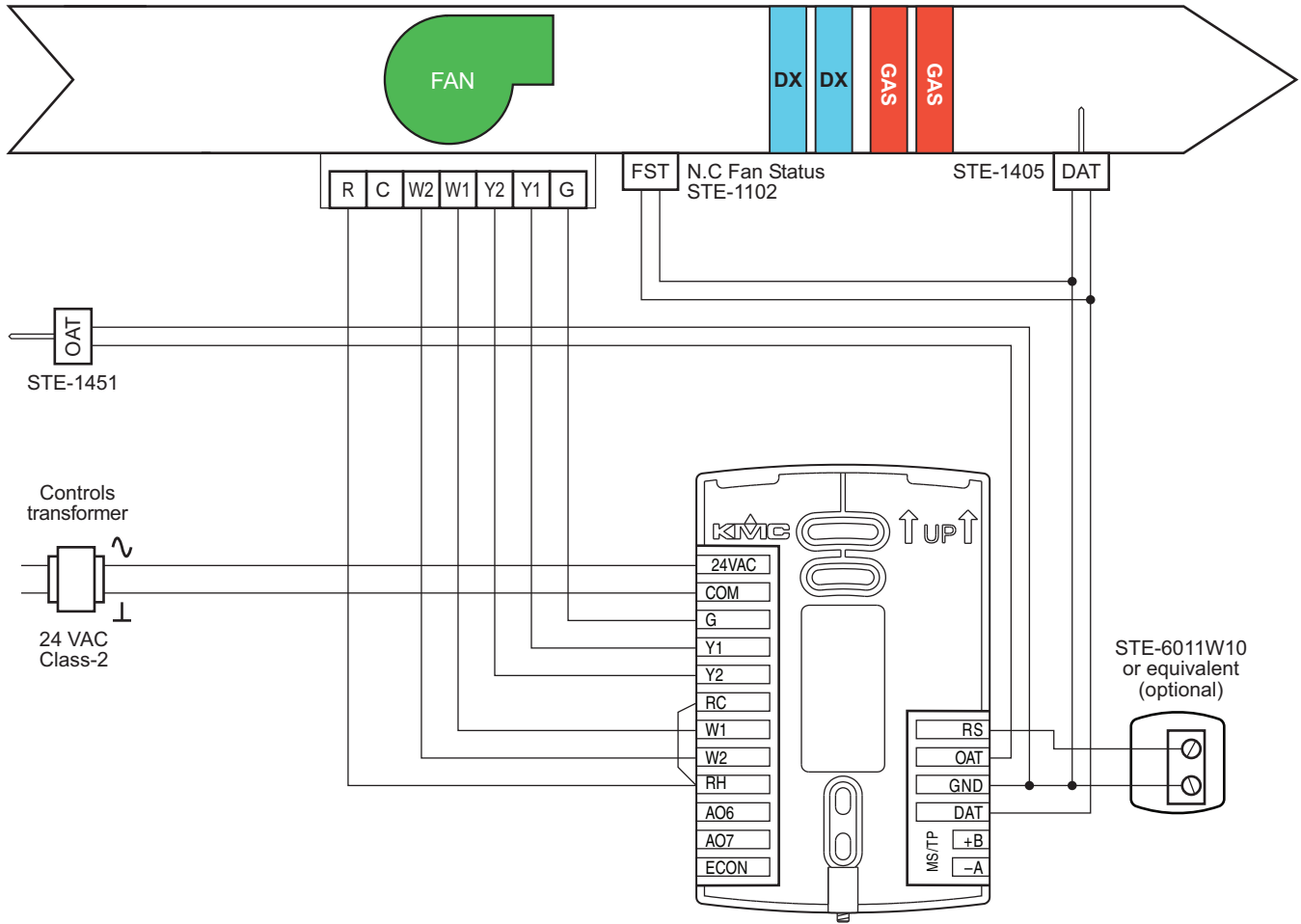

Roof Top Unit—Two-stage gas heat and two-stage DX cooling with economizer

This application applies to models BAC-4223CW0002, BAC-4023CW0002, BAC-4203CW0002, and BAC-4003CW0002

- ◆ Fan status switch (FST) is optional. Typically it is used only when the AppStat is connected to a network.
- ◆ Discharge air temperature (DAT) and outdoor air temperature (OAT) sensors are required for economizer operation.
- ◆ For dehumidification, the AppStat must include a humidity sensor.
- ◆ The remote temperature sensor (RS) is optional.
- ◆ For single stage heating, do not connect W2.
- ◆ For single stage cooling, do not connect Y2.
- ◆ Connect outputs to 24 volt AC pilot duty inputs.
- ◆ For additional details on connecting sensors, see [Connecting inputs on page 18](#).
- ◆ For additional detail on connecting the fan and valves, see [Connecting outputs on page 21](#).

Table 6–10 Materials list

KMC Part No.	Description	Function
CSE-1102	Differential Pressure Switch, Barb Fittings	Fan status switch
STE-1405	Duct temperature sensor, 10kΩ Type III	Discharge air temperature
STE-1451	Outdoor air temperature sensor, 10kΩ Type III	Outdoor air temperature
STE-6011W10	Temperature sensor, 10kΩ Type II	Remote space temperature
XEE-6111-040	Single-hub 120 volt power transformer	Controls transformer
XEE-6112-040	Dual-hub 120 volt power transformer	
XEE-6311-075	120/240/277/480VAC, 24 VAC, 75 VA transformer	

Illustration 6-10 Wiring details: RTU two-stage gas heat and two-stage DX cooling and economizer

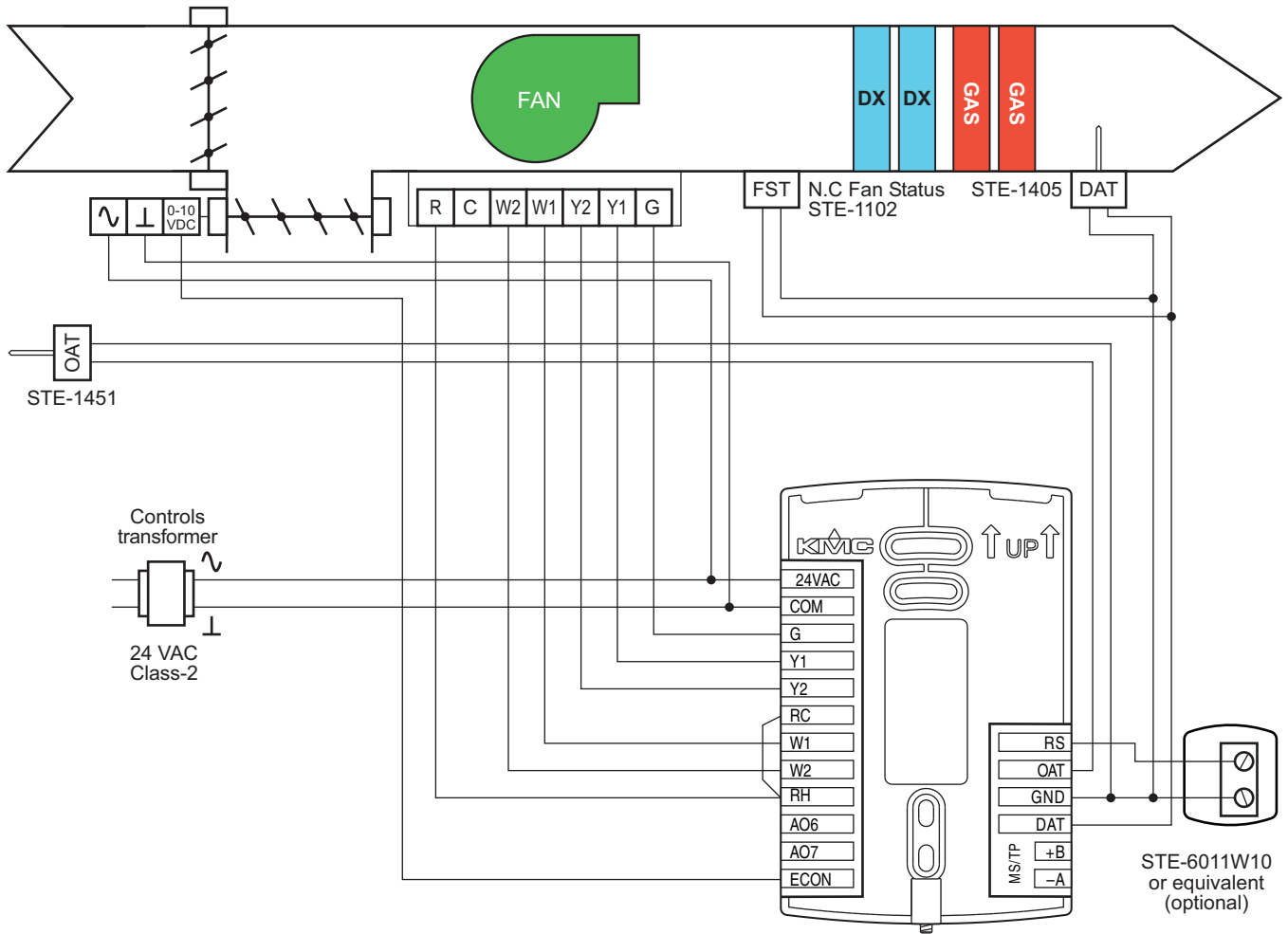

Roof Top Unit—Two-stage gas heat, chilled water cooling with economizer

This application applies to models BAC-4003CW0002, BAC-4023CW0002, BAC-4203CW0002, and BAC-4223CW0002.

- ◆ Fan status switch (FST) is optional. Typically it is used only when the AppStat is connected to a network.
- ◆ Discharge air temperature (DAT) and outdoor air temperature (OAT) sensors are required for economizer operation.
- ◆ For dehumidification, the AppStat must include a humidity sensor.
- ◆ The remote temperature sensor (RS) is optional.
- ◆ Connect heating and fan outputs to 24 volt AC pilot duty inputs.
- ◆ For additional details on connecting sensors, see [Connecting inputs on page 18](#).
- ◆ For additional details on connecting the fan and valves, see [Connecting outputs on page 21](#).

Table 6–11 Materials list

KMC Part No.	Description	Function
CSE-1102	Differential Pressure Switch, Barb Fittings	Fan status switch
STE-1405	Duct temperature sensor, 10kΩ Type III	Discharge air temperature
STE-1451	Outdoor air temperature sensor, 10kΩ Type III	Outdoor air temperature
STE-6011W10	Temperature sensor, 10kΩ Type II	Remote space temperature
XEE-6111-040	Single-hub 120 volt power transformer	Controls transformer
XEE-6112-040	Dual-hub 120 volt power transformer	
XEE-6311-075	120/240/277/480VAC, 24 VAC, 75 VA transformer	

Illustration 6-11 Wiring details: RTU with two-stage gas heat, chilled water cooling with economizer

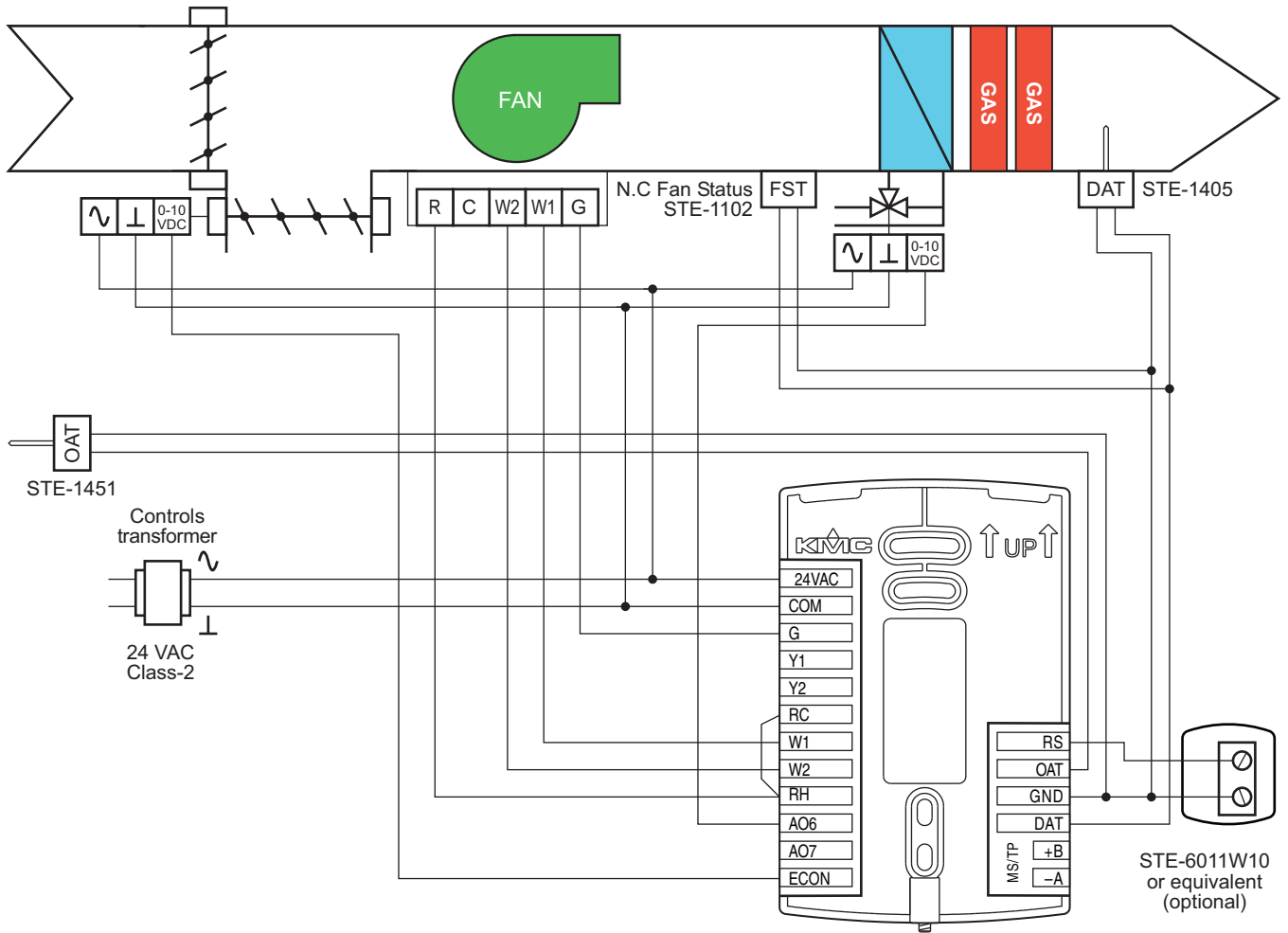

Roof top unit—Cooling and heating with modulating valves with economizer

This application applies to models BAC-4003CW0002, BAC-4023CW0002, BAC-4203CW0002, and BAC-4223CW0002.

- ◆ Fan status switch (FST) is optional. Typically it is used only when the AppStat is connected to a network.
- ◆ Discharge air temperature (DAT) and outdoor air temperature (OAT) sensors are required for economizer operation.
- ◆ For dehumidification, the AppStat must include a humidity sensor.
- ◆ The remote temperature sensor (RS) is optional.
- ◆ Connect the fan output to a 24 volt AC pilot duty input.
- ◆ For additional details on connecting sensors, see [Connecting inputs on page 18](#).
- ◆ For additional details on connecting the fan and valves, see [Connecting outputs on page 21](#).

Table 6–12 Materials list

KMC Part No.	Description	Function
CSE-1102	Differential Pressure Switch, Barb Fittings	Fan status switch
STE-1405	Duct temperature sensor, 10kΩ Type III	Discharge air temperature
STE-1451	Outdoor air temperature sensor, 10kΩ Type III	Outdoor air temperature
STE-6011W10	Temperature sensor, 10kΩ Type II	Remote space temperature
XEE-6111-040	Single-hub 120 volt power transformer	Controls transformer
XEE-6112-040	Dual-hub 120 volt power transformer	
XEE-6311-075	120/240/277/480VAC, 24 VAC, 75 VA transformer	

Illustration 6-12 Wiring details: RTU with modulating valves cooling and heating valves and economizer

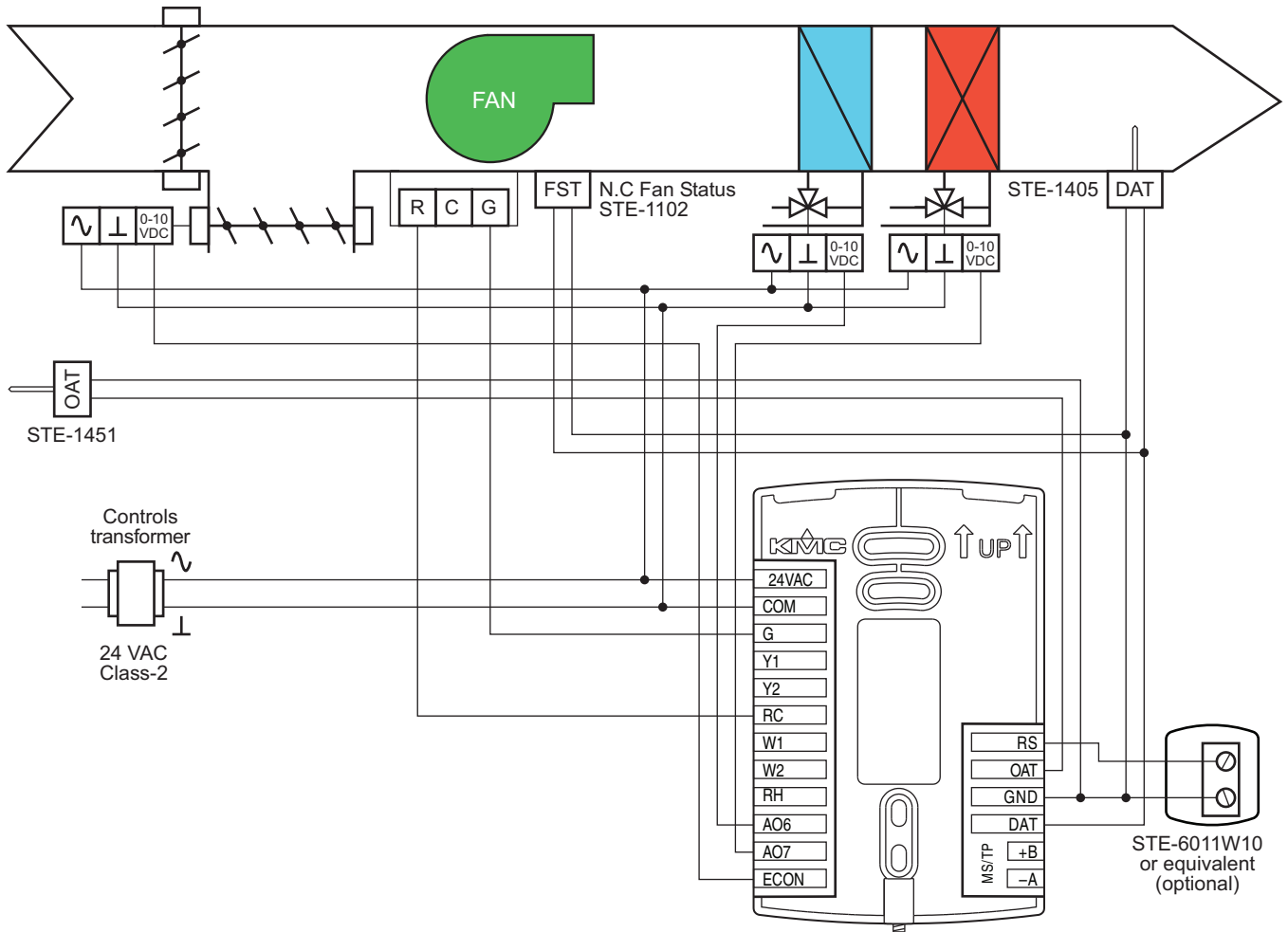

Heat Pump Unit applications

This section covers applications for fan coil units. For other applications see [Fan Coil Unit applications on page 68](#) and [Roof Top Unit applications on page 84](#).

Heat pump unit—Three heat, two cool

This application applies to models BAC-4001CW0003, BAC-4021CW0003, BAC-4201CW0003, and BAC-4221CW0003.

- ◆ Fan status switch (FST) and discharge air temperature sensor (DAT) are optional. They are typically used only when the AppStat is connected to a network.
- ◆ The outdoor air temperature sensor (OAT) is required for compressor lockout based on outside air temperature.
- ◆ For dehumidification, the AppStat must include a humidity sensor.
- ◆ Axillary heat is required for dehumidification.
- ◆ The remote temperature sensor (RS) is optional.
- ◆ For single compressor installations, delete the Y2 connection.
- ◆ If axillary heat is not required delete the AUX/E connection.
- ◆ Connect outputs only to 24 volt AC pilot duty inputs.
- ◆ For additional details on connecting sensors, see [Connecting inputs on page 18](#).

Table 6–13 Materials list

KMC Part No.	Description	Function
CSE-1102	Differential Pressure Switch, Barb Fittings	Fan status switch
STE-1405	Duct temperature sensor, 10kΩ Type III	Discharge air temperature
STE-1451	Outdoor air temperature sensor, 10kΩ Type III	Outdoor air temperature
STE-6011W10	Temperature sensor, 10kΩ Type II	Remote space temperature
XEE-6111-040	Single-hub 120 volt power transformer	Controls transformer
XEE-6112-040	Dual-hub 120 volt power transformer	
XEE-6311-075	120/240/277/480VAC, 24 VAC, 75 VA transformer	

Illustration 6-13 Wiring details: HPU—Three heat, two cool

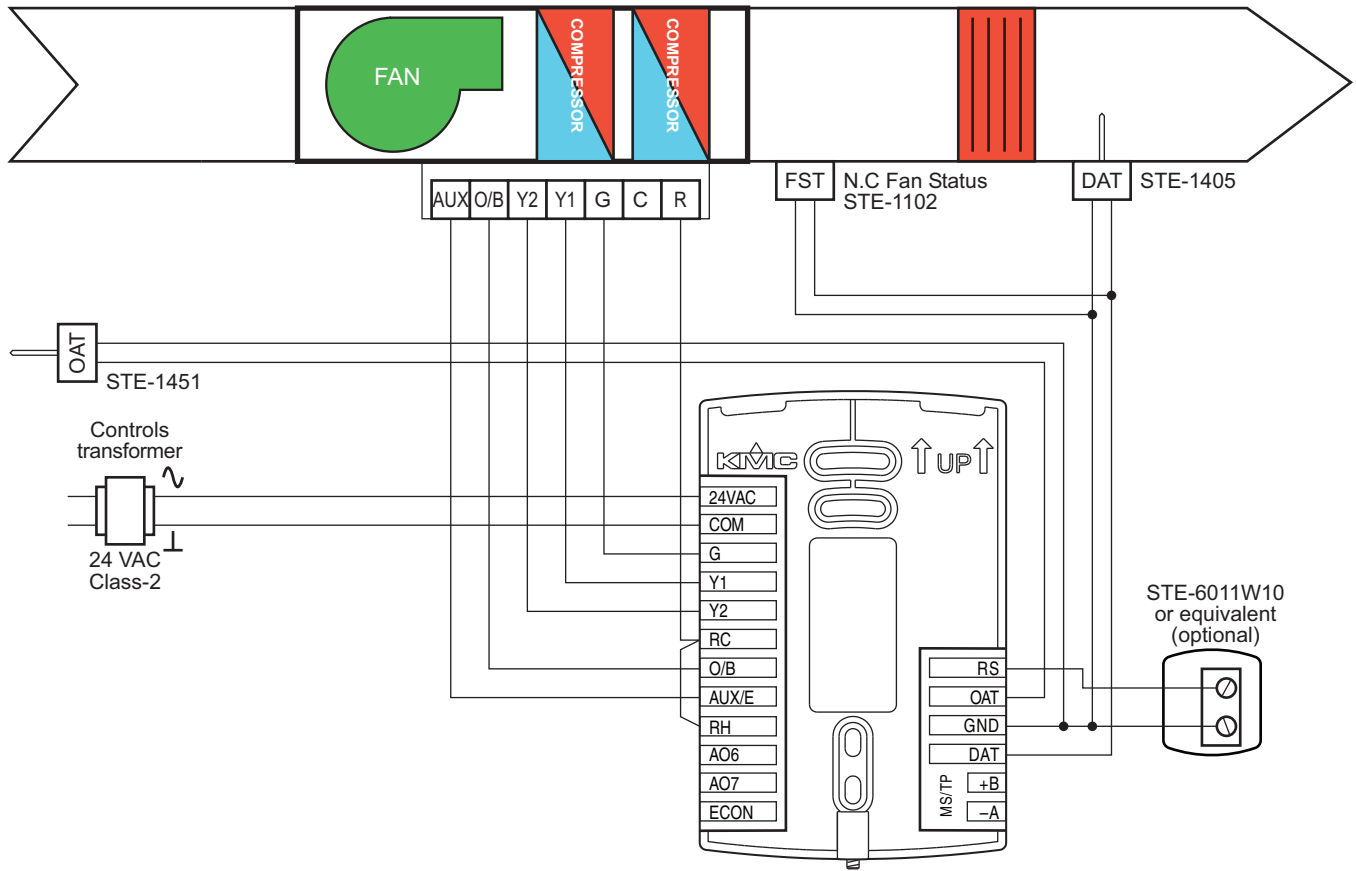

Heat Pump Unit—Three heat, two cool and economizer

This application applies to models BAC-4003CW0003, BAC-4023CW0003, BAC-4203CW0003, and BAC-4223CW0003.

Heat pump unit installation notes

- ◆ Fan status switch (FST) and discharge air temperature sensor (DAT) are optional. They are typically used only when the AppStat is connected to a network.
- ◆ The outdoor air temperature sensor (OAT) is required for compressor lockout based on outside air temperature.
- ◆ For dehumidification, the AppStat must include a humidity sensor.
- ◆ Axillary heat is required for dehumidification.
- ◆ The remote temperature sensor (RS) is optional.
- ◆ For single compressor installations, delete the Y2 connection.
- ◆ If axillary heat is not required delete the AUX/E connection.
- ◆ Connect outputs only to 24 volt AC pilot duty inputs.
- ◆ Economizer (ECON) input is 0-10 volts DC.
- ◆ For additional details on connecting sensors, see [Connecting inputs on page 18](#).

Table 6–14 Materials list

KMC Part No.	Description	Function
CSE-1102	Differential Pressure Switch, Barb Fittings	Fan status switch
STE-1405	Duct temperature sensor, 10kΩ Type III	Discharge air temperature
STE-1451	Outdoor air temperature sensor, 10kΩ Type III	Outdoor air temperature
STE-6011W10	Temperature sensor, 10kΩ Type II	Remote space temperature
XEE-6111-040	Single-hub 120 volt power transformer	Controls transformer
XEE-6112-040	Dual-hub 120 volt power transformer	
XEE-6311-075	120/240/277/480VAC, 24 VAC, 75 VA transformer	

Illustration 6-14 Wiring details: HPU with three heat, two cool and economizer

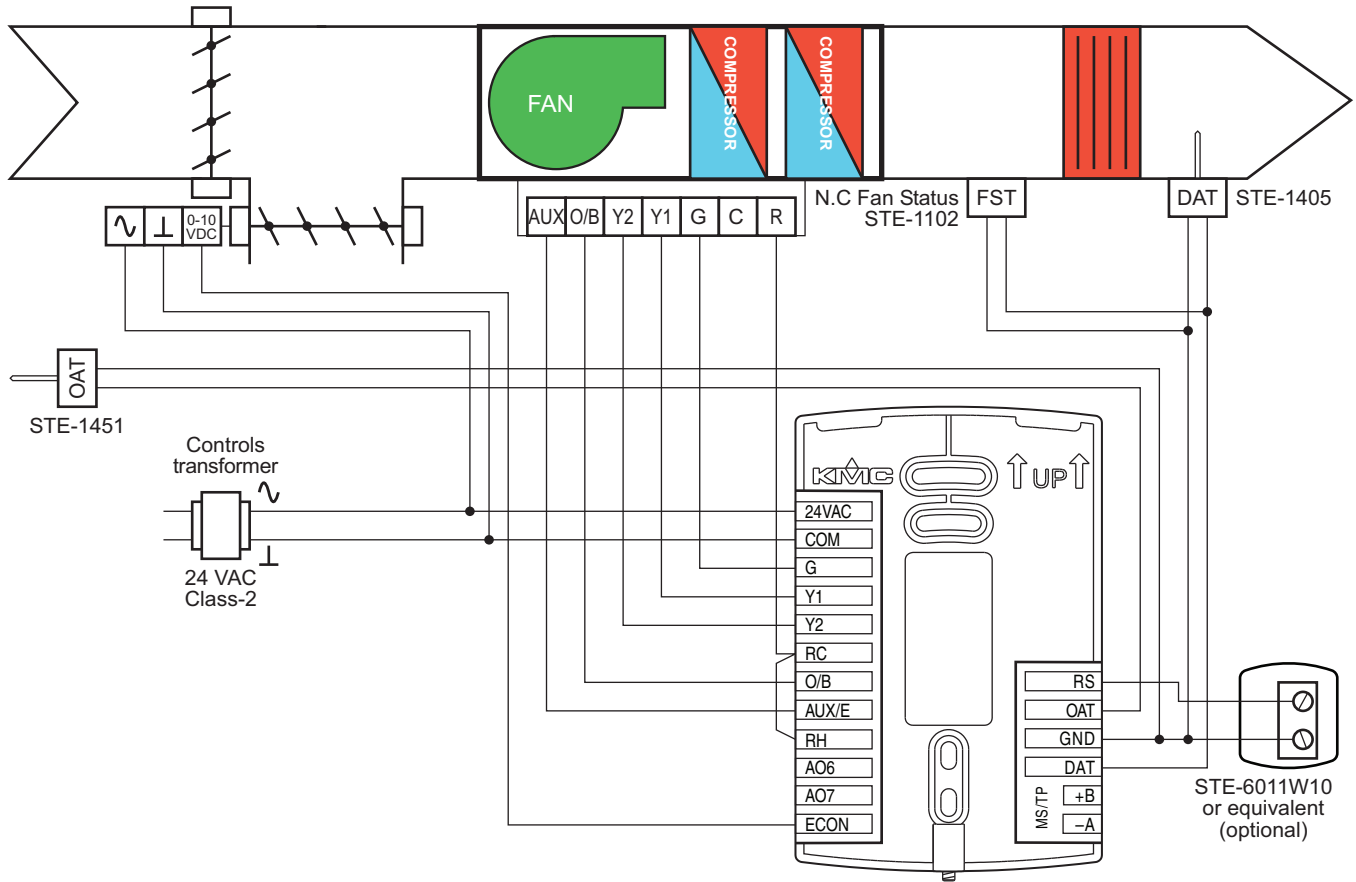

Section 7: **System integration**

Topics in this section cover integrating AppStat controllers into a building automation network. These are advanced topics for control technicians and engineers.

The AppStat can function as a standalone controller or it can be connected to a BACnet MS/TP network. The topics in this section are reference material for control technicians or engineers that will be installing and setting up an AppStat that is connected to a network.

In addition to the information in this section, you will also need the following information.

- ◆ Detailed plans and drawings for the building automation system.
- ◆ Information about the facility LAN including routers, switches, and network firewalls.
- ◆ Application Note *AN0404A Planning BACnet Networks* This document is available from the KMC Controls partners web portal.

Topics in this section

- ◆ [BACnet objects on page 98](#)
- ◆ [Connecting to a network on page 104](#)

BACnet objects

The AppStat is a BACnet Application Specific Controller (ASC) that is composed of standard BACnet objects. This section lists the objects that are likely to be needed for viewing with a standard BACnet operator workstation to verify system operation.



Changing the configuration of any object may result in unpredictable operation of the AppStat and damage to equipment that is under control of the AppStat.

Input objects

The following BACnet input objects represent values at the physical inputs of the AppStat. Only inputs 1-3 are available for external connections. For input wiring details see [Connecting inputs on page 18](#). For application specific wiring details see the section [Application drawings on page 67](#).

Note: Not all input objects are present in every model.

Table 7-1 AppStat Input objects

Input	NAME	DESCRIPTION	DEVICE TYPE	Models
AI1	REMOTE_SENSOR	Remote Room Sensor	KMC10K_Type_II	All
AI2	WATER_TEMP	Water Temperature	KMC10K_Type_III	FCU only
AI2	OAT	Outdoor Air Temp	KMC10K_Type_III	HPU, RTU
AI3	DAT	Discharge Air Temperature	KMC10K_Type_III	All
AI4	LOCAL_SENSOR	Space Temperature	KMC10K_Type_II	All
AI5	HUMIDITY	Space Humidity	NONE	All
BI6	MOTION_SENSOR	Motion Sensor	Unknown	All

Output objects

The following BACnet output objects represent values at the physical outputs of the AppStat. For output wiring details see [Connecting outputs on page 21](#). For application specific wiring details see the section [Application drawings on page 67](#).

Note: Not all objects are present in every model.

Table 7–2 Fan coil unit, two-pipe

Output	Name	Description	Device type
AO6	VALVE	Analog Valve Output	0-100% (0-10 V)
AO8	AUX HEAT	Auxiliary Heat	0-100% (0-10V)
AO8	FAN_SPEED_AO	Fan Speed Control	0-100% (0-10V)
BO1	LOW	Fan Low Speed	Unknown
BO1	FAN_START_STOP	Fan Start/Stop	Unknown
BO2	MEDIUM	Fan Medium Speed	Unknown
BO3	HIGH	Fan High Speed	Unknown
BO4	VALVE	Valve	Unknown
BO5	AUX HEAT	Auxiliary Heat	Unknown

Table 7–3 Fan coil units, four-pipe

Output	Name	Description	Device type
AO6	COOLING_VLV	Analog Cooling Output	0-100% (0-10 V)
AO7	HEATING_VLV	Analog Heating Output	0-100% (0-10 V)
AO8	FAN_SPEED_AO	Fan Speed Control	0-100% (0-10V)
BO1	LOW	Fan Low Speed	Unknown
BO1	FAN_START_STOP	Fan Start/Stop	Unknown
BO2	MEDIUM	Fan Medium Speed	Unknown
BO3	HIGH	Fan High Speed	Unknown
BO4	COOLING_VLV	Cooling Valve	Unknown
BO5	HEATING_VLV	Heating Valve	Unknown

Table 7-4 Roof top units

Output	Name	Description	Device type
AO6	COOLING_OUTPUT	Analog Cooling Output	0-100% (0-10 V)
AO7	HEATING_OUTPUT	Analog Heating Output	0-100% (0-10 V)
AO8	ECON_DAMPER	Economizer Output	0-100% (0-10 V)
BO1	FAN	Fan Start - Stop	Unknown
BO2	COOL_STAGE_1	Cool Stage 1	Unknown
BO3	COOL_STAGE_2	Cool Stage 2	Unknown
BO4	HEAT_STAGE_1	Heat Stage 1	Unknown
BO5	HEAT_STAGE_2	Heat Stage 2	Unknown

Table 7-5 Heat pump units

Output	Name	Description	Device type
AO8	ECON_DAMPER	Economizer Output	0-100% (0-10 V)
BO1	FAN	Fan Start - Stop	Unknown
BO2	COMPRESSOR_1	Stage 1 Compressor	Unknown
BO3	COMPRESSOR_2	Stage 2 Compressor	Unknown
BO4	REVERSING_VALVE	Reversing Valve	Unknown
BO5	AUXILIARY_HEAT	Auxiliary Heat	Unknown

Value objects

BACnet value objects represent setpoints or other operational data in the AppStat.

Setpoints—The analog value objects in the following table represent operational setpoints for the AppStat applications. All of the setpoints are available from the user interface.

Note: Not all objects are present in every model.

Table 7–6 Analog value objects—Setpoints

Value object	Name	Description
AV3	ACT_COOL_STPT	Active Cooling Setpoint
AV4	ACT_HEAT_STPT	Active Heating Setpoint
AV5	OCC_CL_STPT	Occupied Cooling Setpoint
AV6	OCC_HT_SPT	Occupied Heating Setpoint
AV7	UNOCC_CL_STPT	Unoccupied Cooling Setpoint
AV8	UNOCC_HT_STPT	Unoccupied Heating Setpoint
AV9	MIN_CL_STPT	Minimum Cooling Setpoint
AV10	MAX_HT_STPT	Maximum Heating Setpoint
AV11	MIN_STPT_DIFF	Minimum Setpoint Differential
AV12	STBY_OFFSET	Standby Offset
AV22	DEHUM_STPT	Dehumidification Setpoint
AV24	DEHUM_DEADBAND	Dehumidification Deadband

Temperature points—The following analog value objects represent temperatures points derived from the AppStat input sensors.

Table 7–7 Analog value objects—Temperature points

Value object	Name	Description
AV1	SPACE_TEMP	Space Temperature
AV19	OUTDOOR_TEMP	Outdoor Air Temperature
AV20	DISCHARGE_TEMP	Discharge Air Temp
AV21	REL_HUMIDITY	Relative Humidity

Economizer and heat pump unit setpoints—The following analog value objects represent setpoints for AppStat heat pump unit and economizer operation.

Table 7–8 Analog value objects—Economizer and HPU setpoints

Value object	Name	Description
AV13	DAT_RESET	Discharge Air Reset STPT
AV14	MIN DAT	Min Discharge Air Temp
AV15	MIN_ECON_DAMPER	Minimum Econ Damper
AV16	ECON_ENABLE_TEMP	Economizer Enable Temperature
AV17	CMP_LOCKOUT	Compressor Lockout Temperature
AV18	AUX_HT_LOCKOUT	OAT AUX Heat Lockout

Operating states and modes—The binary and multistate value objects represent operating conditions in the AppStat. Objects BV5 and BV36 are related to the schedule.

Table 7–9 Binary value objects

Value object	Name	Description
BV5	OCC_SCHEDULE	Occupy Schedule
BV14	FAN_STATUS	Fan Proof
BV28	LOCAL_OVRD	Local Override Mode
BV36	STPT_HOLD	Hold Temperature Setpoint

Table 7–10 Multistate value objects

Value object	Name	Description
MSV1	OCCUPIED_MODE	Occupied Mode
MSV2	SYSTEM_MODE	Control Mode
MSV3	FAN_MODE	Fan Auto-Manual Mode

Schedule object

The AppStat occupancy state is controlled from a standard BACnet schedule object. The occupancy state is stored in the reference object. The exception schedule within the schedule object is represented in the user interface as the holiday schedules.

Table 7–11 Schedule object

Object	Name	Description	Object reference
1	SCHED_1	Schedule #1	BV5

Loop objects

The BACnet PID loops are used for valve and fan modulation, staging, economizer operation, and reheat during dehumidification. The proportional and integral properties of the cooling and heating loops are available from the user interface.

Note:

Not all objects are present in every model.

Table 7–12 PID control loops

Loop	Name	Description
LOOP1	CL LOOP	Cooling Loop
LOOP2	HT LOOP	Heating Loop
LOOP3	DAT LOOP	Discharge Air Temp Loop
LOOP4	REHEAT	Reheat for Dehumidification

Connecting to a network

Before connecting the AppStat to a BACnet MS/TP network, configure the network properties. See the topic [Set up communications on page 37](#) for the procedure to set the following:

- ◆ Device instance
- ◆ MAC address
- ◆ Baud

Use the following principles when wiring the AppStat to an MS/TP network:

- ◆ Connect no more than 128 addressable BACnet devices to one MS/TP network. The devices can be any mix of AppStat controllers, other BACnet controllers, or BACnet routers.
- ◆ To prevent network traffic bottlenecks, limit the MS/TP network size to 60 controllers.
- ◆ Use 18 gauge, twisted pair, shielded cable with capacitance of no more than 51 picofarads per foot for all network wiring. Belden cable model #82760 meets the cable requirements.
- ◆ Connect the -A terminal in parallel with all other - terminals.
- ◆ Connect the +B terminal in parallel with all other + terminals.
- ◆ Connect the shield to an earth ground at one end only.
- ◆ Use a KMD-5575 repeater between every 32 MS/TP devices or if the cable length will exceed 4000 feet (1220 meters). Use no more than seven repeaters per MS/TP network.
- ◆ Place a KMD-5567 surge suppressor in the cable where it exits a building.

For more information on installing HVAC system controllers, see *Application Note AN0404A, Planning BACnet Networks*.

Illustration 7-1 BACnet MS/TP network wiring

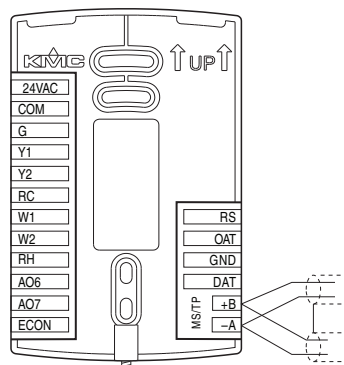

The controllers or devices on the physical ends of the MS/TP wiring segment must have end-of-line (EOL) termination installed for proper network operation. See [Location for end-of-line termination on page 105](#). Set the end-of-line termination to On using the EOL switches.

Illustration 7-2 Location for end-of-line termination

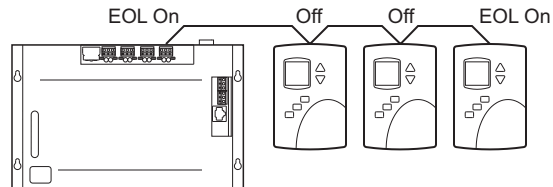

[Location of EOL switch on page 105](#) shows the position of the EOL switches in the AppStat controller.

Illustration 7-3 Location of EOL switch

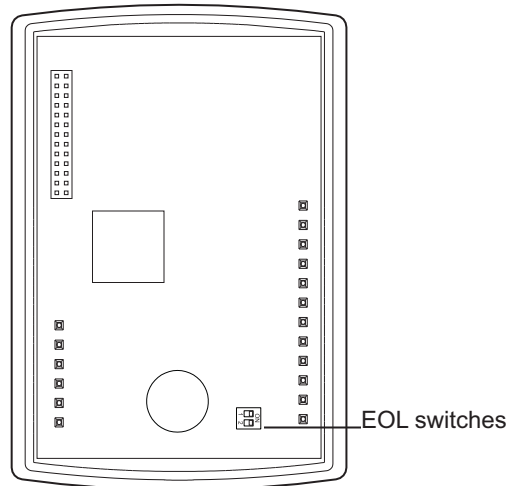

Index

A

- accuracy
 - humidity 7
 - temperature 7
- analog value objects 101
- application drawings
 - fan coil unit 68
 - heat pump unit 92
 - roof top unit 84

B

- BACnet
 - baud 37
 - device instance 37
 - input objects 98
 - loop objects 103
 - MAC address 37
 - output objects 99
 - PID loops 60
 - schedule object 103
 - time 38
 - value objects 101
- baud 37
- binary value objects 101

C

- Celsius 30
- clock 38
- communications 37

D

- date, setting 38
- dehumidification sequence 60
- device instance 37
- dimensions 9
- display size 6

E

- economizer
 - operation 64
 - setpoint objects 101
- environmental limits 8

EOL switches 104

F

- Fahrenheit 30
- fan coil unit
 - application drawings 68
 - fan sequence 62
 - valve sequence 61

H

- heat pump unit
 - application drawings 92
 - fan sequence 64
 - sequence of operation 65

I

- icons 25
- inputs
 - BACnet objects 98
 - wiring 18

L

- loops
 - BACnet object 103
 - sequence of operation 60

M

- MAC address 37
- maintenance 24
- metric display 30
- motion sensing
 - planning 15
 - range 9
- multistate value objects 101

N

- network
 - baud 37
 - communications 37
 - specifications 7
 - termination 104
 - wiring 104

O

- occupancy schedule 40
- occupied setpoints 35

outputs

- BACnet objects 99
- wiring 21

P

- Password 2 34
- passwords
 - Password 1 29
 - Password 2 34
 - user 28-29
- power 23

R

- regulatory approvals 8
- roof top unit
 - application drawings 84
 - fan sequence 64
 - modulating cooling and heating 63
 - staged cooling and heating 63

S

- schedules
 - BACnet 40
 - BACnet object 103
 - sequence of operation 60
 - setting 40
- sequence of operation 57
 - automatic changeover 59
 - dehumidification 60
 - economizer 64
 - fan coil valves 61
 - heat pump fans 64
 - heat pump staged cooling and heating 63
 - heat pump unit 65
 - motion sensing 59
 - occupancy 59
 - PID loops 60
 - roof top fans 64
 - roof top modulating valves 63
 - roof top staged cooling and heating 63
 - schedules 60
 - setpoints 58
 - standby 59
- setpoints
 - cooling 29
 - differential 35

- heating 29
 - minimum and maximum 35
 - occupied 35
 - sequence 58
 - temperature 58
 - unoccupied 35
- softkey bar 25
- specifications 6
 - dimensions 9
 - environmental limits 8
 - humidity accuracy 7
 - inputs 6
 - motion sensing 9
 - MS/TP network 7
 - outputs 6
 - temperature accuracy 7
 - temperature accuracy 7
 - user interface 6
- staged cooling and heating
 - fan coil sequence 61
 - heat pump sequence 63
 - roof top unit sequence 63

T

- temperature
 - BACnet objects 98
- termination, MS/TP 104
- time, setting 38

U

- unoccupied setpoints 35
- user interface 6
- user password 28

W

- wiring
 - fan coil units 68
 - heat pump unit 92
 - inputs 18
 - MS/TP network 104
 - outputs 21
 - power 23
 - roof top unit 84
 - rough-in 16