

Robertshaw
SlimZone Deluxe
ZONE CONTROL SYSTEM

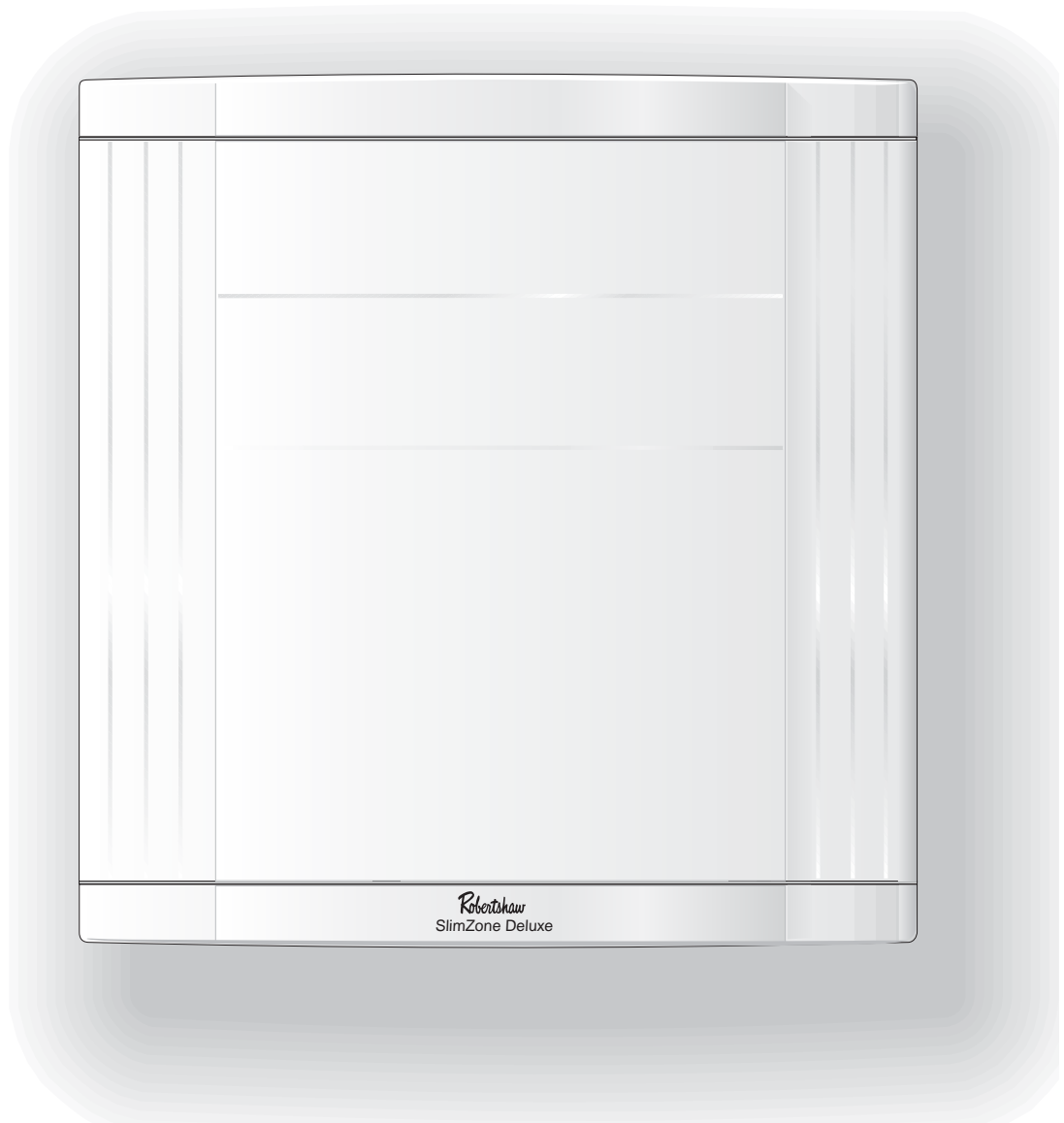

***INSTALLATION AND OPERATION
MANUAL***

TABLE OF CONTENTS

1.	INTRODUCTION	1
2.	OPERATIONAL FEATURES	1
3.	SAFETY INSTRUCTIONS	2
4.	APPLICATION AND DESIGN CONSIDERATIONS	2
5.	COMPONENT REQUIREMENTS	3
5.1	BASIC SYSTEM	3
5.2	EXPANDED SYSTEM	4
5.3	OPTIONAL ITEMS FOR BASIC AND EXPANDED SYSTEM	4
6.	SYSTEM INSTALLATION	5
6.1	UNPACKING THE 2701-002 LOGIC PANEL	5
6.2	INSTALLING THE 2701-003 EXPANDER BOARD	5
6.3	INSTALLING THE BACKPLATE	5
6.4	ZONE THERMOSTAT INSTALLATION	5
6.5	SYSTEM WIRING	5
6.6	LOGIC PANEL POWER SUPPLY	6
6.7	MOTORIZED ZONE DAMPER POWER SUPPLY	6
6.8	MOTORIZED ZONE DAMPER INSTALLATION	6
6.9	BYPASS DAMPER INSTALLATION	6
6.10	CURRENT LIMITED OUTPUT TERMINALS	7
6.11	LED	7
7.	ROBERTSHAW SLIMZONE DELUXE SEQUENCE OF OPERATION	7
7.1	INITIAL POWER UP	7
7.2	REVERSING VALVE OPERATION	8
7.3	FAN OPERATION	8
7.4	GENERAL CONTROL ALGORITHM	8
7.5	MINIMUM ON/OFF TIME DELAYS	8
7.6	FAN PURGE	8
7.7	TIME UPSTAGING	8
7.8	ZONE UPSTAGING	9
7.9	HIGH AND LOW LIMIT TERMINALS	9
7.10	HIGH BALANCE POINT (HI BP) (ODT) TERMINALS	9
7.11	LOW BALANCE POINT (LO BP) TERMINALS	9
7.12	CLOCK TERMINALS	9
7.13	SMOKE DETECTOR TERMINALS	9
7.14	AUXILIARY HEAT (HEAT PUMP SYSTEMS)	10
7.15	EMERGENCY HEAT (HEAT PUMP SYSTEMS)	10
7.16	COOLING	10
7.17	ECONOMIZER	10
7.18	ADD-ON HEAT PUMP	10

TABLE OF CONTENTS (CONTINUED)

8.	BYPASS SIZING CHART	10
9.	LOGIC PANEL BACKPLATE MOUNTING ILLUSTRATION	11
10.	TYPICAL SYSTEM DIAGRAM	12
11.	LOGIC PANEL OVERVIEW ILLUSTRATION	13
12.	LOGIC PANEL TERMINAL DESIGNATION ILLUSTRATION	14
13.	LOGIC PANEL TERMINAL DESIGNATION ILLUSTRATION FOR POWER – DETAIL A	15
14.	LOGIC PANEL TERMINAL DESIGNATION ILLUSTRATION FOR ZONE – DETAIL B	16
15.	LOGIC PANEL TERMINAL DESIGNATION ILLUSTRATION FOR MODE – DETAIL C	17
16.	LOGIC PANEL TERMINAL DESIGNATION ILLUSTRATION FOR INPUT – DETAIL D	18
17.	LOGIC PANEL TERMINAL DESIGNATION ILLUSTRATION FOR EQUIPMENT – DETAIL E AND FAN – DETAIL F	19
18.	LOGIC PANEL SWITCH LOCATIONS AND USER SETTINGS ILLUSTRATION ...	20
19.	LOGIC PANEL SWITCH LOCATIONS AND CONTROL SETTINGS FOR CONVENTIONAL HEAT/COOL OR HEAT PUMPS	21
20.	LOGIC PANEL SWITCH LOCATIONS AND CONTROL SETTINGS FOR UPSTAGE DELAY, UPSTAGE ZONES AND UPSTAGE AUXILIARY HEAT ...	22
21.	LOGIC PANEL SWITCH LOCATIONS AND CONTROL SETTINGS FOR G2 FAN OUTPUT	23
22.	LOGIC PANEL SWITCH LOCATIONS AND CONTROL SETTINGS FOR G2 ECONOMIZER AND TIME DELAY OVERRIDE	24
23.	CONTROL SETUP – INSIDE DOOR LABEL	25
24.	TERMINAL DESCRIPTIONS	26
25.	TEST, CHECK AND STARTUP PROCEDURES	27
26.	TROUBLESHOOTING GUIDE	28
27.	LOGIC PANEL SPECIFICATIONS	28
28.	WARRANTY INFORMATION	29

1. INTRODUCTION

The Robertshaw Slimzone Deluxe logic panel is designed for residential and light commercial constant volume heating and air conditioning zone control applications. The Deluxe panel incorporates a solid-state, microprocessor based logic board containing dedicated wiring terminals for interface with a single piece of heating and cooling equipment, zone thermostats, motorized zone dampers, and a wide range of optional peripheral devices.

The Slimzone Deluxe (2701-002) will control up to 3 individual zones and can be expanded to 7 zones in increments of two using Slimzone Deluxe Expander Modules (2701-003).

2. OPERATIONAL FEATURES

- Controls gas, oil, electric, add-on heat pump (duo fuel), or heat pump equipment
- Controls up to 2 stages of heating and 2 stages of cooling for heat/cool equipment
- Controls up to 3 stages of heating and 2 stages of cooling for heat pumps
- First call priority – timeshare control algorithm
- Switch selectable:
 - Time or numerical zone upstaging
 - Time upstage delay of 5, 10, 15, or 20 minutes
 - 45 second fan purge
 - Heat pump auxiliary heat upstage of 5, 10, or 20 minutes
 - G2 fan based on number of zones
 - G2 fan based on number of stages
 - Intermittent or continuous fan operation
 - Economizer power terminal using G2
 - On-board heat/auto/cool mode with dedicated terminals for external selector switch
 - On-board emergency heat with dedicated terminals for external SPST switch
 - Equipment switch (heat/cool, heat pump, add-on heat pump)
 - Plenum fan
- Computer controlled minimum on/off time delays to prevent equipment short cycling
- On-board time delay override button for test, check, and startup
- Dedicated terminals for:
 - Each 4 or 5 wire single stage zone thermostat
 - Independent power of each 2 or 3 wire motorized zone damper
 - Logic panel power
 - Ground (one only)
 - Zone damper power
 - High/low limit down staging
 - High/low balance point control
 - Occupied/unoccupied system scheduling clock
 - Smoke detector input
- LED (light emitting diode) indication for:
 - All system outputs
 - 24 volt power
 - When off time delay is active
 - Confirming normal operation
- Outputs are recoverable fuse protected (poly-switches)
- Ambient operating temperature range of 14° to 158° F (-10° to 70° C)

3. SAFETY INSTRUCTIONS

- Leave all primary power disconnected until installation is complete.
- Sharp metal edges may cause damage to wires. Use care during installation.
- All installation must be in compliance with local codes and regulations.
- Installer should touch a grounded metal object before handling any electronic components to avoid potential loss of internal computer programs due to static discharge.
- Use extreme care when handling any solid-state microprocessor device.

CAUTION:

To avoid short cycling of equipment, always disconnect HVAC equipment from the control panel before overriding time delay.

4. APPLICATION AND DESIGN CONSIDERATIONS

- All zone control installations require that the HVAC equipment be properly sized for the application to assure satisfactory temperature control and optimum system performance. Refer to Manual J or equivalent procedures to determine proper equipment sizing. Zone by zone load calculations are recommended.
- Use Manual D or equivalent to size ducts and select registers. Duct sizing is dependent on the following:
 - Total number of zones
 - Number of heating and cooling stages
 - Type of equipment
 - Indoor air movers (PSC motor or ICM/EMC motor)
 - Bypass air system
- Good HVAC design and a balanced air system are important criteria in all zone control applications.
- Zone thermostat location is a key priority. Remember, the thermostat controls the temperature and should be located within the zone and at a maximum distance from registers, return air grilles, and any internal or external influence that would cause a false temperature indication.
- Proper bypass air is critical in maintaining constant system static pressures. The Δp can be increased to the equipment manufacturer's maximum by decreasing airflow or by recirculating some of the air back to the return air using a bypass system.
- Air conditioning is equipment specific and dependent on coil frosting. The entering wet-bulb temperature and amount of cooling coil heat transfer surface will greatly influence the amount of bypass possible. Most systems must deliver 320 to 360 SCFM per ton to the space to prevent frosting. Low limit protection is always recommended in conjunction with a bypass system.
- Heat pump equipment is specific and dependent on mild weather trip-out limits. Air conditioning guidelines of 320 to 360 SCFM per ton should be applied to most systems.
- Entering air temperature to a blower motor should not exceed motor design temperatures. A motor fully loaded at maximum CFM and static pressure with the return opposite the motor should have an 85°F guideline. A lightly loaded motor facing into the return may be able to handle 110°F entering air temperature.
- High limit protection should be considered when the increase in air temperature across the heat exchanger exceeds the equipment manufacturer's high limit lockouts.

- Proper location of motorized zone dampers is important. Motorized zone dampers should be located on the trunk lines as close to the main supply plenum as possible or, when necessary, where branch lines intersect the trunk. This will greatly minimize air noise and reduce turbulence. Always make sure that zone dampers are accessible for service and/or replacement.
- Plenty of return air helps provide optimum results. It is recommended that each zone have its own return whenever possible. When this is not possible, the return air path from one zone should not influence any other zone thermostat. Sufficient return air is required to maintain proper zone control. Do not rely on free air infiltration for optimum results.
- Balancing dampers should be installed ahead of all motorized zone dampers.
- Whenever possible zone dampers should be installed 10 ft (3m) from discharge grilles and registers. Flex or lined duct is recommended on the last 5 ft (1.5m) to the grilles or registers.
- Pressure drop across the motorized zone damper is negligible and normally not a factor when sizing or calculating branch duct CFM.
- When HVAC equipment incorporates an economizer, it is recommended that the economizer be equipped with an air relief damper.
- Robertshaw motorized zone dampers are designed to work only with low pressure systems of 1.0 inches wg or less.
- Zone thermostats and motorized zone dampers may be located up to 300 ft (90m) from the Deluxe logic panel when 18AWG copper thermostat wire is used.
- The Deluxe system requires standard electromechanical or electronic heat/cool thermostats. Do not use heat pump thermostats. The control algorithm in the Deluxe logic panel is configured such that heat pump thermostats are not required.
- Maximum load allowed to be switched by the output terminals is 2.5 amps at 60°F (20°C). All outputs are protected by a current limiting device (poly-switch).

5. COMPONENT REQUIREMENTS

5.1 BASIC SYSTEM REQUIREMENTS

ITEM	QUANTITY	DESCRIPTION
2701-002	1	3 Zone Master Logic Panel
Panel Transformer	1	24VAC, 40VA
Zone Thermostat	1 per Zone	Single Stage Electro-mechanical* or Electronic
Motorized Zone Damper	1 per Zone Minimum	24VAC, 2 or 3 Wire
Damper Transformer	1 Minimum	24VAC, 12 VA per Zone Damper**

*Use with resistor kit

**More than one zone damper can be wired to a transformer as long as it has an acceptable VA rating. For example, 3 zone dampers would require a 24VAC, 40VA transformer

5.2 EXPANDED SYSTEM REQUIREMENTS

ITEM	QUANTITY	DESCRIPTION
2701-003	1 or 2	2 Zone Expander Board
Zone Thermostat	1 per Zone	Single Stage Electro-mechanical* or Electronic
Motorized Zone Damper	1 per Zone Minimum	24VAC, 2 or 3 Wire
Damper Transformer	1 Minimum	24VAC, 12 VA per Zone Damper**

*Use with resistor kit

**More than one zone damper can be wired to a transformer as long as it has an acceptable VA rating. For example, 3 zone dampers would require a 24VAC, 40VA transformer

5.3 OPTIONAL ITEMS FOR BOTH BASIC AND EXPANDED SYSTEM

ITEM	QUANTITY	DESCRIPTION
Outdoor Thermostat for HiBP	1	Thermostat must close connection when the outdoor temperature is above the setpoint temperature.
Outdoor Thermostat for LoBP	1	Thermostat must close connection when the outdoor temperature is below the setpoint.
Low Limit Duct Switch	1	Sensor must close the connection when the temperature is below the setpoint.
High Limit Duct Switch	1	Sensor must close the connection when the temperature is above the setpoint.
Clock	1	A timing device that closes the contacts when the system is switched into unoccupied mode.
Smoke Detector	1	Smoke detector that will close the contacts when smoke is detected.

6. SYSTEM INSTALLATION

6.1 UNPACKING THE 2701-002 LOGIC PANEL

Remove the 2701-002 from the shipping carton and protective bubble pack. **Touch a grounded metal object before handling the logic panel to avoid potential loss of operation due to static discharge.**

Open the access door by gently pulling on the bottom right corner. Apply finger pressure only. Once opened, the door may be removed by applying slight back pressure against the hinge tabs located on the panel base. To replace the door, align it with the hinge tabs and snap it back into place.

6.2 INSTALLING THE 2701-003 EXPANDER BOARD

In order to install the SlimZone Expander Board (2701-003) the bottom plastic piece of the SlimZone Master Board (2701-002) must be removed. This is done by removing the black plastic locking tabs and sliding the bottom piece away from the 2701-002. Align the top of the 2701-003 with either the bottom of the 2701-002 or 2701-003 above it. The top of the 2701-003 board is labeled as **TOP** and the bottom of the board is labeled as **BOTTOM**. Snap the cover portion into place and replace the black plastic locking tabs. Connect the (2) wire harnesses from the 2701-003 to either the 2701-002 or 2701-003 above it. Slide the bottom of the unit into place and replace the black plastic locking tabs.

6.3 INSTALLING THE BACKPLATE

The logic panel can be mounted on any dry interior surface. Use the mounting holes (see illustration on page 11) to secure in place using the supplied #8 screws. Mount the control panel in a location that provides easy access. Do not mount the control panel on any part of the HVAC equipment, duct work, or where moisture may be present. The back plate contains holes and knockouts for wall or surface wiring.

CAUTION:

Use care when removing upper or lower end cap knockouts. Apply a sharp rap with the blunt end of a screwdriver to remove knockouts. **Do not use sharp instruments in an attempt to remove the knockouts as internal damage to the PC board and/or components may occur.**

6.4 ZONE THERMOSTAT INSTALLATION

Zone thermostats should be installed in a location that best suits the general load characteristics of the space being controlled. Do not mount thermostats in hallways, on exterior walls, or near cold air returns, registers, or any other area where internal or external influences will cause false temperature indications. **Use only single stage, electromechanical or electronic thermostats. Do not use heat pump thermostats with this system. If an electromechanical thermostat is used, you will need to use a resistor kit.**

6.5 SYSTEM WIRING

The SlimZone Deluxe zone control system is designed to be used with #18 AWG (nonshielded) copper wire for all terminal landings. Zone thermostats and motorized zone dampers may be located up to 300 ft (90m) from the logic panel. **All system wires should be tagged for easy identification.**

IMPORTANT:

In order to avoid electrical interference to sensitive components, no wiring to the panel should cross over the panel.

6.6 LOGIC PANEL POWER SUPPLY

The Robertshaw SlimZone Deluxe logic panel requires a separate 24VAC, 40VA transformer. **Never use the equipment transformer or any other transformer used to power other devices.** Refer to the illustration on page 15, *Logic Panel Terminal Designation Illustration for Power – Detail A*.

6.7 MOTORIZED ZONE DAMPER POWER SUPPLY

A separate 24VAC transformer must be used to power motorized zone dampers and zone thermostats. Depending on the total number of zone dampers, multiple transformers may be used to comply with UL Class II. Each zone terminal has a dedicated 24L and 24N input to receive 24 Volt power for the damper(s) and zone thermostat. A minimum of 12VA is sufficient for each zone damper. As an example, when using Robertshaw motorized zone dampers that are rated at 12VA, a single 24VAC, 40VA transformer could be wired in parallel with up to three zones each having a single zone damper. Refer to the illustration on page 16, *Logic Panel Terminal Designation Illustration for Zone – Detail B*.

NOTE:

Some installations may require multiple dampers to be used on a single zone. The logic panel zone damper relays can handle up to five (5) Robertshaw motorized zone dampers for a total of 60VA per zone.

6.8 MOTORIZED ZONE DAMPER INSTALLATION

Robertshaw motorized zone dampers are designed to work with low pressure systems (1.0 inches wg or less). Balancing dampers should be installed ahead of all zone dampers. Whenever possible, zone dampers should be installed at least 10 ft (3m) from discharge grilles and registers. A flex or lined duct is recommended for the last 5 ft (1.5m). The pressure drop across typical control dampers is negligible and normally not a factor when sizing or calculating branch duct CFM. Robertshaw zone dampers are available in 2-wire, power close/spring return open or 3-wire, power close/power open configurations. Each zone terminal block has dedicated terminals for either a 2-wire or 3-wire damper input. Refer to the illustration on page 16, *Logic Panel Terminal Designation Illustration for Zone – Detail B*.

6.9 BYPASS DAMPER INSTALLATION

In order to maintain constant design static pressure, a bypass system is highly recommended. In some 2 zone applications, a bypass damper may not be required providing that each zone can be oversized to handle 75% of the total system CFM.

In applications where the equipment cooling tonnage is 5 tons or less, a Robertshaw barometric bypass damper can be applied.

In applications where the equipment cooling tonnage exceeds 5 tons, a motorized bypass damper and static pressure control must be incorporated.

Bypass dampers should be installed in the main supply plenum upstream from turning vanes, transitions, and zone dampers. Bypass air may be directed through rigid pipe to a common return air plenum or above the ceiling if this area is used as a common return. Refer to Bypass Sizing Chart, Page 10.

6.10 CURRENT LIMITED OUTPUT TERMINALS

All output circuits on the SlimZone Deluxe control panel incorporate a self-resetting current limiting device which provides protection against excessive current draws caused by circumstances such as wiring shorts on an output. This device, referred to as a poly-fuse, is activated in general when the current draw exceeds 2.5 amps. The value and the duration of the excess current is taken into account. The poly-fuse will allow excess currents of very short duration (i.e., spikes) in order to prevent circuit interruption by noisy lines or occasional minor surges. In its current limiting mode, the poly-fuse reduces the output current to milliamps.

Notes:

- The low leakage current may be sufficient to produce a small voltage reading when measured with a volt meter with a high input impedance.
- When the cause of the excess current has been removed and the current draw is returned to a value below 2.5 amps at 68°F (20°C), the poly-fuse will reestablish full output current; in some instances this may take up to twenty seconds. The poly-fuse eliminates the need to replace blown fuses.
- Refer to the Logic Panel Specifications Section (Page 28) for the current ratings and other environmental temperatures.

6.11 LED

There are 11 LEDs on the SlimZone Deluxe Master Board. The normal LED is green, and indicates the panel is functioning normally when it is flashing. The delay LED is yellow and indicates the delay function is active when it is on. There are 3 green zone LEDs located to the right of each zone terminal. The damper is open when the green LED is on. There are 2 red LEDs for W1 and W2/O/B. The equipment is powered when the red LED(s) are on. There are 2 yellow LEDs for Y1 and Y2. The equipment is powered when the yellow LED(s) are on. There are 2 green LEDs for G1 and G2. The equipment is powered when the green LED(s) are on.

There are 3 LEDs on the SlimZone Deluxe Expander Board. The normal LED is green; the expander board is connected properly when this LED is flashing. There are 2 green zone LEDs located to the right or left of each zone terminal. The damper is open when the green LED is on.

7. ROBERTSHAW SLIMZONE DELUXE SEQUENCE OF OPERATION

7.1 INITIAL POWER UP

Unless the SW7 Time Delay Override button is depressed, all minimum OFF time delays are initiated on power up. Four minutes must elapse before the first stage compressor will be energized. A minimum of 2 minutes must elapse before heating will be energized including emergency heat for heat pumps. However, the fan output can be energized during the time delay period.

7.2 REVERSING VALVE OPERATION

The O/B terminal can be configured as O or B. The factory O/B default is set to cooling (O). Reversing valve output does not change upon satisfying a conditioning mode. When the operating mode is switched (heat/cool), the reversing valve output is switched without deenergizing the compressor output.

7.3 FAN OPERATION

When any zone thermostat is initiated in the continuous fan mode, the G input terminal will be activated. Only zones with thermostats calling for constant fan will receive ventilation air. When an equipment call takes place, the fan will run intermittently with the equipment mode of operation and the calling zone(s). After a call is satisfied and depending on the fan purge selection, ventilation air then will be distributed to the zone thermostats set in the continuous fan mode. The Robertshaw SlimZone Deluxe also features an on-board continuous fan option switch or dedicated terminal that can be used with a time clock to schedule continuous fan operation. If continuous fan is selected via SW3 or the FAN input, all zones will receive ventilation until an equipment call takes place.

The G2 output terminal may be used as second stage fan. G2 may be selected to activate based on number of zones calling or number of equipment stages energized. Refer to the illustration on page 23, *Logic Panel Switch Locations and Control Settings for G2 Fan Output*.

7.4 GENERAL CONTROL ALGORITHM

The Robertshaw SlimZone Deluxe logic panel uses a first call priority/timeshare algorithm. Any zone that calls for conditioned air prioritizes the equipment mode of operation. In the event a simultaneous heating/cooling call takes place, the factory default will prioritize heating. Equipment upstaging takes place when a zone continuously calls for conditioned air beyond a selected preset threshold. The timeshare portion of the algorithm is designed to prevent an equipment mode from exceeding 20 minutes from start time if and only if an opposite call takes place.

7.5 MINIMUM ON/OFF TIME DELAYS

When the HVAC equipment is energized in heating, the minimum ON time is 2 minutes. After the equipment is deenergized, the minimum OFF time is 2 minutes. When the HVAC equipment is energized in cooling, the minimum ON time is 4 minutes. When the HVAC equipment is deenergized, the minimum OFF time is 4 minutes. When the system is set up for heat pumps, the minimum ON/OFF time for heating and cooling is 4 minutes.

7.6 FAN PURGE

A fan purge of 45 seconds may be selected for heating, cooling, or both. Fan purge can also be disabled. During a fan purge cycle, if any zone calls in the previous mode, the receiving zone damper(s) will be driven closed and the calling zone damper will be opened.

7.7 TIME UPSTAGING

The factory default upstage setting for multistage equipment is 5 minutes. The upstage time may be adjusted from 5, 10, 15, or 20 minutes. Refer to the illustration on page 22, *Logic Panel Switch Locations and Control Settings for Upstage Delay, Upstage Zones, and Upstage Auxiliary Heat*.

7.8 ZONE UPSTAGING

Upstaging can be based on a selected number of zones calling instead of time. Upstaging to second and third stages may be set to 2 zones and 3 zones, 3 zones and 5 zones, 3 zones and 6 zones, and finally 4 zones and 7 zones, respectively. Zone upstaging also provides an adjustable time delay for auxiliary heat when used with a heat pump system of 5, 10, 15, or 20 minutes. Refer to the illustration on page 22, *Logic Panel Switch Locations and Control Settings for Upstage Delay, Upstage Zones, and Upstage Auxiliary Heat*.

7.9 HIGH AND LOW LIMIT TERMINALS

High and low limit terminals are provided to protect equipment against extreme discharge air temperatures. An independent high and low limit control is recommended to protect the HVAC equipment from these conditions. When a limit setting is reached, the highest active stage is immediately turned off. If the discharge air temperature continues to reach the limit setting after five minutes, the next highest active stage is turned off. In a single stage application, the system will be turned off immediately. After the first stage is turned off, the fan will continue to run for five minutes or until the limit input is no longer active. Limit controls are connected to the HLIM, LLIM, and LIMC terminals on the panel. Refer to the illustration on page 18, *Logic Panel Terminal Designation Illustration for Input – Detail D*.

7.10 HIGH BALANCE POINT (HI BP) (ODT) TERMINALS

Two terminals, BPC and HBP, are provided to connect an outdoor thermostat (ODT). When the terminals are closed by the ODT, the logic panel will prevent the auxiliary heat from energizing as long as the outdoor ambient temperature is above the high BP (high balance point) setting.

7.11 LOW BALANCE POINT (LOW BP) TERMINALS

A terminal designated LBP in conjunction with terminal BPC may be used with an outdoor thermostat (ODT). When the terminals are closed by the ODT, the logic panel will prevent the heat pump from energizing and will energize the auxiliary heat as long as the outdoor ambient temperature is below the low BP (low balance point) setting.

7.12 CLOCK TERMINALS

Terminals designated CLK and SCC may be used with a variety of time/temperature devices to provide occupied/unoccupied scheduling of the entire zone system. When the terminals are closed, system calls are disabled, all dampers are opened, and the economizer (if selected) is closed.

7.13 SMOKE DETECTOR TERMINALS

Terminals designated SMK and SCC may be used with a smoke detector. When the terminals are closed, 24-volt power from the logic panel to the equipment will be disrupted and all 3-wire zone dampers will be powered to the closed position. **If a smoke detector interrupts primary power to the system, the logic panel will not be able to power the 3-wire dampers to the closed position.**

7.14 AUXILIARY HEAT (HEAT PUMP SYSTEMS)

Before auxiliary heat is energized, a 5-minute (factory default) time limit is initiated on a call for heating. However, this time may be adjusted to 5, 10, 15, or 20 minutes. The time delay will not apply when the system is switched to emergency heat or when the low BP is activated. Under these conditions, the auxiliary heat will act as the primary heat source and will function as first stage heating.

7.15 EMERGENCY HEAT (HEAT PUMP SYSTEMS)

Emergency heat is activated by an on-board selector switch or through a remote switch wired to terminals EH and SWCOM. When emergency heat is selected, the compressor is deenergized and all heating calls are acknowledged through the auxiliary heat source (W1). Cooling calls are ignored when the system is in the emergency heat mode.

7.16 COOLING

Calls for cooling will energize the equipment when the logic panel is set in the cool or auto changeover mode. If the HVAC system is idle because of a minimum off time or initial power up, and both heat and cool calls take place, heating will receive the priority providing the logic panel is set in the auto changeover mode of operation.

7.17 ECONOMIZER

An output terminal controls the economizer power to close it during the unoccupied cycle (clock input is active). Both power open and power closed options are provided for.

7.18 ADD-ON HEAT PUMP

If the add-on DIP switch is selected, the compressor will be turned off when the panel energizes auxiliary heat. The NORMAL position will allow auxiliary heat while the compressor is still running.

8. BYPASS SIZING CHART

COOLING TONNAGE	BYPASS DAMPER SIZE
3 to 3.5	10"
4 to 5	12"
7.5 to 10	14"
12.5	16"
15 to 17.5	18"
20	14" x 2 dampers
25	16" x 2 dampers
30	18" x 2 dampers

9. LOGIC PANEL BACKPLATE MOUNTING ILLUSTRATION

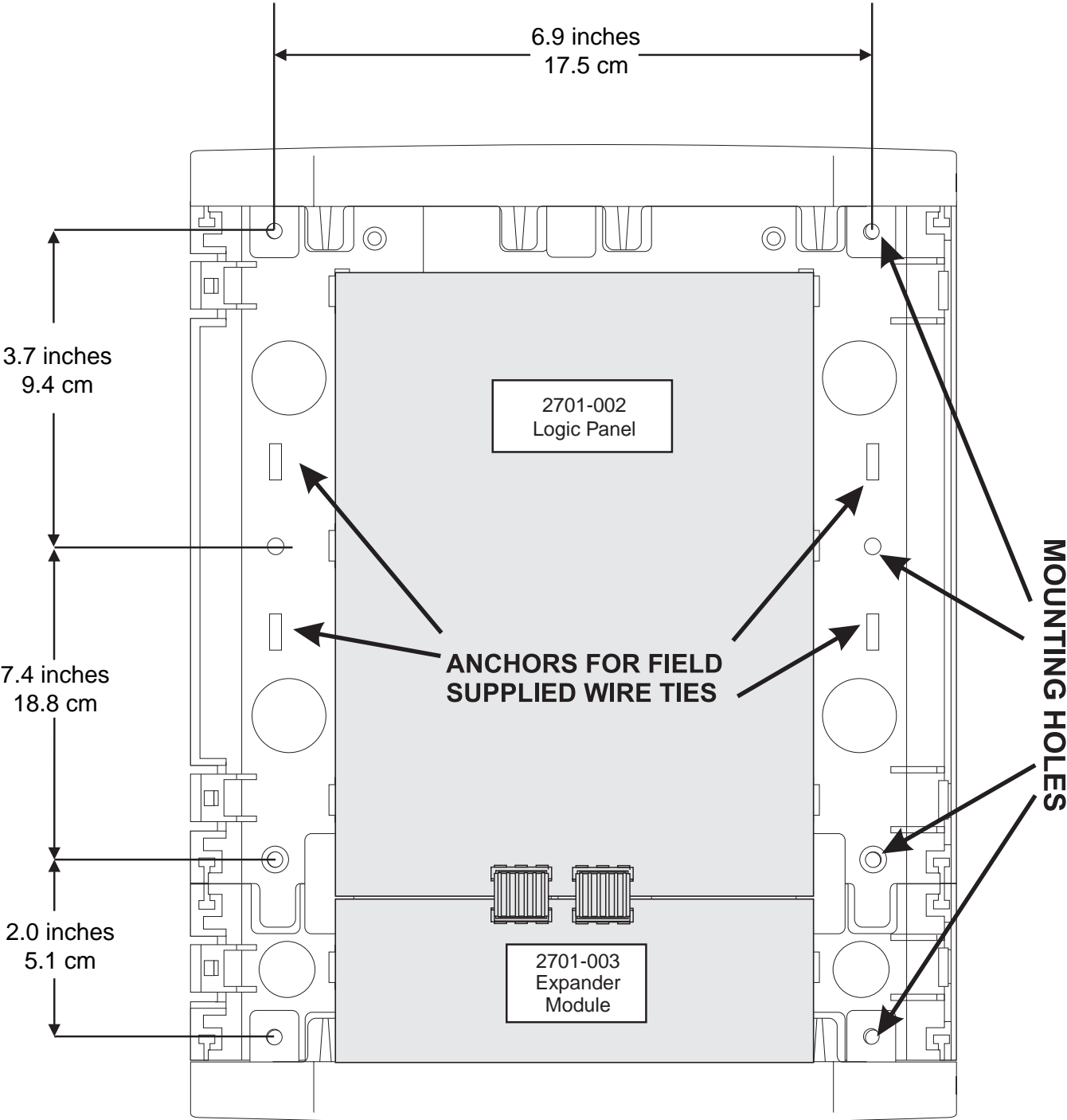

10. TYPICAL SYSTEM DIAGRAM

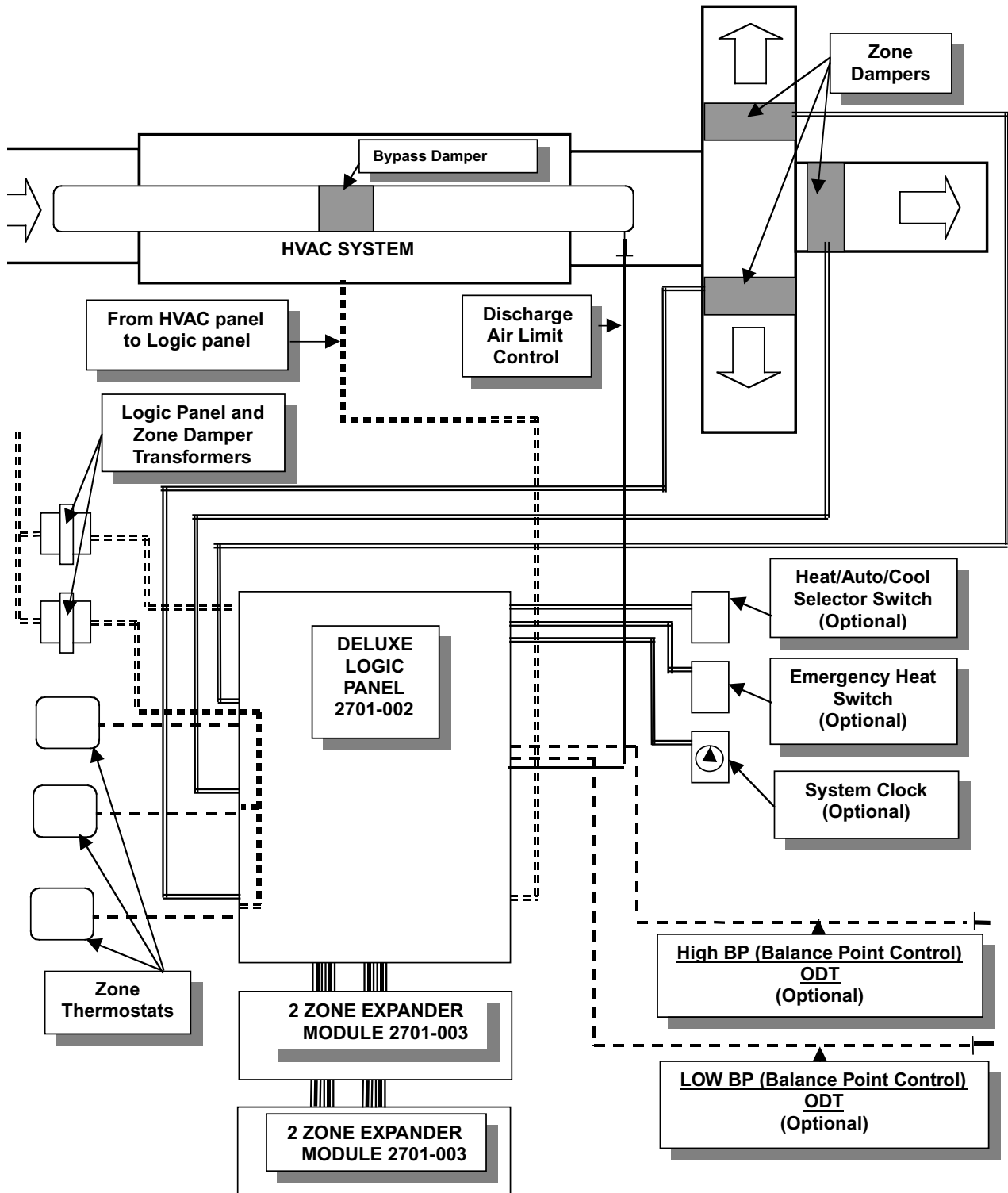

11. LOGIC PANEL OVERVIEW ILLUSTRATION

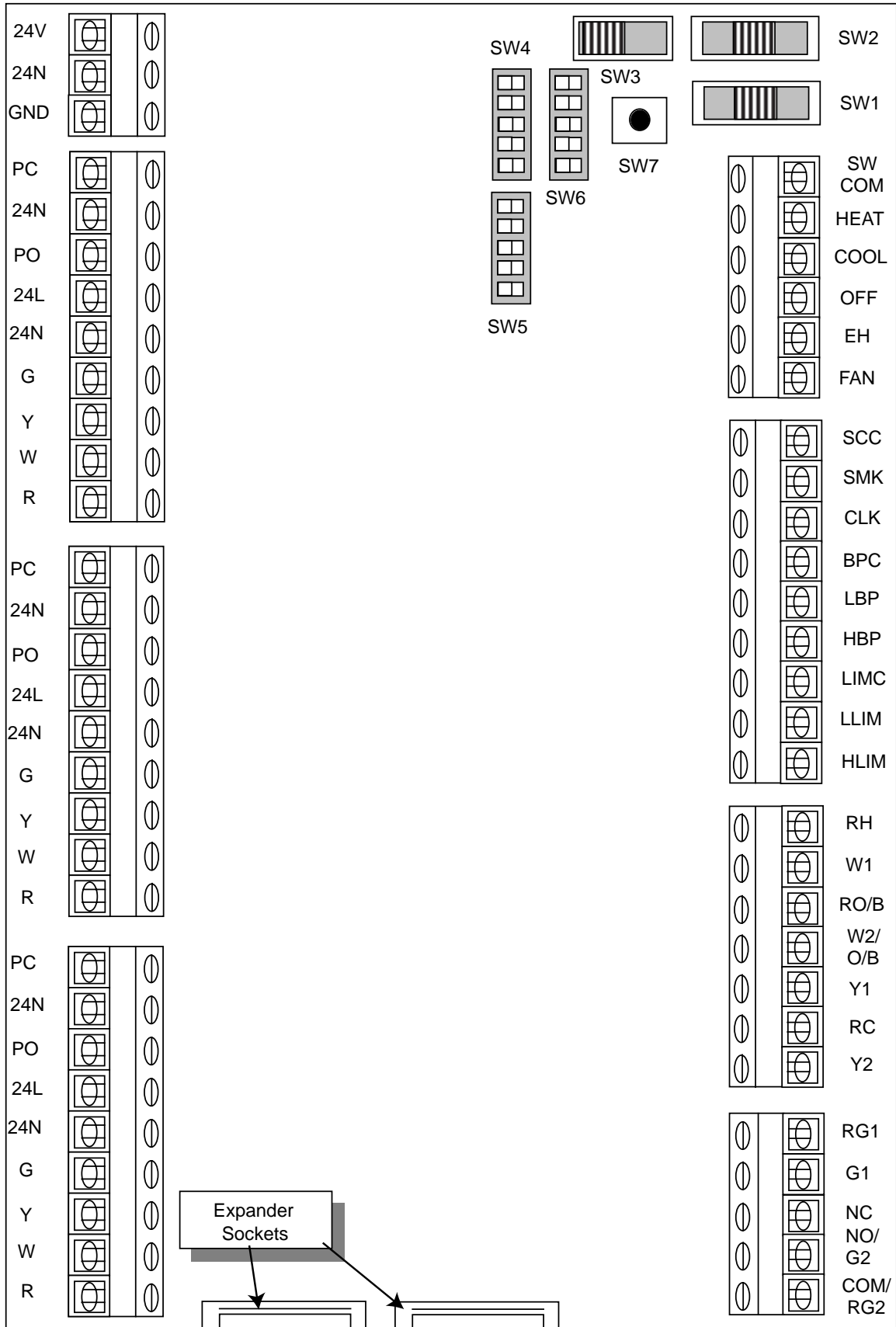

12. LOGIC PANEL TERMINAL DESIGNATION ILLUSTRATION

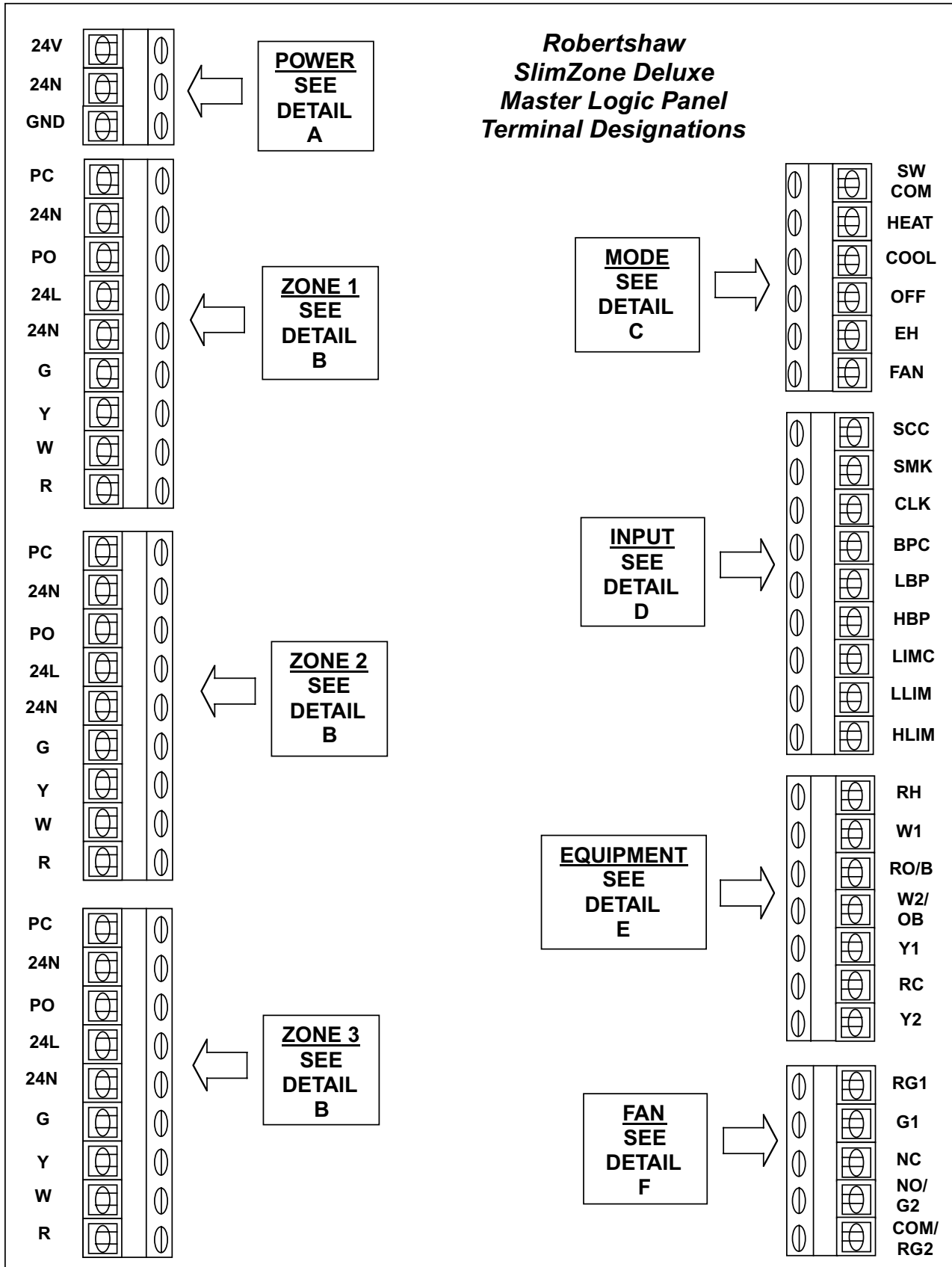

13. LOGIC PANEL POWER TERMINAL DESIGNATION ILLUSTRATION

Robertshaw SlimZone Deluxe Master Logic Panel

POWER DETAIL A

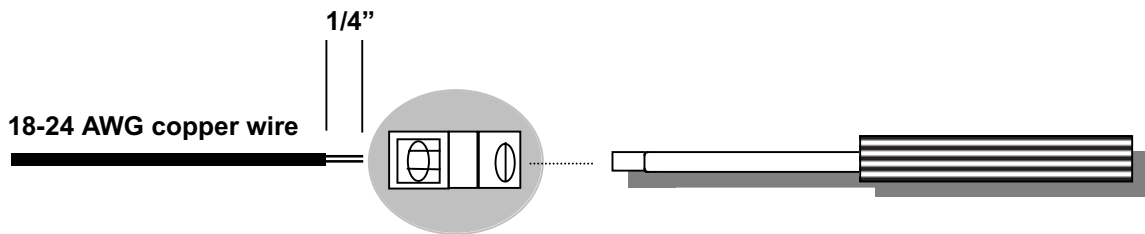
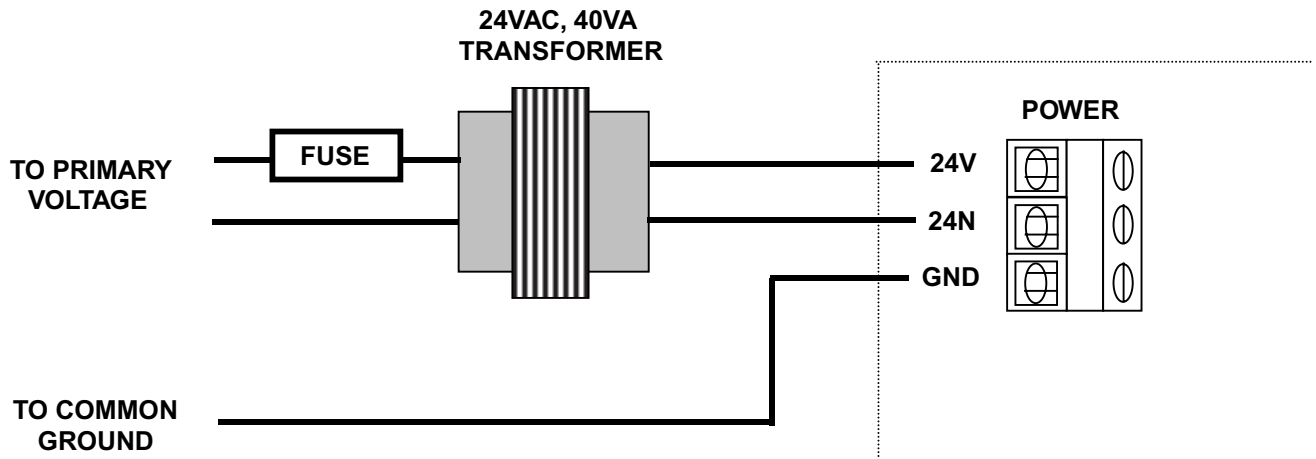

NOTE: Use standard nonshielded 18-24 AWG copper wire for all terminal landings. Strip wire insulation no more than 1/4" and after landing wire to designated terminal, use a proper sized flat bladed screwdriver to secure the wire.

CAUTION! Do not use excessive force when tightening the terminal screws as terminal block connections to the printed circuit board could crack or break.

14. LOGIC PANEL ZONE TERMINAL DESIGNATION ILLUSTRATION

Robertshaw SlimZone Deluxe Master Logic Panel

ZONE Detail B

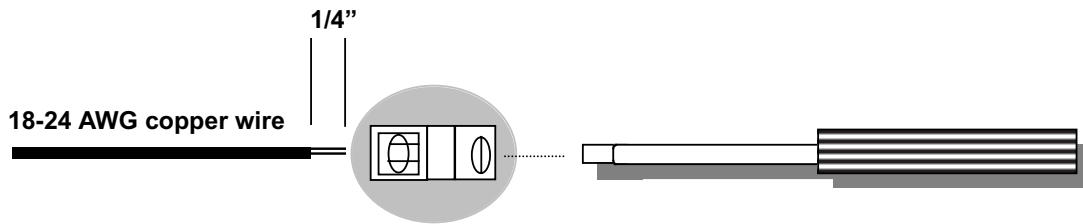
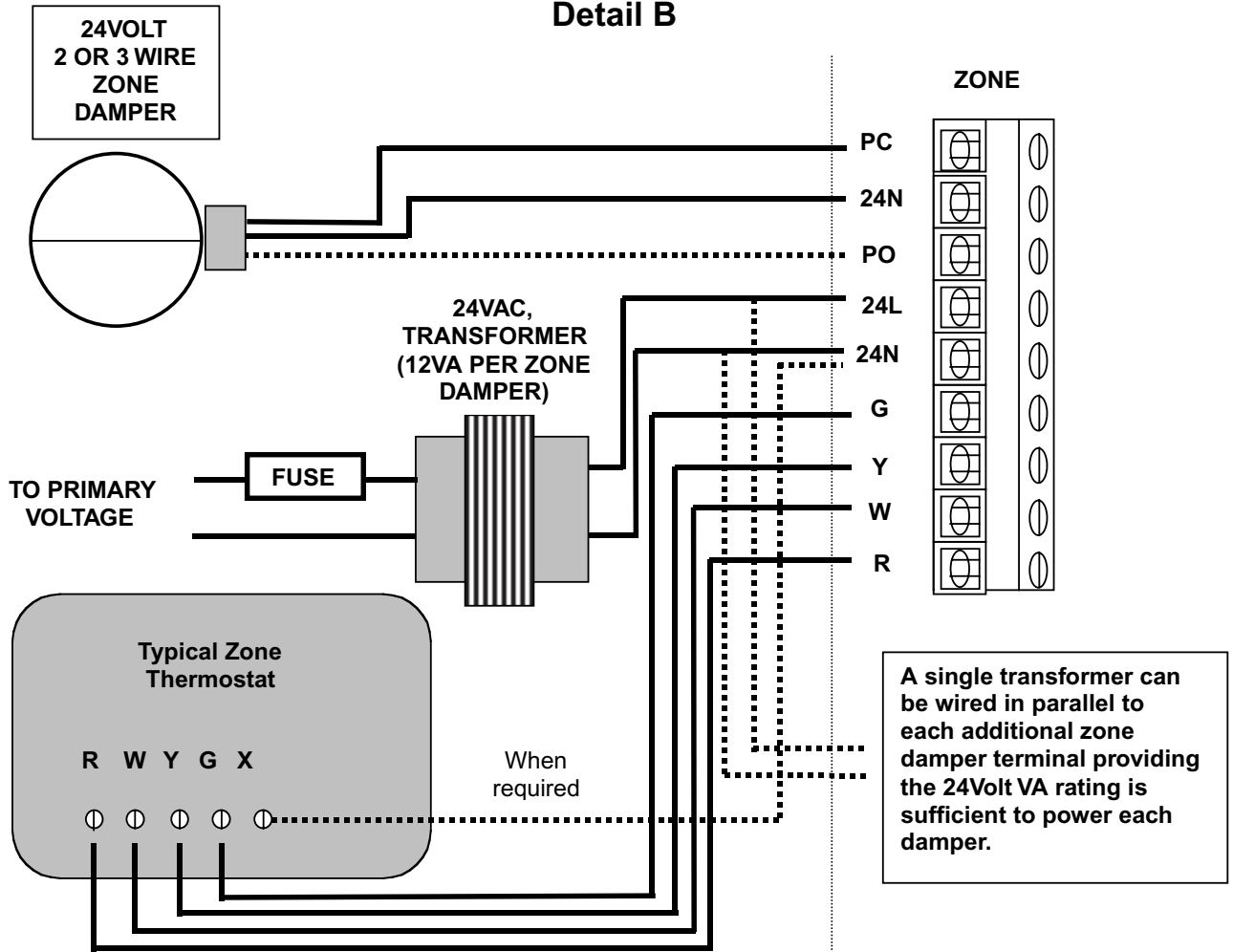

NOTE: Use standard nonshielded 18-24 AWG copper wire for all terminal landings. Strip wire insulation no more than 1/4" and after landing wire to designated terminal, use a proper sized flat bladed screwdriver to secure the wire.

CAUTION! Do not use excessive force when tightening the terminal screws as terminal block connections to the printed circuit board could crack or break.

15. LOGIC PANEL TERMINAL DESIGNATION ILLUSTRATION

Robertshaw SlimZone Deluxe Master Logic Panel

MODE Detail C

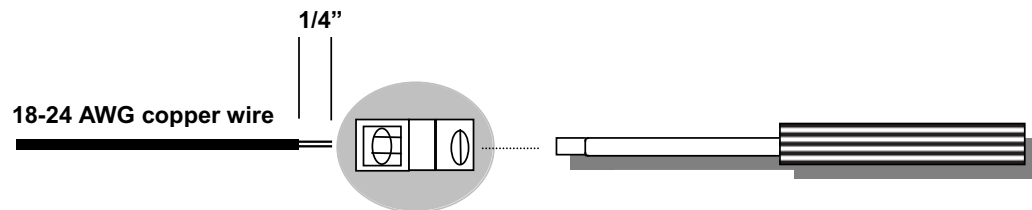
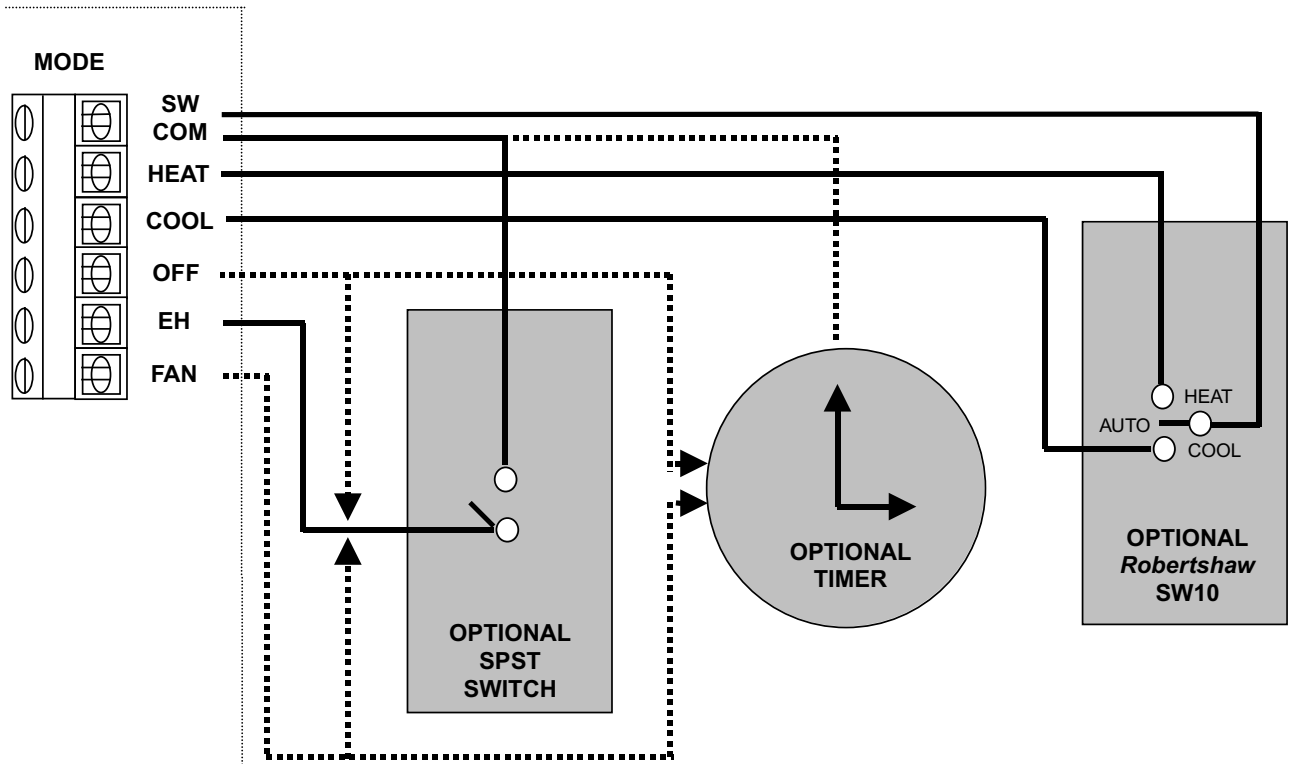

NOTE: Use standard nonshielded 18-24 AWG copper wire for all terminal landings. Strip wire insulation no more than 1/4" and after landing wire to designated terminal, use a proper sized flat bladed screwdriver to secure the wire.

CAUTION! Do not use excessive force when tightening the terminal screws as terminal block connections to the printed circuit board could crack or break.

16. LOGIC PANEL TERMINAL DESIGNATION ILLUSTRATION

Robertshaw SlimZone Deluxe Master Logic Panel

INPUT Detail D

NOTE: All input terminals are for normally open, dry contact closure devices.

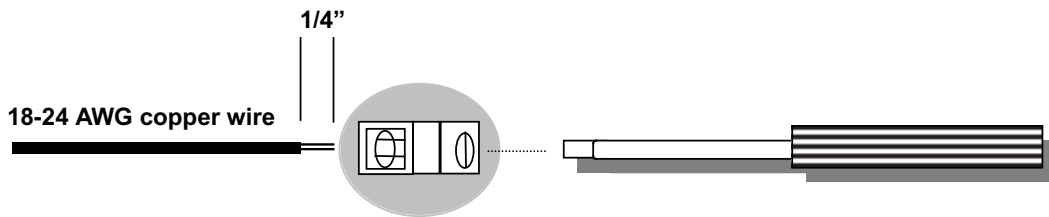
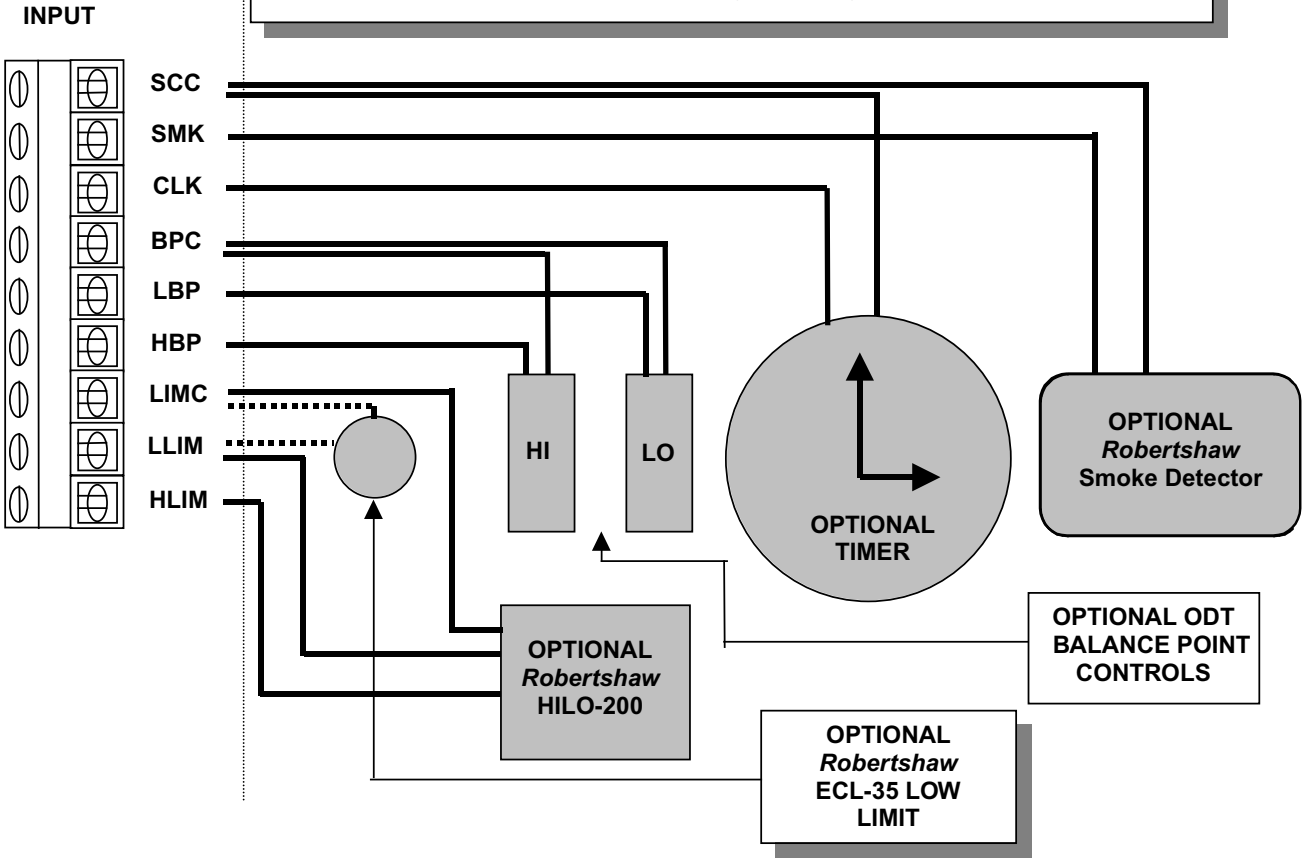

NOTE: Use standard nonshielded 18-24 AWG copper wire for all terminal landings. Strip wire insulation no more than 1/4" and after landing wire to designated terminal, use a proper sized flat bladed screwdriver to secure the wire.

CAUTION! Do not use excessive force when tightening the terminal screws as terminal block connections to the printed circuit board could crack or break.

17. LOGIC PANEL EQUIPMENT AND FAN TERMINAL DESIGNATIONS

Robertshaw SlimZone Deluxe Master Logic Panel

EQUIPMENT Detail E and FAN Detail F

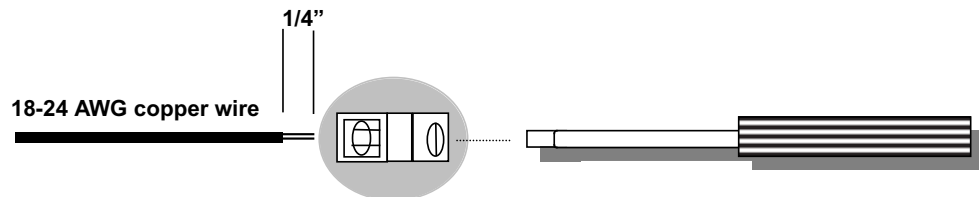
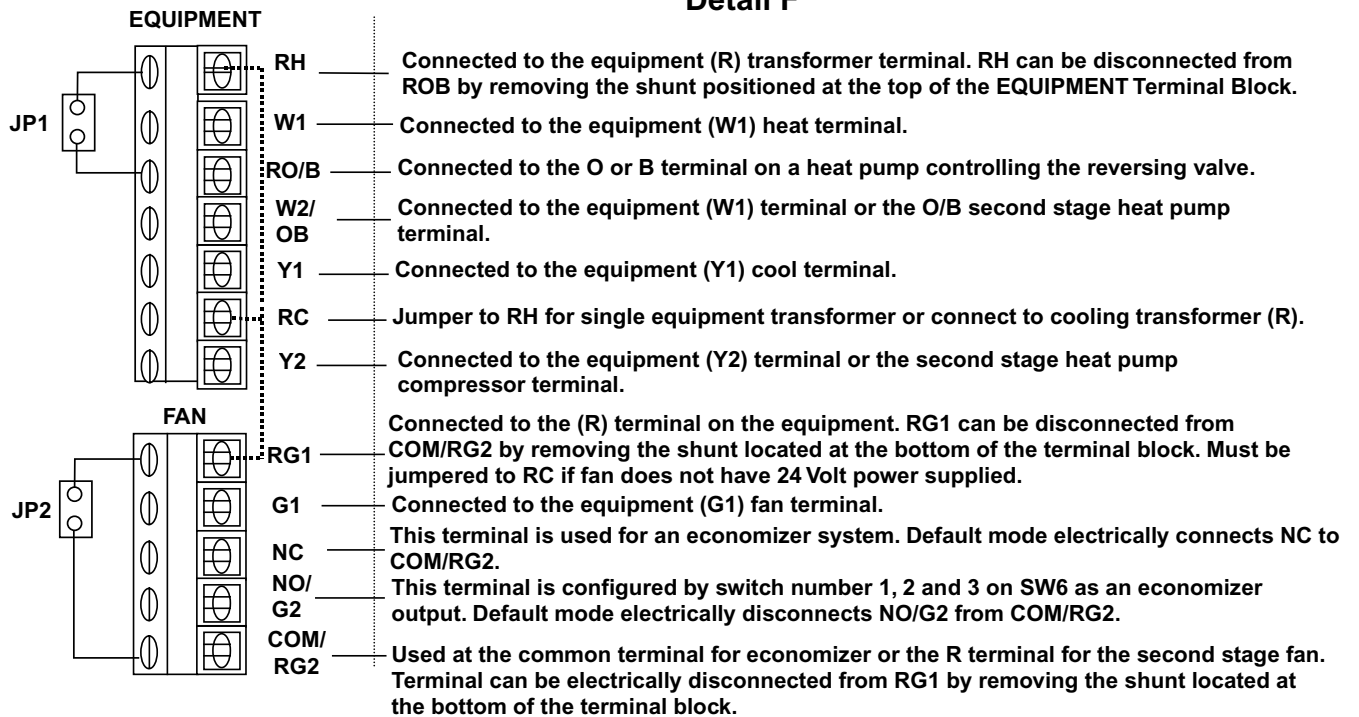

NOTE: Use standard nonshielded 18-24 AWG copper wire for all terminal landings. Strip wire insulation no more than 1/4" and after landing wire to designated terminal, use a proper sized flat bladed screwdriver to secure the wire.

CAUTION! Do not use excessive force when tightening the terminal screws as terminal block connections to the printed circuit board could crack or break.

18. LOGIC PANEL SWITCH LOCATIONS AND USER SETTINGS ILLUSTRATION

**Robertshaw
SlimZone Deluxe
Switch Locations
and
User Settings**

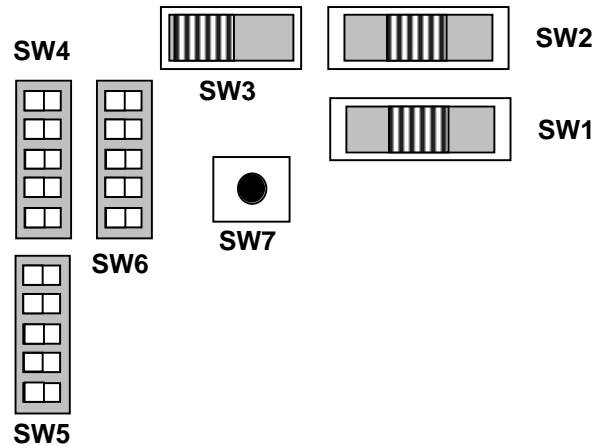

SWITCH NUMBER	SWITCH POSITION	OPERATION
SW1	1 2 3	NORMAL
SW1	1 2 3	SYSTEM OFF
SW1	1 2 3	EMERGENCY HEAT
SW2	1 2 3	AUTO CHANGEOVER MODE
SW2	1 2 3	HEAT ONLY MODE
SW2	1 2 3	COOL ONLY MODE
SW3	1 2	INTERMITTENT FAN OPERATION
SW3	1 2	CONTINUOUS FAN OPERATION

19. LOGIC PANEL SWITCH LOCATIONS AND CONTROL SETTINGS FOR CONVENTIONAL HEAT/COOL SYSTEMS OR HEAT PUMPS

**Robertshaw
SlimZone Deluxe
Switch Locations
and
Control Settings
for
Conventional
Heat/Cool Systems
or
Heat Pumps**

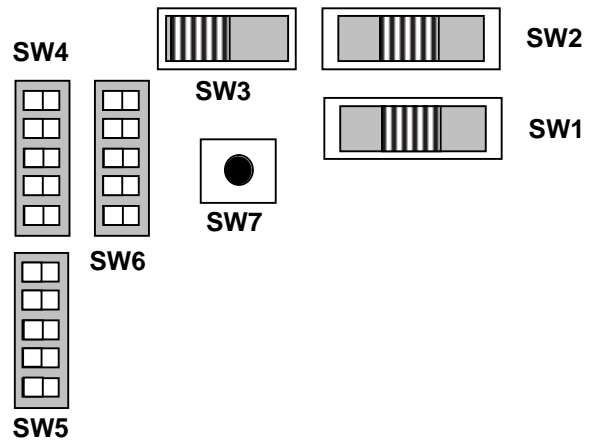

SWITCH LOCATION	SWITCH VIEW	SWITCH NUMBER	ON	OFF	CONVENTIONAL HEAT/COOL SYSTEM
SW4		1	<input type="checkbox"/>	<input checked="" type="checkbox"/>	Conventional System
		2	<input type="checkbox"/>	<input checked="" type="checkbox"/>	Plenum Fan Disabled
		2	<input type="checkbox"/>	<input type="checkbox"/>	Plenum Fan Enabled
		3	<input type="checkbox"/>	<input checked="" type="checkbox"/>	Single Stage Cooling
		3	<input type="checkbox"/>	<input type="checkbox"/>	Two Stage Cooling
		4	<input type="checkbox"/>	<input checked="" type="checkbox"/>	Single Stage Heating
		4	<input type="checkbox"/>	<input type="checkbox"/>	Two Stage Heating
		5	<input type="checkbox"/>	<input checked="" type="checkbox"/>	No Function

SWITCH LOCATION	SWITCH VIEW	SWITCH NUMBER	ON	OFF	HEAT PUMPS
SW4		1	<input type="checkbox"/>	<input type="checkbox"/>	Heat Pump
		2	<input type="checkbox"/>	<input checked="" type="checkbox"/>	O Energized in Cool
		2	<input type="checkbox"/>	<input type="checkbox"/>	B Energized in Heat
		3	<input type="checkbox"/>	<input checked="" type="checkbox"/>	Single Compressor
		3	<input type="checkbox"/>	<input type="checkbox"/>	Two Compressors
		4	<input type="checkbox"/>	<input checked="" type="checkbox"/>	No Auxiliary Heat
		4	<input type="checkbox"/>	<input type="checkbox"/>	Auxiliary Heat
		5	<input type="checkbox"/>	<input checked="" type="checkbox"/>	Normal Heat Pump
		5	<input type="checkbox"/>	<input type="checkbox"/>	Add-On Heat Pump

20. LOGIC PANEL SWITCH LOCATIONS AND CONTROL SETTINGS FOR UPSTAGE DELAY, UPSTAGE ZONES AND UPSTAGE AUXILIARY HEAT

**Robertshaw
SlimZone Deluxe
Switch Locations
and
Control Settings
for
Upstage Delay
Upstage Zones
Upstage Auxiliary Heat**

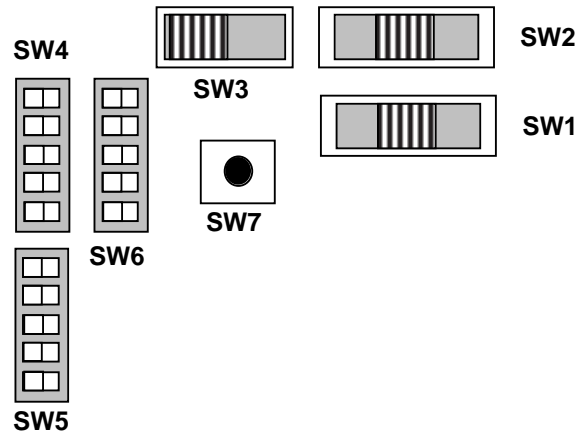

SWITCH LOCATION	SWITCH VIEW	SWITCH NUMBERS										UPSTAGE BY TIME
		1		2		3		4		5		
		ON	OFF	ON	OFF	ON	OFF	ON	OFF	ON	OFF	
SW5		<input type="checkbox"/>	<input checked="" type="checkbox"/>	<input type="checkbox"/>	<input checked="" type="checkbox"/>	<input type="checkbox"/>	<input checked="" type="checkbox"/>	<input type="checkbox"/>	<input checked="" type="checkbox"/>	<input type="checkbox"/>	<input checked="" type="checkbox"/>	5 Minutes
		<input checked="" type="checkbox"/>	<input type="checkbox"/>	<input checked="" type="checkbox"/>	<input type="checkbox"/>	<input type="checkbox"/>	<input type="checkbox"/>	<input checked="" type="checkbox"/>	<input type="checkbox"/>	<input checked="" type="checkbox"/>	<input type="checkbox"/>	10 Minutes
		<input checked="" type="checkbox"/>	<input type="checkbox"/>	<input type="checkbox"/>	<input type="checkbox"/>	<input checked="" type="checkbox"/>	<input type="checkbox"/>	<input checked="" type="checkbox"/>	<input type="checkbox"/>	<input checked="" type="checkbox"/>	<input type="checkbox"/>	15 Minutes
		<input checked="" type="checkbox"/>	<input type="checkbox"/>	<input type="checkbox"/>	<input type="checkbox"/>	<input type="checkbox"/>	<input type="checkbox"/>	<input checked="" type="checkbox"/>	<input type="checkbox"/>	<input checked="" type="checkbox"/>	<input type="checkbox"/>	20 Minutes

SWITCH LOCATION	SWITCH VIEW	SWITCH NUMBERS										UPSTAGE BY ZONE
		1		2		3		4		5		
		ON	OFF	ON	OFF	ON	OFF	ON	OFF	ON	OFF	
SW5		<input type="checkbox"/>	<input type="checkbox"/>	<input type="checkbox"/>	<input checked="" type="checkbox"/>	<input type="checkbox"/>	<input checked="" type="checkbox"/>	<input type="checkbox"/>	<input checked="" type="checkbox"/>	<input type="checkbox"/>	<input checked="" type="checkbox"/>	2&3 ZONES
		<input type="checkbox"/>	<input type="checkbox"/>	<input type="checkbox"/>	<input checked="" type="checkbox"/>	<input type="checkbox"/>	<input type="checkbox"/>	<input checked="" type="checkbox"/>	<input type="checkbox"/>	<input checked="" type="checkbox"/>	<input type="checkbox"/>	3&5 ZONES
		<input type="checkbox"/>	<input type="checkbox"/>	<input type="checkbox"/>	<input type="checkbox"/>	<input type="checkbox"/>	<input checked="" type="checkbox"/>	<input type="checkbox"/>	<input checked="" type="checkbox"/>	<input type="checkbox"/>	<input checked="" type="checkbox"/>	3&6 ZONES
		<input type="checkbox"/>	<input type="checkbox"/>	<input type="checkbox"/>	<input type="checkbox"/>	<input type="checkbox"/>	<input type="checkbox"/>	<input type="checkbox"/>	<input checked="" type="checkbox"/>	<input type="checkbox"/>	<input checked="" type="checkbox"/>	4&7 ZONES

SWITCH LOCATION	SWITCH VIEW	SWITCH NUMBERS										AUX HEAT DELAY
		1		2		3		4		5		
		ON	OFF	ON	OFF	ON	OFF	ON	OFF	ON	OFF	
SW5		<input type="checkbox"/>	<input checked="" type="checkbox"/>	<input type="checkbox"/>	<input checked="" type="checkbox"/>	<input type="checkbox"/>	<input checked="" type="checkbox"/>	<input type="checkbox"/>	<input checked="" type="checkbox"/>	<input type="checkbox"/>	<input checked="" type="checkbox"/>	5 Minutes
		<input checked="" type="checkbox"/>	<input type="checkbox"/>	<input checked="" type="checkbox"/>	<input type="checkbox"/>	<input checked="" type="checkbox"/>	<input type="checkbox"/>	<input checked="" type="checkbox"/>	<input type="checkbox"/>	<input type="checkbox"/>	<input type="checkbox"/>	10 Minutes
		<input checked="" type="checkbox"/>	<input type="checkbox"/>	<input checked="" type="checkbox"/>	<input type="checkbox"/>	<input checked="" type="checkbox"/>	<input type="checkbox"/>	<input type="checkbox"/>	<input type="checkbox"/>	<input type="checkbox"/>	<input checked="" type="checkbox"/>	15 Minutes
		<input checked="" type="checkbox"/>	<input type="checkbox"/>	<input type="checkbox"/>	<input type="checkbox"/>	<input checked="" type="checkbox"/>	<input type="checkbox"/>	<input type="checkbox"/>	<input type="checkbox"/>	<input type="checkbox"/>	<input type="checkbox"/>	20 Minutes

21. LOGIC PANEL SWITCH LOCATIONS AND CONTROL SETTINGS FOR G2 FAN OUTPUT

**Robertshaw
SlimZone Deluxe
Switch Locations
and
Control Settings
for
G2 Fan Output**

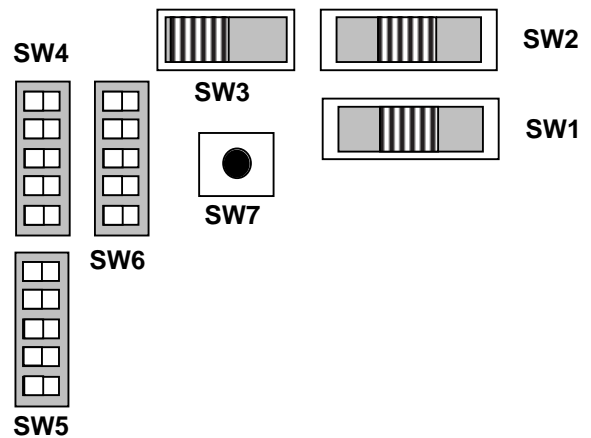

SWITCH LOCATION	SWITCH VIEW	SWITCH NUMBERS										G2 FAN BY STAGE
		1		2		3		4		5		
		ON	OFF	ON	OFF	ON	OFF	ON	OFF	ON	OFF	
SW6			■		■		■		■		■	2 Stages
			■		■	□				■		■

SWITCH LOCATION	SWITCH VIEW	SWITCH NUMBERS										G2 FAN BY ZONE
		1		2		3		4		5		
		ON	OFF	ON	OFF	ON	OFF	ON	OFF	ON	OFF	
SW6			■		■		■		■		■	2 ZONES
			■		■		■		■	□		3 ZONES
		□			■		■		■		■	4 ZONES
		□			■	□			■		■	5 ZONES
		□		□			■		■		■	6 ZONES

SWITCH LOCATION	SWITCH VIEW	SWITCH NUMBERS										FAN PURGE
		1		2		3		4		5		
		ON	OFF	ON	OFF	ON	OFF	ON	OFF	ON	OFF	
SW6			■		■		■		■		■	None
			■		■		■		■	□		Heat Only
			■		■		■	□			■	Cool Only
			■		■		■	□		□		Heat/Cool

22. LOGIC PANEL SWITCH LOCATIONS AND CONTROL SETTINGS FOR G2 ECONOMIZER AND TIME DELAY OVERRIDE

**Robertshaw
SlimZone Deluxe
Switch Locations
and
Control Settings
for
G2 ECONOMIZER
and
Time Delay Override**

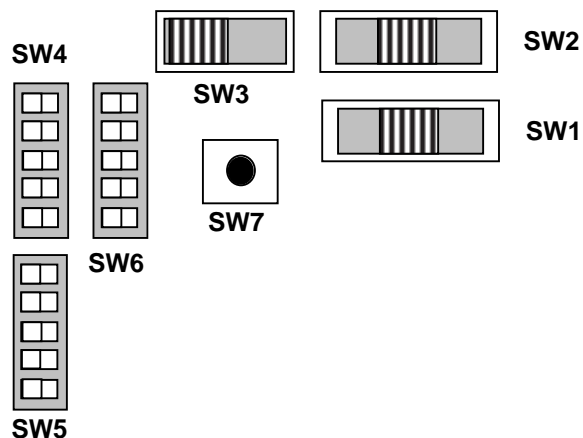

SWITCH LOCATION	SWITCH VIEW	SWITCH NUMBERS										G2 AS ECONOMIZER	
		1		2		3		4		5			
		ON	OFF	ON	OFF	ON	OFF	ON	OFF	ON	OFF		
SW6													G2 Relay Energizes Economizer Circuit

SW7		<p>TIME DELAY OVERRIDE Depress and hold WARNING! Do not operate equipment in override mode</p>
-----	--	--

23. CONTROL SETUP — INSIDE DOOR LABEL

Control Setup



User Settings (All other settings require qualified technician)

EMERGENCY HEAT/OFF

SW1

1 2 3
 EH

1 2 3
 NORMAL

1 2 3
 OFF

MODE

SW2

1 2 3
 COOL

1 2 3
 AUTO

1 2 3
 HEAT

SW1 MUST BE IN NORMAL MODE

FAN

SW3

1 2
 INTERMITTENT FAN

1 2
 CONTINUOUS FAN

DELAY OVERRIDE

PB1

OPERATIONAL

DELAY OVERRIDE (PRESS AND HOLD)

WARNING :
DISCONNECT EQUIPMENT BEFORE USING OVERRIDE

SYSTEM

SW4

ON OFF

1 = OFF	CONVENTIONAL SYSTEM
2 = OFF	PLENUM FAN DISABLED
2 = ON	PLENUM FAN ENABLED
3 = OFF	SINGLE STAGE COOLING
3 = ON	DOUBLE STAGE COOLING
4 = OFF	SINGLE STAGE HEATING
4 = ON	DOUBLE STAGE HEATING
1 = ON	HEAT PUMP SYSTEM
2 = OFF	O CALL FOR COOL WHEN ENERGIZED
2 = ON	B CALL FOR HEAT WHEN ENERGIZED
3 = OFF	SINGLE STAGE
3 = ON	DOUBLE STAGE
4 = OFF	NO AUX HEAT CONNECTED
4 = ON	AUX HEAT CONNECTED
5 = OFF	NORMAL
5 = ON	ADD-ON

UPSTAGING

SW5

ON OFF

1	2	3	UPSTAGE DELAY
OFF	OFF	OFF	5 MIN NORMAL
OFF	OFF	ON	10 MIN NORMAL
OFF	ON	OFF	15 MIN NORMAL
OFF	ON	ON	20 MIN NORMAL
1	2	3	UPSTAGE ZONES
ON	OFF	OFF	2 AND 3 ZONES
ON	OFF	ON	3 AND 5 ZONES
ON	ON	OFF	3 AND 6 ZONES
ON	ON	ON	4 AND 7 ZONES
4	5	AUX HEAT DELAY	
OFF	OFF	5 MIN EXTRA	
OFF	ON	10 MIN EXTRA	
ON	OFF	15 MIN EXTRA	
ON	ON	20 MIN EXTRA	

G2 RELAY/PURGE

SW6

ON OFF

1	2	3	G2 FAN OUTPUT
OFF	OFF	OFF	WITH 2 STAGES
OFF	OFF	ON	WITH 3 STAGES
OFF	ON	OFF	WITH 2 ZONES
OFF	ON	ON	WITH 3 ZONES
ON	OFF	OFF	WITH 4 ZONES
ON	OFF	ON	WITH 5 ZONES
ON	ON	OFF	WITH 6 ZONES
ON	ON	ON	G2 RELAY AS AN ECONOMIZER
4	5	FAN PURGE	
OFF	OFF	NONE	
OFF	ON	HEATING ONLY	
ON	OFF	COOLING ONLY	
ON	ON	COOLING AND HEATING	

Zone 1	
Zone 2	
Zone 3	
Zone 4	
Zone 5	
Zone 6	
Zone 7	

LED FUNCTIONS : MASTER BOARD

NORMAL	GREEN	PANEL FUNCTIONS NORMAL WHEN FLASHING
DELAY	YELLOW	DELAY ACTIVE WHEN ON
W1	RED	EQUIPMENT POWERED WHEN ON
W2/O/B	RED	" " " " " "
Y1	YELLOW	" " " " " "
Y2	YELLOW	" " " " " "
G1	GREEN	" " " " " "
G2	GREEN	G2 RELAY " " " "
ZONE x 3	GREEN	DAMPER OPEN WHEN ON

LED FUNCTIONS : EXPANDER BOARD

NORMAL	GREEN	EXPANDER BOARD CONNECTED PROPERLY WHEN FLASHING
ZONE x 2	GREEN	DAMPER OPEN WHEN ON

120-1525 Technical Service: (800) 445-8299

24. TERMINAL DESCRIPTIONS

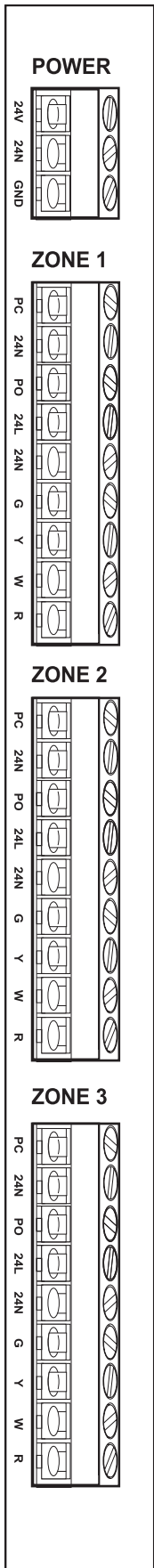

POWER

24V
Live connection from the 24VAC transformer to power the panel.

24N
Neutral or common connection from the 24VAC transformer.

GND
To be connected to a good electrical earth ground.

ZONES 1-3

PC
Power close terminal for the damper.

24N
Neutral or common connection for the damper. Inside the SZD it is connected to the 24N terminal of the zone 24VAC transformer.

PO
Power open terminal for the damper.

24L
Live connection from the zone 24VAC transformer to power the damper.

24N
Neutral or common connection from the zone 24VAC transformer.

G
Connected to the fan output of the zone thermostat. The SZD will react to an electrical connection between G and R as a call for fan from the specific zone.

Y
Connected to the cool output of the zone thermostat. The SZD will react to an electrical connection between G and Y as a call for cool from the specific zone.

W
Connected to the heat output of the zone thermostat. The SZD will react to an electrical connection between G and W as a call for heat from the specific zone.

R
Connected to the R terminal on the zone thermostat. Internally in the SZD it is connected to 24N terminal of the specific zone.

MODE

SWCOM
The terminal is shared by all the mode inputs. Internally it is electrically connected via the 2.5Amp poly-fuse to the 24N terminal of the power terminal block.

HEAT
The SZD will react to an electrical connection between this terminal and SWCOM as a request to switch into the heat only mode.

COOL
The SZD will react to an electrical connection between this terminal and SWCOM as a request to switch into the cool only mode.

OFF
The SZD will react to an electrical connection between this terminal and SWCOM as a request to switch into the OFF mode.

EH
The SZD will react to an electrical connection between this terminal and SWCOM as a request to switch into the emergency heat mode.

FAN
The SZD will react to an electrical connection between this terminal and SWCOM as a request for a system wide continuous fan.

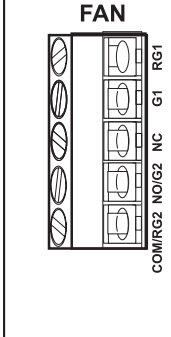
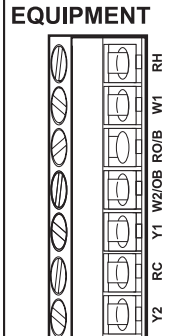
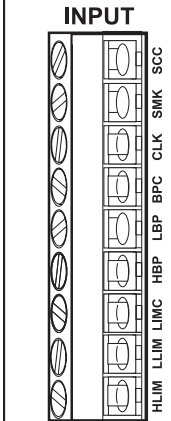
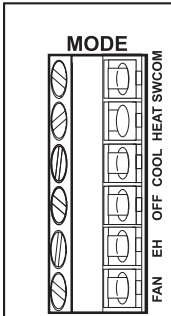

INPUT

SCC
This is the common terminal shared by the smoke and clock inputs. Internally it is electrically connected via the 2.5 Amp poly-fuse to the 24N terminal of the power terminal block.

SMK
The SZD will react to an electrical connection between this terminal and SCC as if smoke were detected by the smoke detector.

CLK
The SZD will react to an electrical connection between this terminal and SCC as if the clock were switched into the unoccupied mode.

BPC
This is the common terminal shared by the HBP and LBP inputs. Internally it is electrically connected via the 2.5 Amp poly-fuse to the 24N terminal of the power terminal block.

LBP
The SZD will react to an electrical connection between this terminal and BPC as if the outdoor temperature were below the low balance point.

HBP
The SZD will react to an electrical connection between this terminal and BPC as if the outdoor temperature were above the high balance point.

LIMC
This is the common terminal shared by the LLIM and HLIM inputs. Internally it is electrically connected via the 2.5Amp poly-fuse to the 24N terminal of the power terminal block.

LLIM
The SZD will react to an electrical connection between this terminal and LIMC as if the temperature in the duct were below the low limit.

HLIM
The SZD will react to an electrical connection between this terminal and LIMC as if the temperature in the duct were above the high limit.

EQUIPMENT

RH
Connected to the R terminal from the heating equipment. This terminal can be electrically disconnected from RO/B by removing the shunt positioned at the top of this terminal block.

W1
When the Deluxe panel calls for heat it electrically connects the W1 terminal to the RH terminal.

RO/B
Connected to the R terminal from the reversing valve. This terminal can be electrically disconnected from RH by removing the shunt positioned at the top of this terminal block.

W2/OB
In the case of a two stage conventional heating system this terminal will be electrically connected to the RO/B terminal when there is a call for second stage heat. If the system is configured as a heat pump system and depending on the set up of DIP switch number 2 of SW4, this terminal will be connected to RO/B when the heat pump is switched it either cool (O) or heat (B) mode.

Y1
When the Deluxe panel calls for first stage of cool or a first stage of heat in a heat pump system, it electrically connects the Y1 terminal to the RC terminal.

RC
Connected to the R terminal on the cooling or heat pump equipment.

Y2
When the Deluxe panel calls for second stage of cool or a second stage of heat in a heat pump system, it electrically connects the Y2 terminal to the RC terminal.

FAN

RG1
Connected to the R terminal on the fan. This terminal can be electrically disconnected from COM/RG2 by removing the shunt positioned at the bottom of this terminal block.

G1
When the Deluxe panel calls for fan or first stage of fan, it electrically connects the G1 terminal to the RG1 terminal.

NC
This terminal normally is used only in the economizer system. In the default mode it is electrically connected to the COM/RG2 terminal.

NO/G2
This terminal can be configured by DIP switch numbers 1, 2 and 3 of SW6 as an output to an economizer. In the default mode it is electrically disconnected from the COM/RG2 terminal. If this terminal is used as a second stage output to a fan it will be electrically connected to COM/RG2 whenever the panel calls for a second stage fan.

COM/RG2
Used as the common terminal for the economizer or the R terminal for the second stage fan. This terminal can be electrically disconnected from RG1 by removing the shunt positioned at the bottom of this terminal block.

25. TEST, CHECK, AND STARTUP PROCEDURES

1. After all wiring has been landed to the logic panel, disconnect the RH/RC wire from the panel to the equipment to prevent short cycling during preliminary test/check procedures.
2. Make sure that all selector switches are set in the proper positions. Refer to system setup section in the manual.
3. Place all zone thermostats in the OFF position.
4. Temporarily disconnect any limit or peripheral control inputs.
5. Set SW1 selector switch in normal operation.
6. Set SW2 selector switch in auto changeover mode.
7. Set SW3 selector switch in intermittent fan operation.
NOTE: Remember to set SW1, SW2, and SW3 selector switches back to desired operation after test, check, and startup procedures are completed.
8. Power Up Test:
Energize the logic panel transformer and confirm the following:
 - On initial power-up the NORMAL operation LED begins to flash.
 - All zone damper LEDs are ON (damper open indication).
9. Zone thermostat inputs and equipment outputs test:
Using a jumper wire, confirm the following for each zone terminal:
 - Jumper R and G. Push and hold time delay override button SW7.
 - a. Current zone damper LED ON
 - b. All other zone damper LEDs OFF
 - c. G equipment output LED ON
 - Jumper R and Y. Push and hold time delay override button SW7.
 - a. Current zone damper LED ON
 - b. All other zone damper LEDs OFF
 - c. Y equipment output LED ON
 - d. G equipment output LED ON
 - Jumper R and W. Push and hold time delay override button SW7.
 - a. Current zone damper LED ON
 - b. All other zone damper LEDs OFF
 - c. W equipment output LED ON
 - d. G equipment output LED ON (heat pump applications only — in conventional heat/cool applications, the LED will not come on in heat mode).

NOTE: When the logic panel is set up for heat pump equipment, confirm that the reversing valve O/B LED is ON in proper sequence with SW4 switch configuration.
10. Start Up:
 - Deenergize the logic panel transformer.
 - Reset SW1, SW2 and SW3 back to desired operation mode.
 - Reconnect any limit or peripheral control wires.
 - Reconnect the equipment RC/RH wire.
 - Energize both the logic panel transformer and power supply for the dampers and thermostats.
 - Activate each zone thermostat in the proper mode of operation and adjust set points accordingly.
 - Allow logic panel to sequence through initial start up time delays.

26. TROUBLESHOOTING GUIDE

PROBLEM	POSSIBLE CAUSE	SOLUTION
No heating/cooling in house	Zone thermostat(s)	Set COOL/OFF/HEAT switch on the thermostat(s) to the proper setting.
	Faulty heating/cooling Equipment	Troubleshoot equipment according to manufacturer's instructions.
	Faulty thermostat	Troubleshoot thermostat according to manufacturer's instructions. Replace if necessary.
	Faulty zone control panel (NORMAL LED not flashing)	Replace if necessary.
	Improper remote switch selector setting (if installed)	Ensure the switch is set to a mode of operation that allows the requested call to be serviced.
No heating/cooling in zone	Balancing damper closed	Check all balancing dampers in the same duct as the motorized zone damper; closed balancing dampers should be readjusted.
	Zone registers closed	Check all zone registers; closed registers should be readjusted.
	Faulty thermostat	Troubleshoot thermostat according to manufacturer's instructions. Replace if necessary.
	Faulty zone control panel (NORMAL LED not flashing)	Replace if necessary.

27. LOGIC PANEL SPECIFICATIONS

Panel Power Requirements	Dedicated 24 VAC, 24VA Transformer
Minimum Power Consumption	250mA (Master Board Only)
Maximum Power Consumption	400mA (Master + 2 Expander Boards)
Maximum Current to Dampers	2.50 amps @ 68°F (20°C)
Functional Ratings	14°F to 158°F (-10°C to 70°C)
Storage Ratings	-4°F to 158°F (-20°C to 70°C)

NOTE: It is recommended that the logic panel be installed in a conditioned environment. If installed in an unconditioned space, the current limiting devices used in the panel are temperature dependent. The following linear relationship exists between the ambient temperature and the operating current.

Ambient Temperature	Maximum Current
-4°F (-20°C)	3.40 amps
32°F (0°C)	2.98 amps
68°F (20°C)	2.50 amps
104°F (40°C)	2.03 amps
122°F (50°C)	1.80 amps
140°F (60°C)	1.58 amps
158°F (70°C)	1.35 amps
Humidity	20% to 90% relative humidity
Dimensions	8.75" x 9.5" x 1.75" (22 cm x 24 cm x 45 cm)
Weight	3 lb. (1.36 kg)
Wiring	#18 gauge thermostat wire
Minimum On/Off Times	4 minutes in cooling mode 2 minutes in heating mode
Protection	Permanent poly-fuse protection for outputs Equipment short cycle protection

28. WARRANTY INFORMATION

Limited One Year Warranty

Robertshaw warrants to the original purchaser for a period of one year from the date of purchase. This warranty states that the product and component parts will be free from defects in workmanship and materials. Your dealer will provide free replacement of your panel upon proof of purchase.

Exclusions

This warranty does not apply in the event of misuse, abuse or as a result of unauthorized alterations or repairs. The manufacturer will not be liable for any consequential damages including, without limitation, damages resulting from defects, loss of use, or misuse.

Compliance

This equipment, if installed in strict accordance with the manufacturer's instructions, complies with the limits for a Class B computing device pursuant to Subpart J of Part 15 of FCC rules. This equipment, if installed in strict accordance with the manufacturer's instructions, complies with CE rules.

NOTES:

NOTES:



Uni-Line North America
P.O. Box 2000
Corona, CA 92879-1736
United States of America

Telephone +1 909 734 2600
Fax +1 909 737 8261

Canadian Division
5785 Kennedy Road
Mississauga, Ontario L4Z 2G3
Canada

Telephone +1 905 890 5811
Fax +1 905 890 6098