

# 35Amp Solar MPT/PWM Charge Controller and Display Part#SEDCM



## SUNEXPLORER III™



Manufactured by: Atkinson Electronics, Inc.

# Table of Contents

Diagrams.....	<b>1</b>
Description .....	<b>2</b>
Specifications .....	<b>3</b>
Description of Operation .....	<b>4</b>
Charging Graph & Stage Description .....	<b>5</b>
Wiring Diagram.....	<b>6</b>
Choosing a Mounting Location.....	<b>7</b>
Installation Instructions.....	<b>8</b>
Battery Type, Temperature Scale & Set Up Instructions .....	<b>9</b>
Mounting Instructions .....	<b>10</b>
Power Up Initializations Routine.....	<b>11</b>
LED Indication .....	<b>12</b>
User Select Button Installations.....	<b>13</b>
Trouble Shooting Tips .....	<b>14</b>
Fault Indications & Cleaning Tips .....	<b>13</b>
Appendix A .....	<b>16</b>
Appendix B.....	<b>17</b>
Limited Warranty.....	<b>18</b>
Appendix C.....	<b>19</b>



# Diagrams

## FRONT SIDE

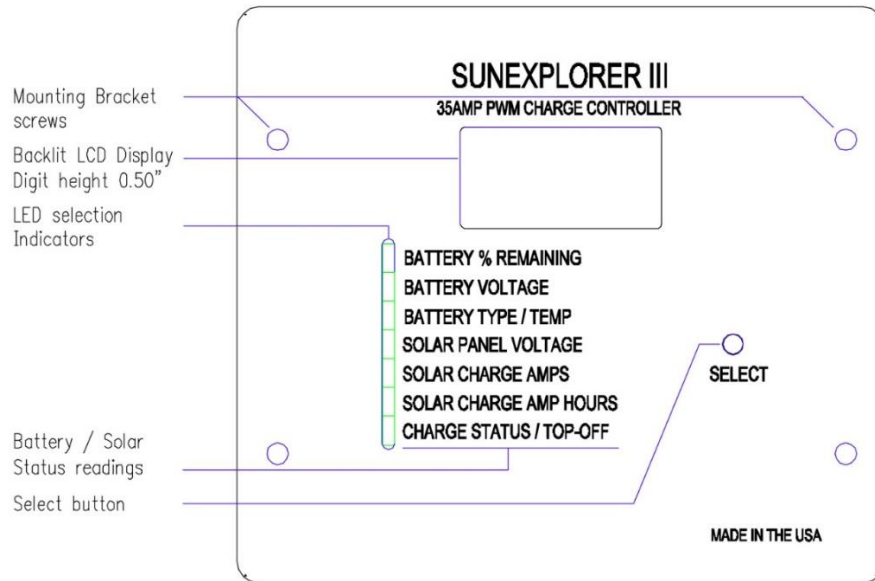

## BACK SIDE

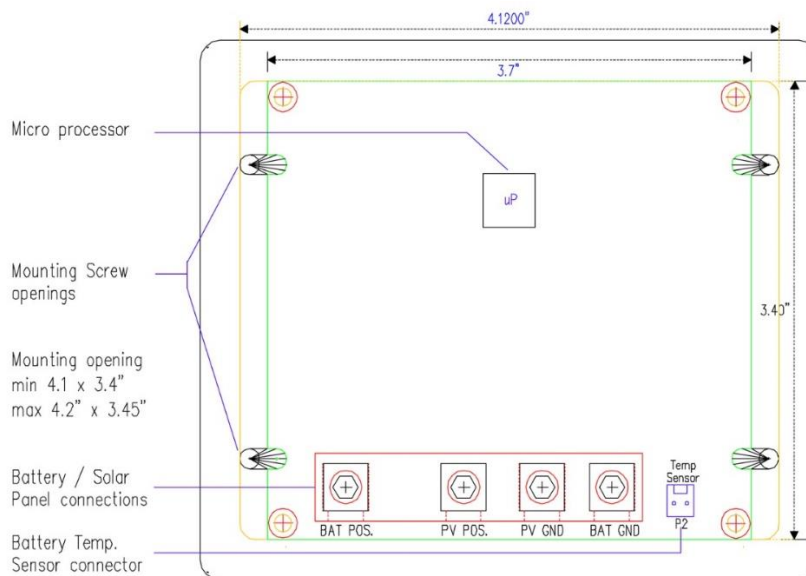

# Description

---

## FRONT SIDE OF CONTROLLER

- **4 MOUNTING BRACKET SCREWS:** Bracket clamps the wall paneling between faceplate and brackets, NO screws to come loose.
- **BACKLIT LCD DISPLAY:** 3 DIGITS 0.50" tall for easy reading.
- **LED SELECTION INDICATORS:** Lit red & green LED indicates which position is selected.
- **BATTERY/SOLAR STATUS READING:**
  - ✓ **Battery:** Voltage, battery & temperature.
  - ✓ **Solar:** Panel voltage, charge Amps & Amp hours.
  - ✓ **Charge Status:** Top off.
- **SELECT BUTTON:** Allows user to scroll thru LED positions.
- **CHARGE STATUS/ TOP-OFF POSITION:**

**Charge Status LED color indicates following:**

  - ✓ **OFF:** Night mode - Solar voltage insufficient to charge battery(s).
  - ✓ **GREEN:** Controller is in the float stage of the four stage charge routine.
  - ✓ **RED:** Controller is in the bulk/absorption stage of the charge routine.
  - ✓ **BLINKING GREEN:** Controller is in the auto bulk/absorption stage as a result of battery voltage dropping below 13.0V while in float stage for 5 minutes.
  - ✓ **ORANGE:** Equalization Charge.

## BACK SIDE OF CONTROLLER

- **DISPLAYS MICRO PROCESSOR:** Microprocessor controls all displays and read-out functions.
- **4 MOUNTING BRACKET SCREWS:** Bracket clamps the wall paneling between face plate and brackets, no screw to come loose.
- **MOUNTING OPENING SIZE:**
  - ✓ Minimum opening size is 4.10" x 3.40" +/-0.10"
  - ✓ Maximum opening size is 4.20" x 3.45" +/-0.10"
- **BATTERY/SOLAR PANEL CONNECTIONS:** 4 hex screw lugs that will accept a 6-12 Awg wire. (Batt + Solar + Solar – and Batt-). Torque and Hex screws to 16 inch pounds (1.8N.m) recommend using NoAlox on Battery & Solar connections to avoid oxidation problem due to moisture.
- **BATTERY TEMPERATURE SENSOR CONNECTORS:** Input has two functions:
  - ✓ When the controller is powered with the shorting shunt on the sensor connector, the SunExplorer III allows the installer/ user to select the battery type, when the shunt is removed the controller stores the battery type selected.

When a LM335T-x sensor is mounted in the battery box and connected to the controller, the charge rate is adjusted based on temperature of the battery.



## Specifications

---

Size & Weight:	4.0" H x 4.70" W x 0.75" D, 5.9 ounces
Mounting: brackets	3.5" H x 4.15" W cutout opening with mounting
Power:	9 to 16 DC from battery
Maximum Charging Current (Amps):	35 Amps from solar panel array (620 watts max.)
Maximum Charging Solar Voltage:	25VDC (open circuit voltage) from solar panel array
Bulk/Absorption Voltage:	14.4VDC / 14.4V/ 14.0V Wet Lead-Acid/ AGM/ Sealed/Gel
Float Voltage:	13.7V (Wet Lead-Acid/ AGM/ Sealed/ Gel)
SunExplorer's Idle Current Draw:	15mA normal mode 35mA with back light on
Display:	3 digit LCD to 999 or 99.9 with decimal 0.5" character height
Battery Percent Remaining:	12.8V = 100%, 12.55V = 75%, 12.4V = 50% 11.75V = 25%, 10.5V = 0%
Low Battery:	Detects low battery @ 11.8V
Battery Type:	Wet, AGM, Sealed/ Gel (default is wet battery)
Temp Sensors:	LM335T PT (Required for temperature compensation) Available in 96" or 192" wire lengths
Temperature Compensation:	24mV/°C .13mV/°F
Solar Voltage:	Display range 0 to 25.0VDC
Solar Charge:	Display range 0 to 35.0 Amps
Solar Amp Hours:	Display 0 to 999 accumulated
Solar Charge Status:	7 <sup>th</sup> LED position not lit – not charging – night mode Red LED: Bulk charging stage Green LED: Floating charging stage Orange LED: Equalization charging stage
Temperature:	-10 to 55°C/ -14 to 131° F



## Description of Operation

---

The SunExplorer III is a six (6) stage, micro-processor based, Pulse Width Modulated (PWM), and Multi-Point Tracking (MPT), solar charge controller. The controller connects between the solar panels and 12VDC storage batteries to regulate charge. The SunExplorer III controller maintains maximum charging rates throughout each of the charging stages, maintains battery life by protecting it from over charging or under charging by regulating the PWM rates, and disconnects the batteries at night to prevent discharge thru the solar panels. The SunExplorer III provides an automatic equalization stage for lead-acid (wet) batteries that are drained down to 12VDC.

The SunExplorer III monitors both the battery and solar panel voltages and determines when and how to charge the battery. Each morning, when solar panels produce a voltage greater than 10VDC the display portion of the controller wakes up and checks for a low battery/ equalization flag and the current battery voltage to determine which charging stage to enter, soft charge (Batteries less than 10VDC) or bulk charge. When the solar panel voltage reaches 16.0VDC the controller enters the bulk charging stage, charging the battery up to the bulk charge voltage. The SunExplorer III then enters the absorption stage and begins modulating its charging PWM algorithm to maintain the bulk charge voltage. The absorption period is based on the battery voltage before it started charging. Once it completes the absorption phase it then drops into the float stage, maintaining the battery voltage at 13.7V by adjusting its PWM algorithm to compensate for varying solar (sunny/cloudy) and DC load conditions to maintain float voltage. If solar or load conditions are such that the battery voltage is pulled below 13.0VDC for more than 10 minutes an auto boost flag is set and when the conditions improve and the battery voltage returns to the float voltage the controller sees the boost flag and performs the auto boost routine then returns to the float stage. When the solar panels output drops below 10.0 volts the SunExplorer III enters its night or end of day mode.

### **The SunExplorer III performs the following functions:**

1. Monitors both battery and PV voltages to determine when to begin its charge routine each day and how it is to progress through its charging stages.
2. Monitors the battery temperature sensor and compensates for rising or falling battery temperatures (requires battery temperature sensor AEI-LM335t).
3. Monitors for low battery voltage, when detected it will blink the battery voltage LED and display the battery voltage.
4. Compensates for varying solar (sunny/cloudy) and DC loads conditions by adjusting its PWM charging algorithms to maintain an optimum float charge.
5. Auto boost feature will occur when the controller cannot maintain float voltage due to excessive loads and the battery voltage is pulled down below 13VDC. Charge Status LED Indicates which stage the controller is in: Red - Bulk and Absorption, Green - Float, Orange - Equalization, Blinking Green - nearing end of day, Charge Status LED OFF – Night



# Charging Graph & Stage Description

---

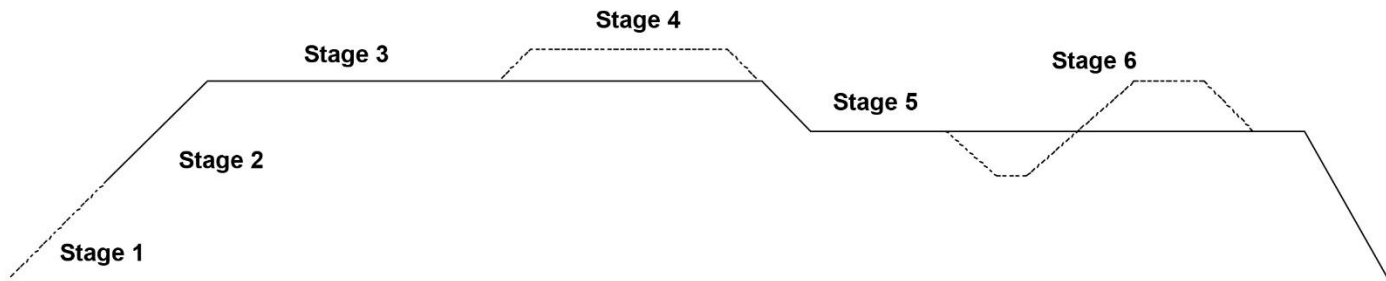

## Stage 1 – Soft Charge

When the batteries are discharged below 10VDC, the controller will softly ramp the battery voltage up to 10VDC before applying the full bulk.

## Stage 2 – Bulk Charge

Maximum charge current from solar panels until the batteries rise to the absorption voltage.

## Stage 3 – Absorption Charge

Battery voltage is maintained at a constant voltage using PWM technology to finish charging the batteries to a 100% of charge.

## Stage 4 – Battery Equalization Charge

Battery Equalization is only available for (WET) flooded lead acid battery. When the battery voltage has dropped below 12.0VDC the controller will automatically run the equalization stage to bring the internal cells of the batteries to an equal state and reverse the loss of capacity to being discharged below 12.0VDC once every 28 days.

## Stage 5 – Float Charge

The Batteries are fully charged at this point and are maintained at a safe voltage level. During the float charge the controller is constantly adjusting its PWM control to adjust for varying solar charging currents and trailer loads to maintain a float voltage of 13.7VDC.

## Stage 6 – Automatic Boost Charge

When the controller is in float charge and the trailer loads are greater than the solar charging current and the battery voltage is pulled below 13VDC, the controller will set an auto boost flag and when loads are reduced, it will perform a bulk/absorption charge restoring the batteries to 100% and then return to the float charge.



# Wiring Diagram

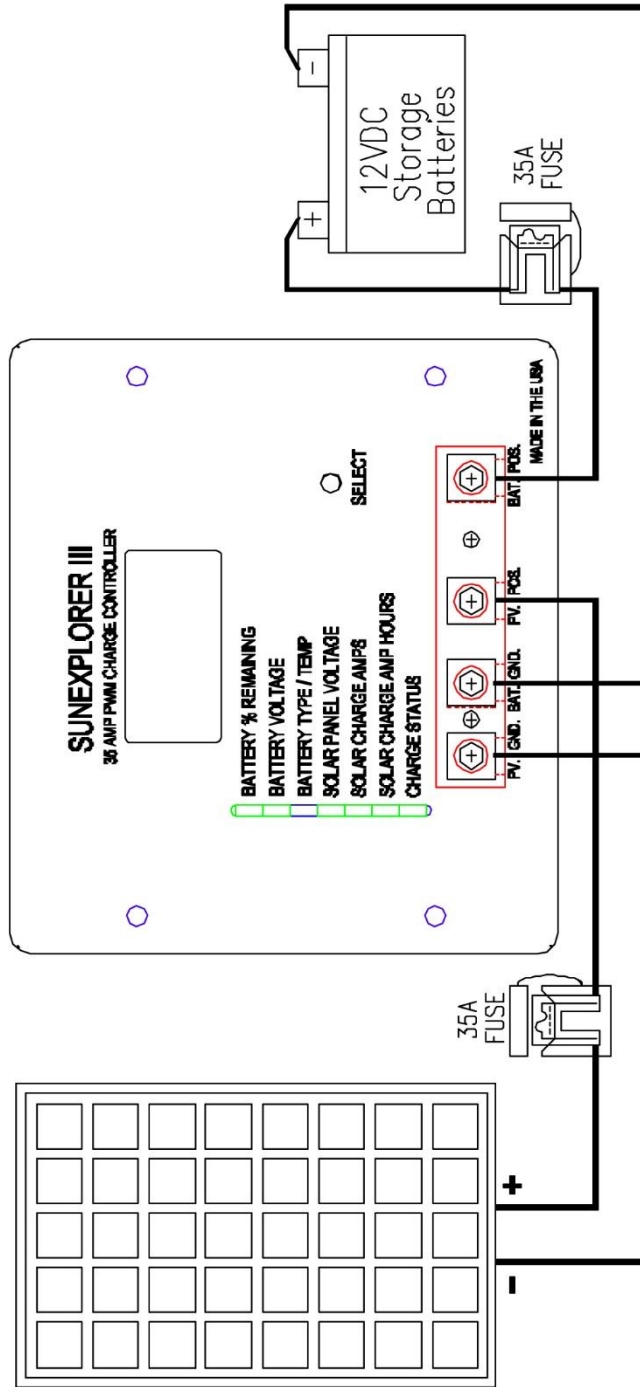



## Choosing a Mounting Location

---

Most trailer manufacturers have a recommended location that provides easy accessibility for running wires from the charge controller to the batteries and solar panels mounted on the roof. The SunExplorer III-35 should be mounted:

- As close to the batteries as Feasibly possible, avoid long wire runs >10 feet, longer runs have higher voltage drops when charging.
- Where there is sufficient depth behind the controller (min. depth 1 1/4")
- To allow for the battery and solar panel wires and ventilation.
- Away from moisture and heat sources (sinks, shower, stoves etc.).
- The controller needs to be protected from steam, water and spray cleaners that can get behind the faceplate, causing damage to the unit.
- Indoors away from doors and windows, protected from weather.

## WARNINGS – IMPORTANT

---

- This charge controller is designed for indoor use only and should never be exposed to moisture (water or rain). It will damage the electronics.
- Electricity can be very dangerous. Installation should be performed only by a licensed electrician or qualified RV service technician.
- When working around batteries, always wear protective eye wear and appropriate clothing, observe all safety precautions of the battery manufacturer. When batteries are charging, they produce hydrogen gas which is highly explosive. Avoid any sparks or open flame when charging.
- Always cover the solar panels with a thick cloth or blanket to block out *ALL* light before connecting the panel wiring to the charge controller. Avoid accidental shorting of the wires or terminals which could cause personal injury or damage to the unit or sparks causing a fire.
- Disconnect all power sources before installation (utility power & batteries)
- Observe correct polarity when installing. Reverse polarity of either the solar panel or battery connections could cause damage to the controller.
- ***Ensure all electrical connections are tight and secure. Torque hex screws to 16 inch pounds, re-torque after ten days of operation to avoid any loose connections that can cause sparks and/or excessive heat.***
- Do not exceed the SunExplorer III-35's Maximum current (Amps) and PV voltage ratings, total of 35 Amps (IMP) and 25.0VDC (VMP). See solar panels electrical ratings info tag found on the back side of the solar panel.

## Tools and Materials needed for Installation

---

- Philips Screwdriver (for mounting bracket screws)
- Torque Allen Wrench (for wire terminals)
- Wire strippers or utility knife
- Small hole saw or utility knife (for cutting opening for flush mounting)

7



## Installation Instructions

---

1. Complete the installation of the solar panels. Follow the solar panel manufacturer's instructions for solar panel mounting and wiring to a weather proof multi panel junction box. Cover panels with an opaque material (several layers of a thick blanket) until wiring is complete.
2. Prepare the site for mounting the controller. Use the cut-out template found in Appendix C to mark the outline of the 4.15" x 3.5" opening for flush mounting of the controller.
3. Select wire type and gauge. (See Appendix B) It is recommended that stranded copper UV resistance wire be used. Wire fatigue and the possibility of a loose connection are greatly reduced by using stranded wire over solid wire. The wire gauge must be able to sustain the rated current (3.5 Amps) as well as minimizing voltage drop. Keeping the distance between PV junction box, the charge controller and batteries, as short as possible, this will minimize the voltage drop.

### Suggested minimum wire gauge and fuse size:

- 300 Watts of Solar Panels # 10 Gauge Wire 25 Amp Fuse
  - 450 Watts of Solar Panels # 8 Gauge Wire 35 Amp Fuse
  - 600 Watts of Solar Panels # 6 Gauge Wire 40 Amp Fuse  
(25ft. Maximum Cable Length from solar panels to battery bank.)
4. If possible use red and black cables or mark both ends of each cable with colored tape to indicate which cable is positive and negative, to avoid possibly hooking the cables up backwards and damaging the controller.
  5. Run the wires from the solar panels and the batteries to the location of where the SunExplorer III controller will be mounted. If a battery temperature sensor is to be used, run it with the set of cable coming from the battery compartment. It is also required that an in-line fuse be installed at the battery location to protect both batteries and controller (for ease of accessibility, see Appendix A). If a wire ever came loose and caused a short, you do not need continuous arcing to cause a fire. **Do not** connect the wires to battery at this time.
  6. The SunExplorer III has four terminals marked as follows: BAT(+), PV(+), BAT(-) , and PV(-). Strip the insulation back 3/8" (9.5mm), insert each wire into the correct terminal, tighten enough to hold the wire, reverify polarity, and then tighten each connection to 16 inch pounds (1.8N.m).
  7. **Do not connect temperature sensor to the controller at this time.** At battery location, **remove fuse from the fuse holder or open the resettable breaker**, then finish connecting the in-line fuse to the controller's battery + wire, and connect the other end to the battery + (pos) terminal. Connect the controller's battery neg (-) wire to the battery neg (-) terminal.



## Battery Type & Temperature Scale Set Up

---

At this point in the installation you need to select your battery type and the temperature reading to be displayed in either °F or °C.

1. Check to make sure the shorting jumper is on the temperature sensor connector. Then insert the recommended fuse (amperage based on total solar panel wattage) into fuse holder. This powers the charge controller. The SunExplorer III controller will power up displaying "888" for 3 seconds then it will enter setup mode, displaying the battery type and temperature. The battery/temp LED will be illuminate.
2. The display read out will show "FLF", the factory default setting if being powered for the first time. FL = (WET) Flooded lead acid battery type and F= Fahrenheit temperature scale. If this is correct go to step 7.
3. If the display doesn't match your system, press and hold the select button for 5 seconds, the left two characters will flash and rotate through the 3 battery types: FL=(Wet) Flooded cell, GL = Gel Cell and AG = AGM cell. It will show each for 5 seconds.
4. When the display is showing correct battery type press and hold the select button for 5 seconds, this stores the battery type, the left two characters stop flashing and the right character will begin flashing and alternate between the two temperature scales, F=Fahrenheit and C=Celsius.
5. When it shows the temperature scale you want, press and hold the select button for 5 seconds, this stores the temperature type and stop flashing the display and battery type/Temperature LED.
6. If not satisfied with your selection, repeat steps 3 through 5.
7. If you're satisfied with the battery type and temperature scale, remove shorting jumper from the temperature sensor input pins and attach it to this manual, you will need it if you change your battery type in the future. The SunExplorer III exits the setup mode.
8. If you installed to optional battery temperature sensor, connect it to the temperature sensor terminal. The Display now indicates battery temperature.
9. If you didn't install the optional temperature sensor the display indicates the battery type and temperature scale you selected.
10. Remove fuse from the in-line battery fuse holder to power down the controller. Now it is time to complete the mounting instructions.



## Mounting Instructions

1. Using a Phillip screw driver loosen the four mounting bracket screws until they reach the stops. Angle the screws and brackets inward as shown below.

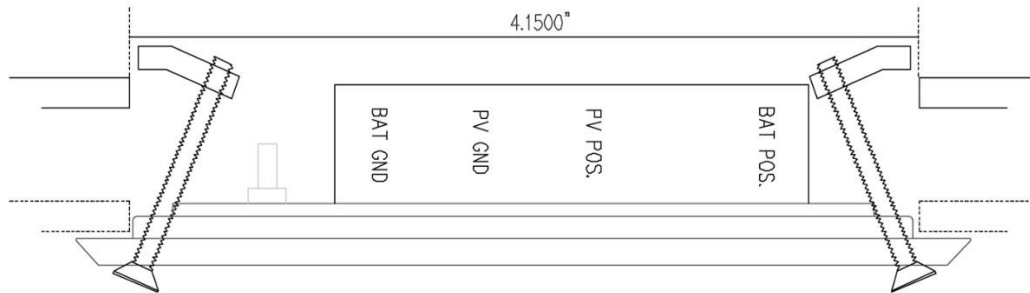

2. Carefully work the wiring into the wall, and insert the mounting bracket into the opening, adjust the face plate to be parallel to the wall surface.

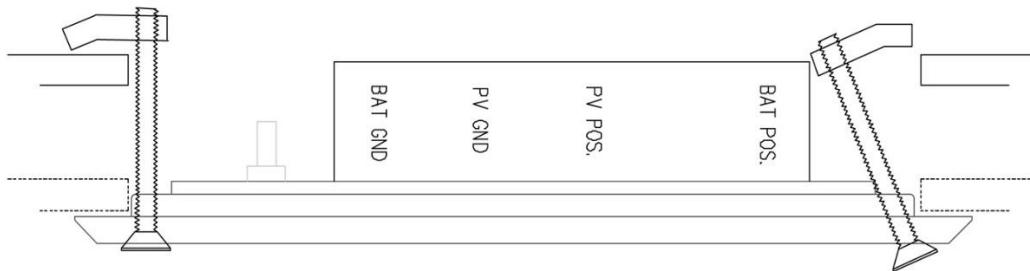

3. Center the controller in the opening against the wall, using a Philips screw driver, tighten each screw 10 to 14 full turns. This brings the mounting clip evenly toward the wall and face plate.

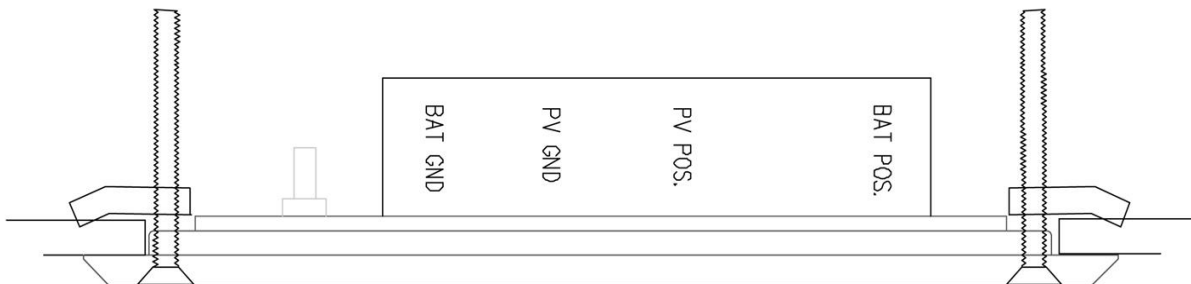

4. Adjust each screw until it comes in contact with the wall. Readjust the face plate if needed to align or center it in the opening. Now tighten all four screws, so that the plate is secure against the wall. DO NOT over tighten the screws.

## Power Up Initialization Routine

---

Now that the installation of the SunExplorer III controller is complete, re-insert the fuse into the battery fuse holder to power the controller. If Powering up for the first time after installation or after replacing a battery, the SunExplorer III runs thru the following sequence: ***PV panels are still covered from installation process.***

1. When first powered the SunExplorer III display will indicate 88.8 and back light will turn on. The display will indicate the following, each for 3 seconds,;
  - The software revision..... "1.2"
  - The rated system voltage....."12"
  - The rated maximum current....."35"
2. The controller will then cycle thru the seven display positions, lighting the corresponding LEDs, displaying eleven readings, each for 3 seconds.
  - Battery % remaining ..... "100" % (Actual reading)
  - Battery voltage..... "12.9" V (Actual reading)
  - Battery type / Temperature
    - "FL.F" (Flooded Battery.....Fahrenheit temperature scale)*
    - "GL.C" (Gel Battery..... Celsius temperature scale)*
    - "AG.F" (AGM Battery..... Fahrenheit temperature scale)*
    - Battery Temperature "77"°F (Displays actual temperature, if temperature sensor is connected)*
  - Solar Voltage "LPu" (Low PV voltage, panels are still covered or its night time) (example "19.5" V, if panels are uncovered and its day time)
  - Solar Charge Amps....."0.0" (Still in night mode) (example "25.0" Amp, if panels are uncovered)
  - Solar Charge Amp Hours " 0.0" (unit has begun to charge)
  - LED Charge Status:
    - LED GREEN night mode....."n\_c"*
    - Blinks RED bulk charge....."bch"*
    - Blinks RED absorption charge....."Ach"*
    - Blinks GREEN float charge....."Fch"*
    - Blinks GREEN auto boost enabled..."AbE"*
    - Blinks ORANGE Equalization....."Ech"*
    - Blinks RED Soft charge....."Sch"*







Once the controller has run thru the power up sequence, the controller will return to normal mode, returning to battery % remaining position, displaying the charge of the battery, and will blink the LED once every 10 seconds, indicating it in night mode (solar panels are still covered). Now remove the blanket or material covering the solar panels. If the panel voltage is greater than 16.0VDC the charge controller will enter the bulk charge stage, causing the charge status LED to lite red and blink if in soft charge or be solid for bulk charge. The back light will be lit for 30 seconds and then turn off and the battery % remaining reading will still be indicated on the LCD display.



## LED Indication

---

The SunExplorer III controller has seven LEDs, six that only illuminate green, and one LED that can illuminate red, green, & orange depending on the charge stage it is in. Each LED and text correspond to what is being indicated on the LCD display screen.

	LCD displays:
 <b>BATTERY % REMAINING</b>	0 to 100%
 <b>BATTERY VOLTAGE</b>	8 to 16.0 VDC
 <b>BATTERY TYPE / TEMP</b>	One of: FL, AG, GL / °F or °C then 77'
 <b>SOLAR PANEL VOLTAGE</b>	0 to 25.0VDC
 <b>SOLAR CHARGE AMPS</b>	Charge <1 Amp, 1 to 40.0 Amps
 <b>SOLAR CHARGE AMP HOURS</b>	0.0 to 999
 <b>CHARGE STATUS</b>	One of 7 charging conditions. (n_c, Sch, Bch, Ach, Ech, Fch, AbE)

When the controller goes into night mode, the battery % remaining LED will blink once every 10 seconds. When morning arrives and the solar panel voltage rises above 10VDC the LED will stop blinking even though the controller has not gone into bulk charge mode. When the solar panel voltage increases to 16VDC it will enter the bulk charge stage lighting the charge status LED red.

When the battery has charged to the bulk/absorption voltage threshold the controller enters the absorption charge stage, charge status LED remains red. If you scroll down to the charge status position the LED will blink red and LCD displays 'Ach'. Once the absorption time has been satisfied the controller enters the Float stage.

If the controller is in the float stage of charge and the charge status LED is blinking, it indicates that the controller's PWM rate is at 100% and unable to maintain a 13.7VDC float voltage. This could be caused by either or both, solar panels not providing a high enough charge voltage or the trailer battery loads are greater than what the solar panels can supply, thus the battery voltage has dropped below 13.0VDC. When the condition is resolved the controller's status LED is solid. It will then check the PV voltage and if greater than 16V, it will perform an auto boost charge (bulk charge with a 30 minute absorption charge period) then returns to a float charge state.

## User Select Button Instructions

---

1. The SunExplorer III's display will normally revert back to displaying the continuous battery percent remaining after approximately 4 minutes from any other reading.
2. Select button operation:
  - a. Pressing the select button activates the back light for 15 seconds.
  - b. Pressing the select button to advance, also resets the 15 second timer.
  - c. Pressing for 1-2 seconds then release the button, advances to the next reading.
  - d. From the battery % remaining position only, pressing and holding the button will advance the display automatically through each of the readings.
    - i. If the button is released before returning to the battery voltage display, the reading will remain in that position until the display times out (4 min.)
    - ii. If the button is held through all readings and then released after the battery voltage display, the SunExplorer III will enter the scroll mode, advancing to the next reading every 3 seconds, indefinitely.
    - iii. Tapping the button exits the scroll mode.
    - iv. A low battery voltage condition will also exit the scroll mode.
  - e. Display lock mode is available for: Battery voltage, battery temperature, solar panel voltage, solar charge Amps.
    - i. To lock display from timing out and reverting to battery % remaining, advance display to desired position then press and hold the button until the display flashes (approximately 3 seconds).
    - ii. Release the button when the display starts flashing, it will remain indefinitely in that reading or until the select button is pressed again.
    - iii. Advancing to the next reading cancels the lock mode.
    - iv. Low battery voltage also cancels the lock mode.
  - f. Resetting the solar accumulated Amp hour reading zero.
    - i. Pressing and holding the button for approximately 6 seconds will reset the display value. The display starts flashing after 3 seconds, the reading goes to zero after 6 seconds and the display stops flashing.
    - ii. Releasing the button while the display is flashing cancels the reset. It will stop flashing and retain its current value after several seconds.
  - g. Manual boost/ battery top off is available only when controller is in float charge stage. Advance to charging status, display will indicate "Fch".
    - i. Press and hold the select button the display will flash "Fch" 4 times, telling the charge controller to enter the charge routine. When controller enters charge mode the green status LED turns RED and the display indicates "bch", 3 second later display jumps to solar charge Amps and shows the charging current for 10 seconds, then to battery voltage showing the battery voltage, then it alternates between them until it exits the charge routine or the select button is pressed.



## Trouble Shooting Tips

---

**Problem:** The SunExplorer III display is blank and there are no LEDs lit.

**Solution:** Check the Fuse in the Battery (positive) wire at the battery to see if it has blown. Recommend using a multi meter to Ohm the fuse. If the fuse is good then check the battery voltage at the battery and at the Controllers battery + terminal, they should be the same, above 8.0VDC. If the battery voltage is below 7.5VDC the controller will not function. Make sure the polarity is correct as positive to positive. If there is no voltage reading at the controller battery terminals, the problem is in the wiring between the battery and the controller. Check **ALL** connections from the controller to the battery terminals. Check that **ALL** connections are clean, tight and secure. If you haven't greased the connections, it is Recommended that all power connections between solar panels to controller to batteries be greased with NoALOX 0.5oz.

**Problem:** The SunExplorer III controller is always in night mode, even though it is a bright sunny day. Green LED blinks once every 10 seconds.

**Solution:** Using the SunExplorer III's display scroll down to Solar panel voltage, if the solar panel voltage is less than the minimum required voltage to charge the batteries it will display "Lpu" low panel voltage.

Check to see if something is covering or blocking the sun light from reaching the solar panels. Check to make sure the panels are not too dirty to supply a high enough voltage for the controller to go into charge mode. If you fused the positive wire from the solar panels, check to see that the fuse is good. If the fuse is good, then measure the solar voltage at the controller PV terminals, it should be greater than 16.0VDC. If you don't have a voltage present, then check each solar panel to make sure they are producing a voltage. If you have multiple panels disconnect one at a time and measure its output voltage, it only takes one shorted solar panel to bring the whole system down.

**Problem:** The SunExplorer III's battery voltage reading is different from what I'm reading with my multi meter.

**Solution:** The SunExplorer III's reads both the battery voltage and solar panel voltage every second to know the true battery voltage (without being pulled up while being charged, and the open solar collector voltage to know what the voltage the panels are producing to know when to charge or shut down for the night. Battery voltage should be within 0.2VDC of the battery voltage when not charging.





## Fault Indication

---

**Fault 1 – Low battery voltage.** The SunExplorer III display has advanced to the battery voltage location and blinks both LED and display reading. This occurs when the battery voltage has dropped to 11.8VDC, a level that could start to damage your batteries. This generally occurs at night when the SunExplorer III cannot charge the batteries. Recommend turning off all loads, plug into shore power or use a generator to charge the batteries.

**Fault 2 – Battery high temperature.** The SunExplorer III display advances to battery temperature location and blinks both LED and battery temperature and the SunExplorer III backs off the charging current to prevent further heating of the batteries. Once the battery temperature drops below 125 degrees F, the SunExplorer III will regulate the charge to keep the battery(s) temperature from increasing. Once the temperature has dropped enough to resume normal PWM charge rate the display will stop flashing.

## Cleaning Tips & Warnings

---

Do not spray water or cleaning solution directly on the face plate or LCD of the SunExplorer III-35. The liquid could run between the face plate and the LCD on to the circuitry of the SunExplorer III-35 circuit board causing damage to the electronics and **WILL VOID THE WARRANTY!** Recommendation for cleaning SunExplorer III: Apply water or cleaning solution to a soft cloth and spot clean the face plate as needed.



Recommended grease for all power connections between photo-voltaic panels, SunExplorer's charge controller and battery bank.

Brand: IDEAL No ALOX 0.5oz  
Available at most hardware stores.

## Appendix A

---



When selecting the correct amperage rating for your in-line circuit breaker, first determine the maximum current output of your solar panel array by adding up the current at maximum Power (Imp) for each panel, then round up to the next standard amperage size.

Example: (3) 150watt panels, Imp = 8.5Amps ea. Total Imp. = 25.4Amps

Recommended fuse or circuit breaker size 30 Amps.

## In-line Fuse examples (Resettable or Blade type)

---



Bussman Maxi in-line fuse holder

Part number: HHX (6 Awg wire)

Bussman Maxi Fuse

Available in 20, 25, 30, 35, 40 & 50 Amps

Part number: CB185-XX

XX= Amp rating



Bussman Resettable Circuit Breaker

Available in 20, 25, 30, 35, 40 & 50 Amps

XX=AMP rating



Automotive Audio Resettable Breaker

Available in 20, 30, 40 & 50 Amps

The fuse, fuse holder and circuit breakers are available at any of the major on-line retailers.

# Appendix B

---

## Amp Verses Wire Gauge Chart





CIRCUIT TYPE		CURRENT FLOW IN AMPS												
Non-Critical 10% VOLTAGE DROP	Critical 3% VOLTAGE DROP	5A	10A	15A	20A	25A	30A	40A	50A	60A	70A	80A	90A	100A
0 to 20 ft	0 to 6 ft	16 AWG	14 AWG	14 AWG	14 AWG	12 AWG	10 AWG	8 AWG	6 AWG	6 AWG	6 AWG	4 AWG	4 AWG	4 AWG
30 ft	10 ft	14 AWG	12 AWG	12 AWG	12 AWG	10 AWG	8 AWG	6 AWG	6 AWG	4 AWG	4 AWG	4 AWG	2 AWG	2 AWG
50 ft	15 ft	12 AWG	10 AWG	10 AWG	10 AWG	8 AWG	6 AWG	6 AWG	4 AWG	4 AWG	4 AWG	2 AWG	2 AWG	2 AWG
65 ft	20 ft	14 AWG	10 AWG	10 AWG	8 AWG	6 AWG	6 AWG	4 AWG	4 AWG	2 AWG	2 AWG	2 AWG	1 AWG	1 AWG
80 ft	25 ft	12 AWG	10 AWG	8 AWG	6 AWG	6 AWG	4 AWG	4 AWG	2 AWG	2 AWG	1 AWG	1 AWG	1 AWG	0 AWG
100 ft	30 ft	10 AWG	8 AWG	6 AWG	6 AWG	4 AWG	4 AWG	2 AWG	2 AWG	1 AWG	1 AWG	0 AWG	0 AWG	0 AWG
130 ft	40 ft	8 AWG	6 AWG	6 AWG	4 AWG	4 AWG	2 AWG	2 AWG	1 AWG	1 AWG	0 AWG	0 AWG	2 0 AWG	2 0 AWG
165 ft	50 ft	6 AWG	6 AWG	4 AWG	4 AWG	2 AWG	2 AWG	1 AWG	1 AWG	0 AWG	0 AWG	2 0 AWG	3 0 AWG	3 0 AWG
200 ft	60 ft	6 AWG	4 AWG	4 AWG	2 AWG	2 AWG	1 AWG	0 AWG	0 AWG	2 0 AWG	3 0 AWG	3 0 AWG	4 0 AWG	4 0 AWG
	70 ft	8 AWG	4 AWG	2 AWG	2 AWG	1 AWG	0 AWG	0 AWG	2 0 AWG	3 0 AWG	4 0 AWG	4 0 AWG		
	80 ft		2 AWG	2 AWG	1 AWG	0 AWG	0 AWG	2 0 AWG	3 0 AWG	4 0 AWG				
	90 ft		1 AWG	1 AWG	0 AWG	0 AWG	2 0 AWG	3 0 AWG	4 0 AWG					
	100 ft		4											

# Limited Warranty

---

Atkinson Electronics, Inc. gives this express warranty (along with extended warranty endorsements, where applicable) in lieu of all other warranties, express or implied, including (without limitation), warranties of merchantability and fitness for a particular purpose. This constitutes Atkinson Electronics, Inc.'s sole warranty and obligation with regard to our products as well as the customer's sole remedy.

Atkinson Electronics, Inc. expressly disclaims all liability and responsibility for any special, indirect or consequential damages or any further loss of any kind whatsoever resulting from the use of our product. The customer's sole and exclusive remedy and the limit of Atkinson Electronics, Inc.'s liability for any loss whatsoever, shall not exceed the purchase price paid by the customer for the product to which a claim is made. Countries or States that do not allow limitations of incidental or consequential damages or on how long an implied warranty lasts, the above limitations may not apply to you. This warranty gives you specific legal rights and you may also have other rights which vary from State to State or Country to Country.

All products manufactured by Atkinson Electronics, Inc. are warranted to be free from defects in material and workmanship in accordance with and subject to the following terms and conditions:

1. This warranty is limited to the original customer only. It cannot be transferred or assigned to third parties unless the intent to transfer to a third party is expressly indicated in a purchase order and/or warranty processing arrangements have been agreed upon in writing by Atkinson Electronics, Inc.
2. Atkinson Electronics, Inc. will correct any defects in material or workmanship which appear within two (2) years from the date of shipment by Atkinson Electronics, Inc. (or its authorized distributors) to the original customer. Atkinson Electronics, Inc. will repair or replace, at our option, any defective products, provided that our inspection discloses that such defects developed under normal and proper use. This warranty does not extend to goods subjected to misuse, neglect, accident or improper installation, or to maintenance or repair of products which have been altered or repaired by anyone except Atkinson Electronics, Inc., unless otherwise stated in writing. Atkinson Electronics, Inc. will correct any defects in material or workmanship of OEM products (designated as such in our catalog or web site) which appear within two (2) years from the product date code or from the factory invoice date, whichever is later.
3. An appropriate charge (25% of product list price) may be made for testing, repairs, replacement and shipping for a returned product which is not defective or found to be defective as the result of improper use, maintenance or neglect.
4. Atkinson Electronics, Inc. will not accept responsibility for any invoiced goods or services that are not covered by an Atkinson Electronics, Inc. written purchase order. Under no circumstances does Atkinson Electronics, Inc. agree to pay for labor or other related expenses associated with the troubleshooting and/or repair of our product without prior specific written authorization.
5. Information in our descriptive literature is based on product specifications that are current at the time of publication.

Product specifications, design and descriptive literature are subject to change as improvements are introduced. Although we announce changes as they occur, we cannot guarantee notification to every customer. Atkinson Electronics, Inc. warrants delivered products to conform to the most current specifications, design and descriptive literature. This warranty policy may be expanded or limited, for particular categories of products or customers, by information sheets published as deemed appropriate by Atkinson Electronics, Inc.



# Appendix C

## Cut Out Template

